

2MBI100N-060

IGBT Module

600V / 100A 2 in one-package

■ Features

- High speed switching
- Voltage drive
- Low inductance module structure

■ Applications

- Inverter for Motor drive
- AC and DC Servo drive amplifier
- Uninterruptible power supply
- Industrial machines, such as Welding machines



■ Maximum ratings and characteristics

● Absolute maximum ratings (at $T_c=25^\circ\text{C}$ unless otherwise specified)

Item	Symbol	Rating	Unit
Collector-Emitter voltage	V_{CES}	600	V
Gate-Emitter voltage	V_{GES}	± 20	V
Collector current	Continuous	I_c	100 A
	1ms	I_c pulse	200 A
	Continuous	$-I_c$	100 A
	1ms	$-I_c$ pulse	200 A
Max. power dissipation	P_c	400	W
Operating temperature	T_j	+150	$^\circ\text{C}$
Storage temperature	T_{stg}	-40 to +125	$^\circ\text{C}$
Isolation voltage	V_{is}	AC 2500 (1min.)	V
Screw torque	Mounting *1	3.5	N·m
	Terminals *1	3.5	N·m

*1 : Recommendable value : 2.5 to 3.5 N·m(M5)

■ Equivalent Circuit Schematic

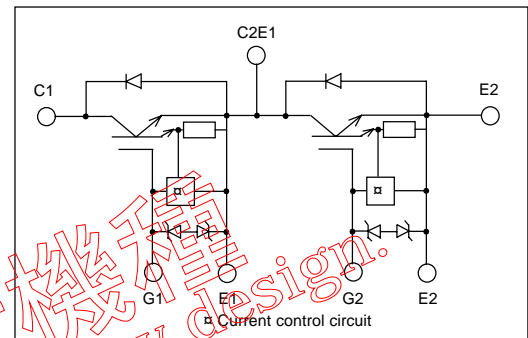

● Electrical characteristics (at $T_j=25^\circ\text{C}$ unless otherwise specified)

Item	Symbol	Characteristics			Conditions	Unit
		Min.	Typ.	Max.		
Zero gate voltage collector current	I_{CES}	—	—	1.0	$V_{GE}=0\text{V}$, $V_{CE}=600\text{V}$	mA
Gate-Emitter leakage current	I_{GES}	—	—	15	$V_{CE}=0\text{V}$, $V_{GE}=\pm 20\text{V}$	μA
Gate-Emitter threshold voltage	$V_{GE(th)}$	4.5	—	7.5	$V_{CE}=20\text{V}$, $I_c=100\text{mA}$	V
Collector-Emitter saturation voltage	$V_{CE(sat)}$	—	—	2.8	$V_{GE}=15\text{V}$, $I_c=100\text{A}$	V
Input capacitance	C_{ies}	—	6600	—	$V_{GE}=0\text{V}$	pF
Output capacitance	C_{oes}	—	1470	—	$V_{CE}=10\text{V}$	
Reverse transfer capacitance	C_{res}	—	670	—	$f=1\text{MHz}$	
Turn-on time	t_{on}	—	0.6	1.2	$V_{CC}=300\text{V}$	μs
	t_r	—	0.2	0.6	$I_c=100\text{A}$	
Turn-off time	t_{off}	—	0.6	1.0	$V_{GE}=\pm 15\text{V}$	μs
	t_f	—	0.2	0.35	$R_G=24\text{ohm}$	
Diode forward on voltage	V_F	—	—	3.0	$I_F=100\text{A}$, $V_{GE}=0\text{V}$	V
Reverse recovery time	t_{rr}	—	—	0.3	$I_F=100\text{A}$	μs

● Thermal resistance characteristics

Item	Symbol	Characteristics			Conditions	Unit
		Min.	Typ.	Max.		
Thermal resistance	$R_{th(j-c)}$	—	—	0.31	IGBT	$^\circ\text{C/W}$
	$R_{th(j-c)}$	—	—	0.7	Diode	$^\circ\text{C/W}$
	$R_{th(c-f)*2}$	—	0.05	—	the base to cooling fin	$^\circ\text{C/W}$

*2 : This is the value which is defined mounting on the additional cooling fin with thermal compound

Characteristics (Representative)

Collector current vs. Collector-Emitter voltage
T_J=25°C

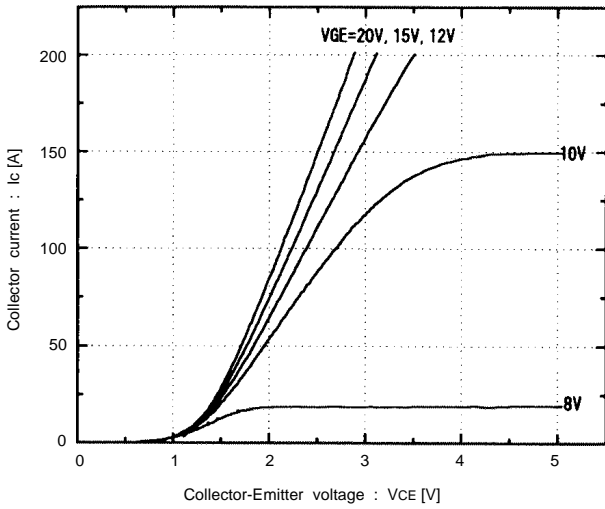

Collector current vs. Collector-Emitter voltage
T_J=125°C

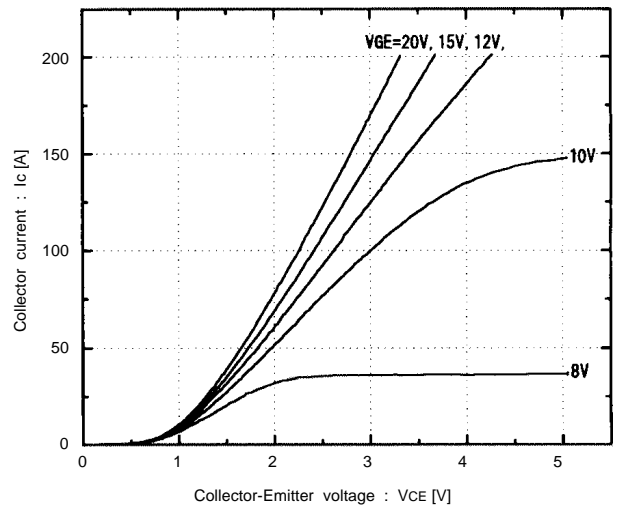

Collector-Emitter vs. Gate-Emitter voltage
T_J=25°C

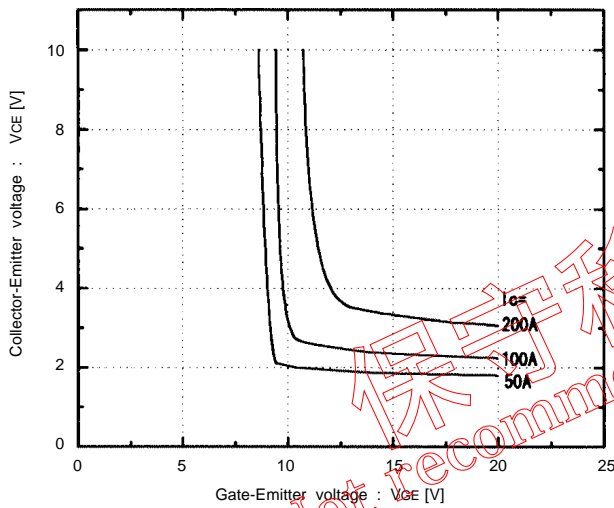

Collector-Emitter vs. Gate-Emitter voltage
T_J=125°C

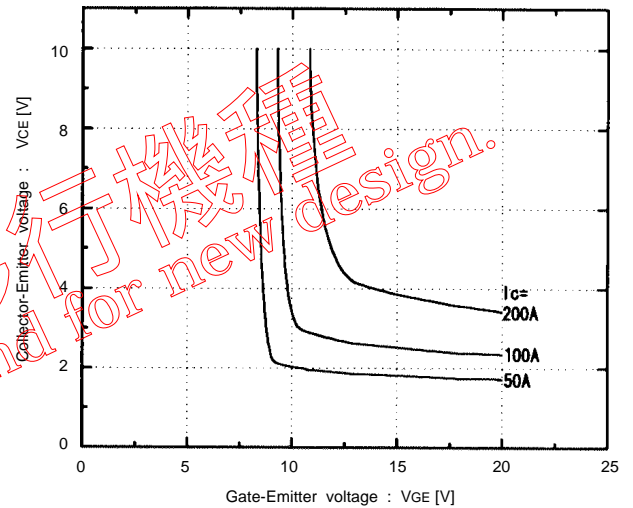

Switching time vs. Collector current
V_{CC}=300V, R_G=24 ohm, V_{GE}=±15V, T_J=25°C

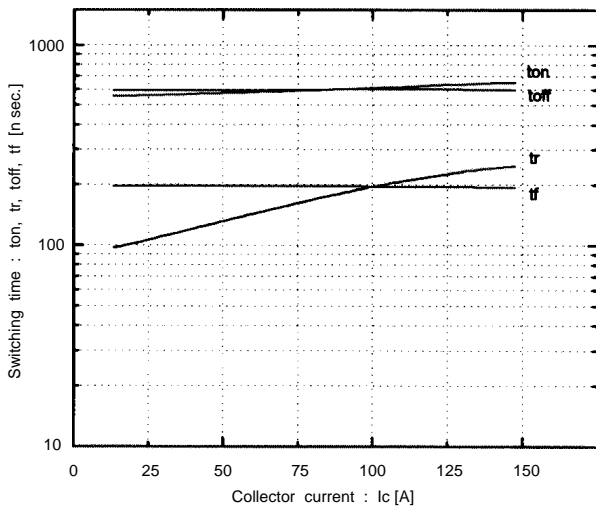

Switching time vs. Collector current
V_{CC}=300V, R_G=24 ohm, V_{GE}=±15V, T_J=125°C

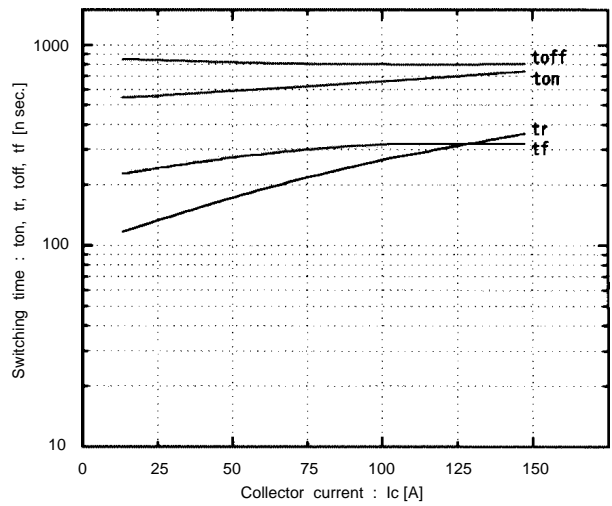

保守移行機種
Not recommend for new design.

Switching time vs. RG
Vcc=300V, Ic=100A, VGE=±15V, Tj=25°C

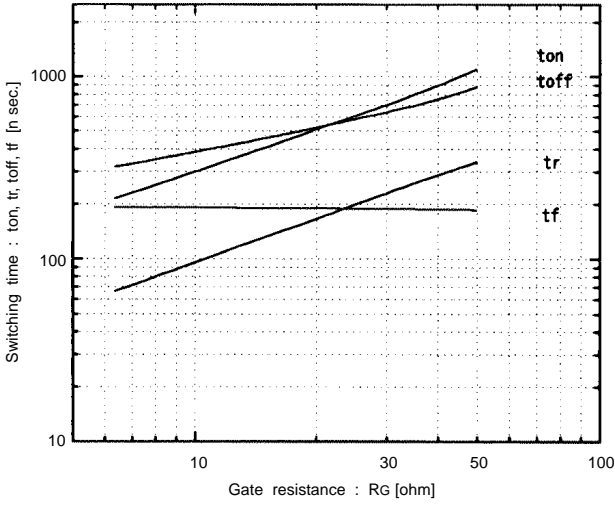

Dynamic input characteristics
Tj=25°C

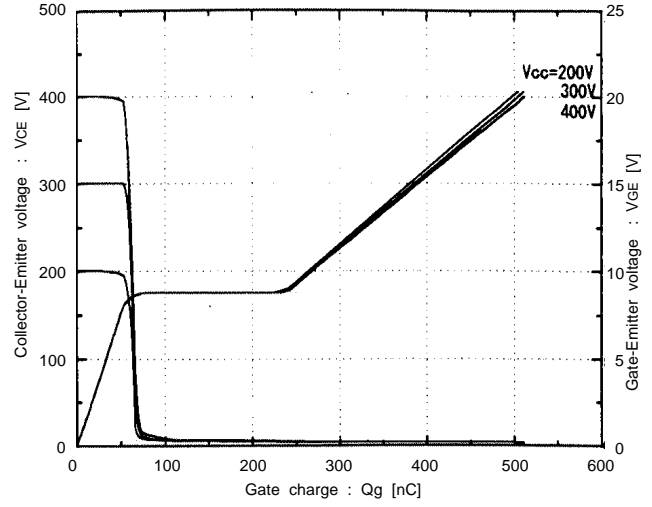

Forward current vs. Forward voltage
VGE=0V

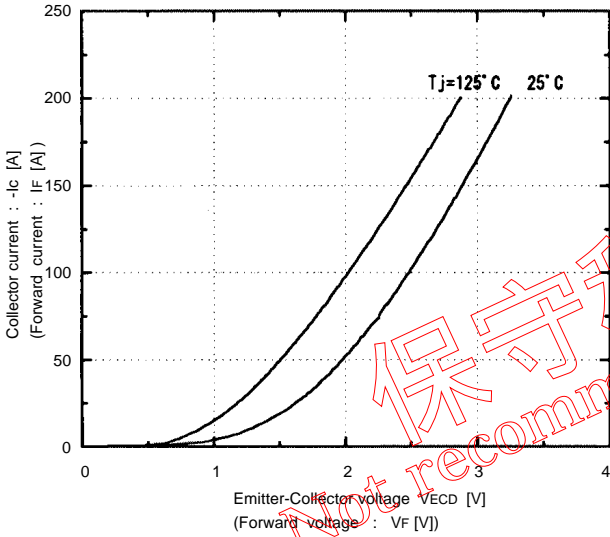

Reverse recovery characteristics
trr, Irr, vs. IF

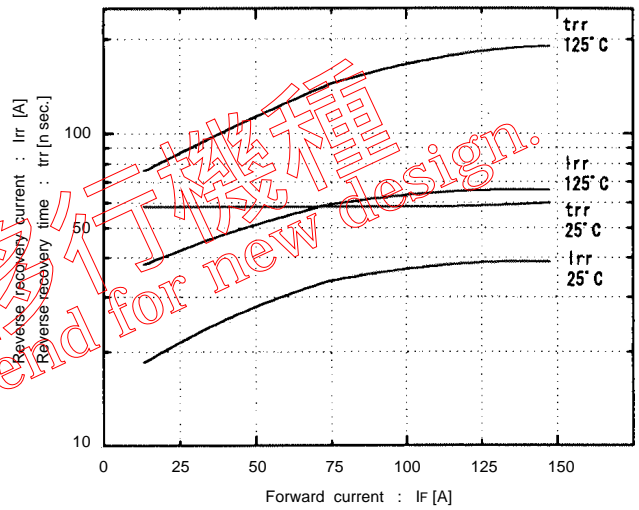

Switching loss vs. Collector current
Vcc=300V, RG=24 ohm, VGE=±15V

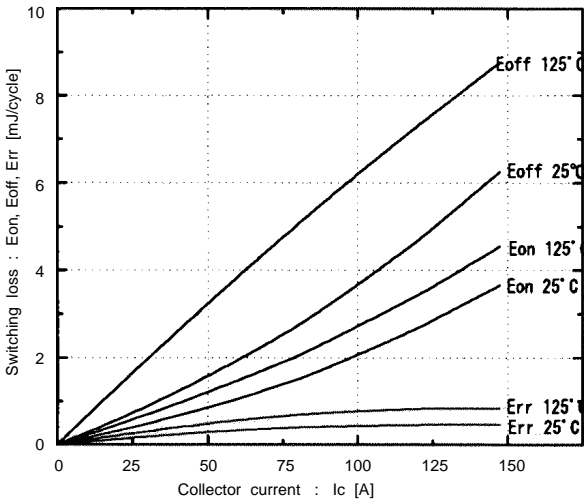

Reversed biased safe operating area
+VGE=15V, -VGE ≤ 15V, Tj ≤ 125°C, RG ≥ 24 ohm

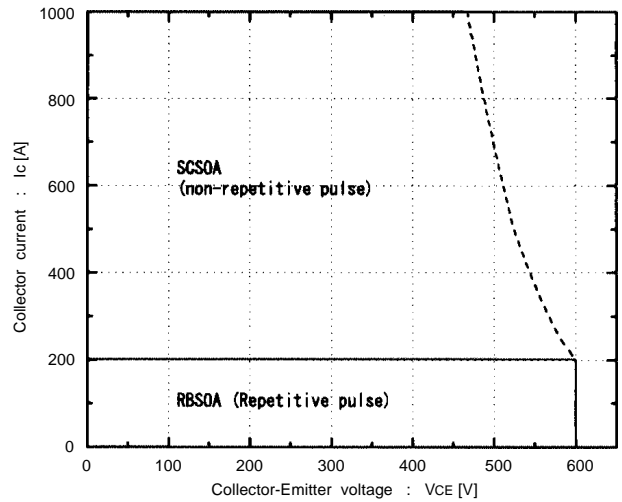

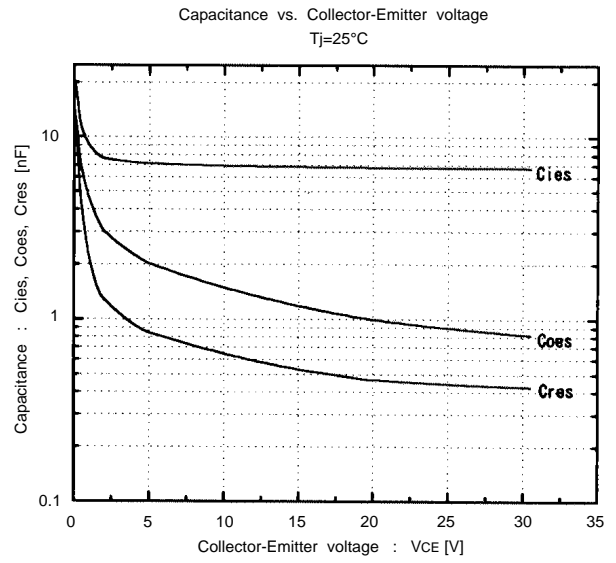
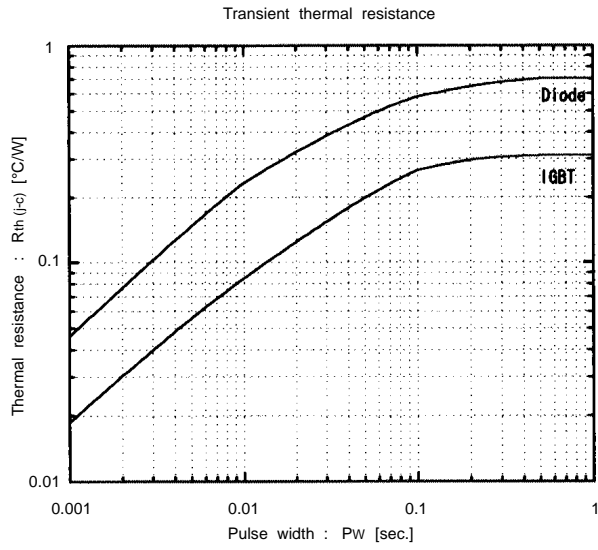

■ Outline Drawings, mm

