

2MBI100SC-120

IGBT Module

1200V / 100A 2 in one-package

■ Features

- High speed switching
- Voltage drive
- Low inductance module structure

■ Applications

- Inverter for Motor drive
- AC and DC Servo drive amplifier
- Uninterruptible power supply
- Industrial machines, such as Welding machines

■ Maximum ratings and characteristics

● Absolute maximum ratings (at Tc=25°C unless otherwise specified)

Item	Symbol	Rating	Unit	
Collector-Emitter voltage	V _{CEs}	1200	V	
Gate-Emitter voltage	V _{GES}	±20	V	
Collector current	Continuous	T _c =25°C	150	A
		T _c =80°C	100	A
	1ms	T _c =25°C	300	A
		T _c =80°C	200	A
	1ms	-I _c	100	A
	-I _c pulse	200	A	
Max. power dissipation	P _C	780	W	
Operating temperature	T _j	+150	°C	
Storage temperature	T _{stg}	-40 to +125	°C	
Isolation voltage *1	V _{is}	AC 2500 (1min.)	V	
Screw torque	Mounting *2	3.5	N·m	
	Terminals *2	3.5	N·m	

*1 : All terminals should be connected together when isolation test will be done

*2 : Recommendable value : 2.5 to 3.5 N·m(M5)

● Electrical characteristics (at T_j=25°C unless otherwise specified)

Item	Symbol	Characteristics			Conditions	Unit
		Min.	Typ.	Max.		
Zero gate voltage collector current	I _{CEs}	–	–	2.0	V _{GE} =0V, V _{CE} =1200V	mA
Gate-Emitter leakage current	I _{GES}	–	–	0.4	V _{CE} =0V, V _{GE} =±20V	μA
Gate-Emitter threshold voltage	V _{GE(th)}	5.5	7.2	8.5	V _{CE} =20V, I _c =100mA	V
Collector-Emitter saturation voltage	V _{CE(sat)}	–	2.3	2.6	T _c =25°C, V _{GE} =15V, I _c =100A	V
		–	2.8	–	T _c =125°C	
Input capacitance	C _{ies}	–	12000	–	V _{GE} =0V	pF
Output capacitance	C _{oes}	–	2500	–	V _{CE} =10V	
Reverse transfer capacitance	C _{res}	–	2200	–	f=1MHz	
Turn-on time	t _{on}	–	0.35	1.2	V _{CC} =600V	μs
	t _r	–	0.25	0.6	I _c =100A	
	t _{r(i)}	–	0.1	–	V _{GE} =±15V	
Turn-off time	t _{off}	–	0.45	1.0	R _G =9.1 ohm	μs
	t _f	–	0.08	0.3		
Forward on voltage	V _F	–	2.3	3.0	T _j =25°C, I _F =100A, V _{GE} =0V	V
		–	2.0	–	T _j =125°C	
Reverse recovery time	t _{rr}	–	–	0.35	I _F =100A	μs

● Thermal resistance characteristics

Item	Symbol	Characteristics			Conditions	Unit
		Min.	Typ.	Max.		
Thermal resistance	R _{th(j-c)}	–	–	0.16	IGBT	°C/W
	R _{th(j-c)}	–	–	0.33	Diode	°C/W
	R _{th(c-f)*2}	–	0.05	–	the base to cooling fin	°C/W

*2 : This is the value which is defined mounting on the additional cooling fin with thermal compound



Equivalent Circuit Schematic

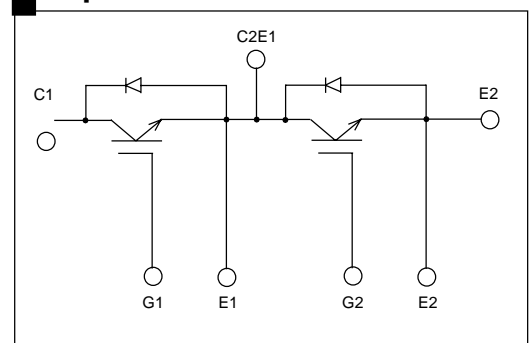

Characteristics (Representative)

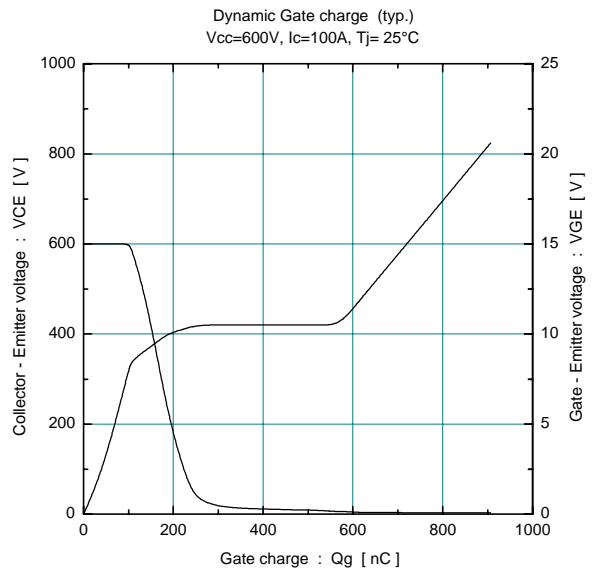
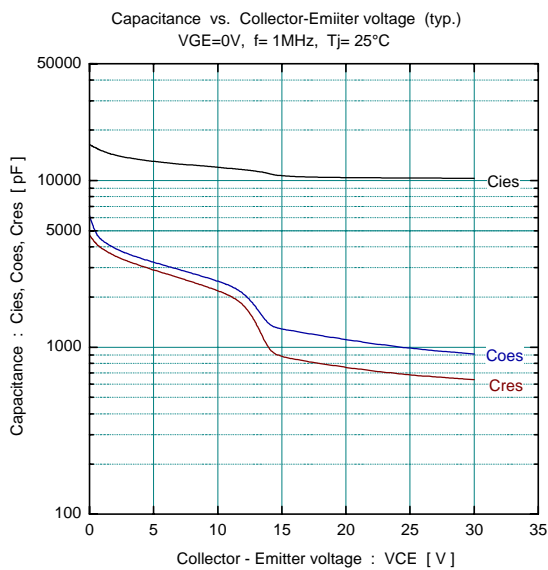
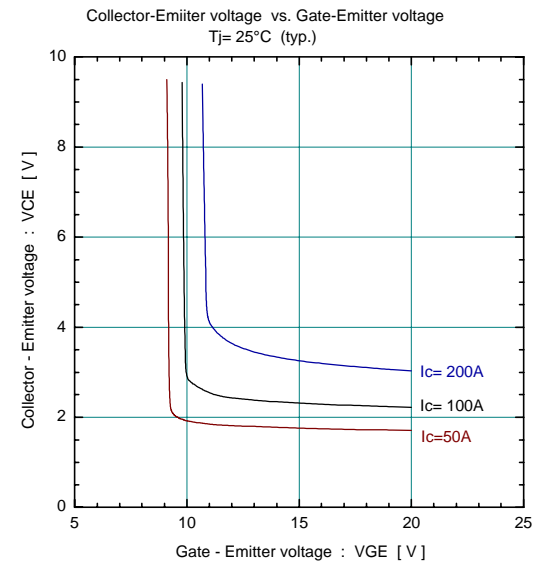
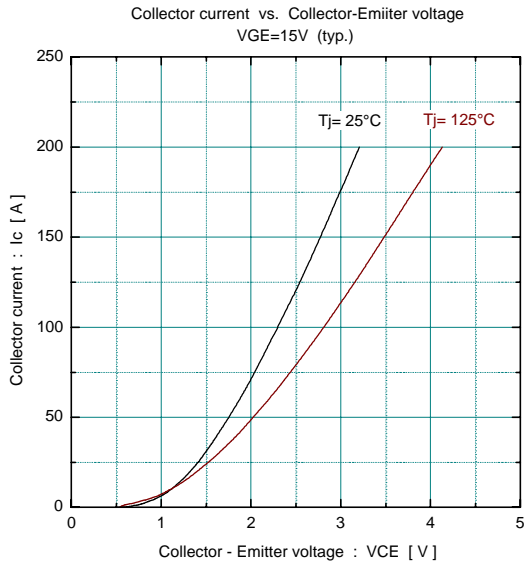
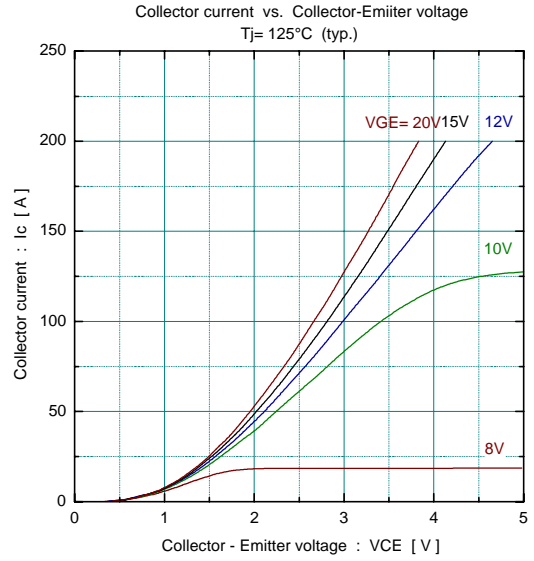
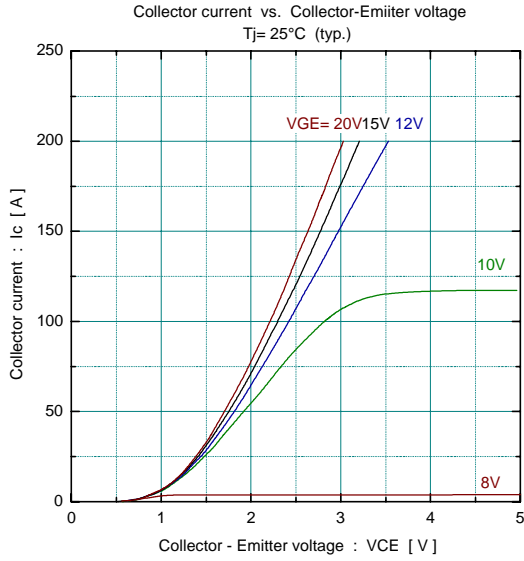

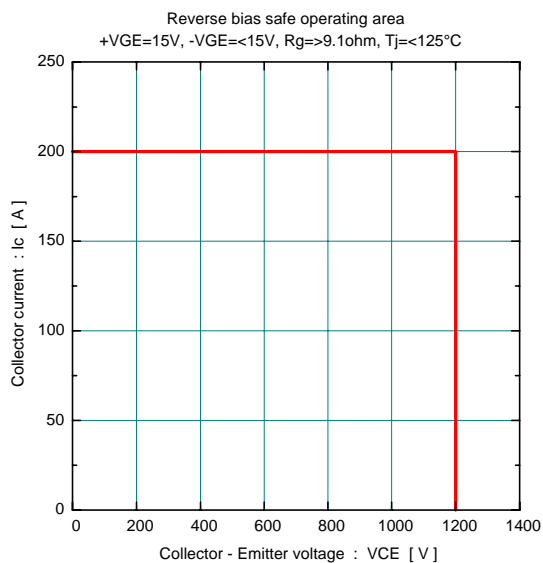
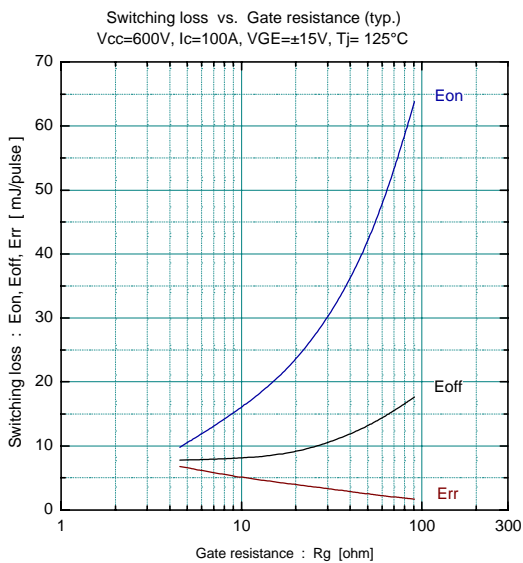
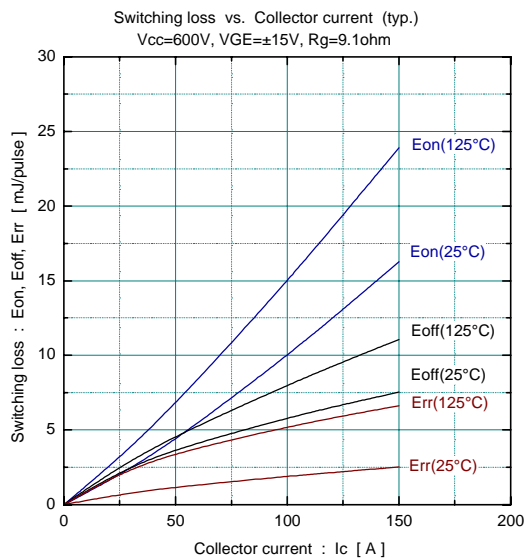
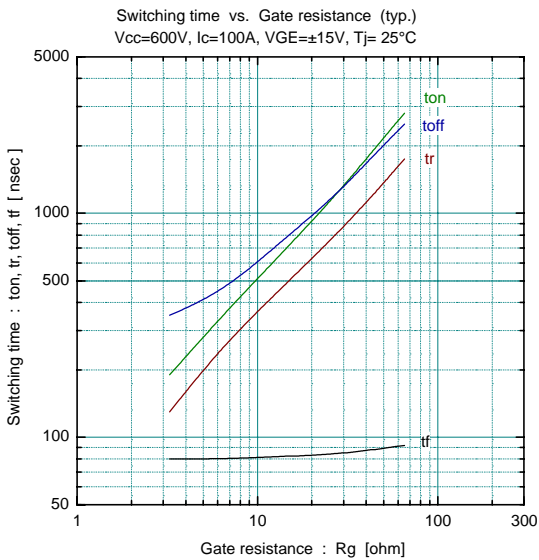
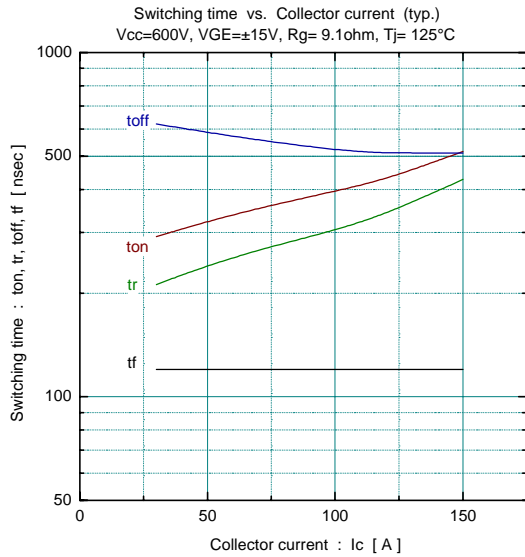
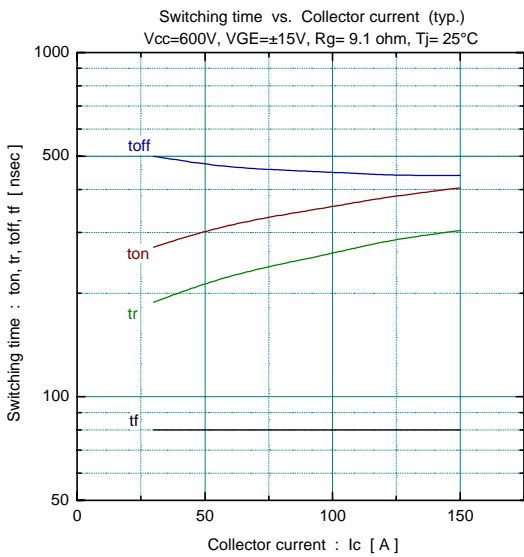

Forward current vs. Forward on voltage (typ.)

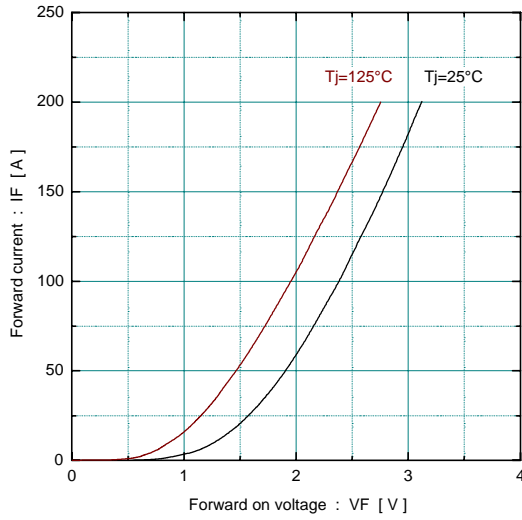

Reverse recovery characteristics (typ.)
Vcc=600V, VGE=±15V, Rg=9.1ohm

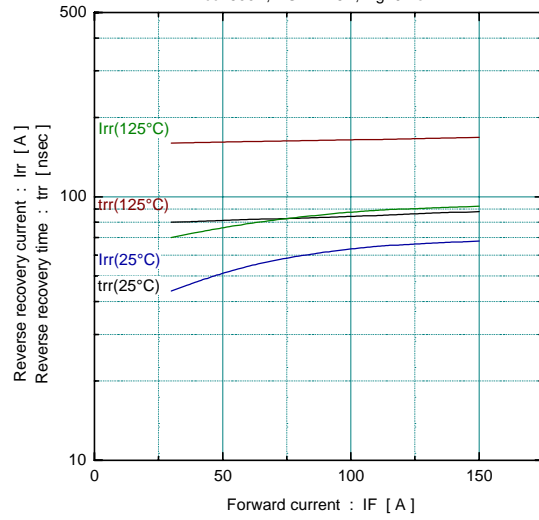

Transient thermal resistance

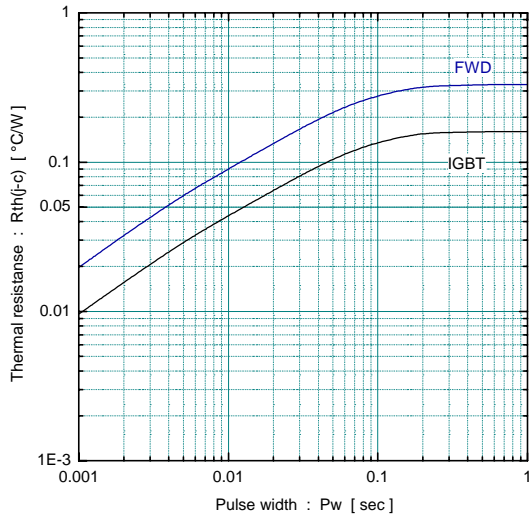

■ Outline Drawings, mm

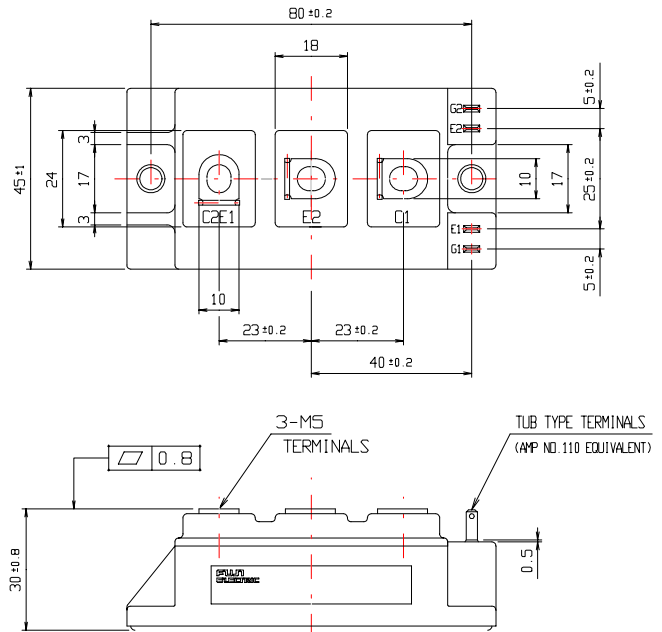

mass : 240g