

# 2MBI150SC-120

IGBT Module

## 1200V / 150A 2 in one-package

### ■ Features

- High speed switching
- Voltage drive
- Low inductance module structure

### ■ Applications

- Inverter for Motor drive
- AC and DC Servo drive amplifier
- Uninterruptible power supply
- Industrial machines, such as Welding machines

### ■ Maximum ratings and characteristics

#### ● Absolute maximum ratings (at Tc=25°C unless otherwise specified)

Item	Symbol	Rating	Unit	
Collector-Emitter voltage	V <sub>CEs</sub>	1200	V	
Gate-Emitter voltage	V <sub>GES</sub>	±20	V	
Collector current	Continuous	T <sub>c</sub> =25°C	200	A
		T <sub>c</sub> =80°C	150	A
	1ms	T <sub>c</sub> =25°C	400	A
		T <sub>c</sub> =80°C	300	A
	1ms	-I <sub>c</sub>	150	A
	-I <sub>c</sub> pulse	300	A	
Max. power dissipation	P <sub>c</sub>	1000	W	
Operating temperature	T <sub>j</sub>	+150	°C	
Storage temperature	T <sub>stg</sub>	-40 to +125	°C	
Isolation voltage *1	V <sub>is</sub>	AC 2500 (1min.)	V	
Screw torque	Mounting *2	3.5	N·m	
	Terminals *2	3.5	N·m	

\*1 : All terminals should be connected together when isolation test will be done

\*2 : Recommendable value : 2.5 to 3.5 N·m(M5)

#### ● Electrical characteristics (at Tj=25°C unless otherwise specified)

Item	Symbol	Characteristics			Conditions	Unit
		Min.	Typ.	Max.		
Zero gate voltage collector current	I <sub>CEs</sub>	–	–	2.0	V <sub>GE</sub> =0V, V <sub>CE</sub> =1200V	mA
Gate-Emitter leakage current	I <sub>GES</sub>	–	–	0.4	V <sub>CE</sub> =0V, V <sub>GE</sub> =±20V	μA
Gate-Emitter threshold voltage	V <sub>GE(th)</sub>	5.5	7.2	8.5	V <sub>CE</sub> =20V, I <sub>c</sub> =150mA	V
Collector-Emitter saturation voltage	V <sub>CE(sat)</sub>	–	2.3	2.6	T <sub>c</sub> =25°C, V <sub>GE</sub> =15V, I <sub>c</sub> =150A	V
		–	2.8	–	T <sub>c</sub> =125°C	
Input capacitance	C <sub>ies</sub>	–	18000	–	V <sub>GE</sub> =0V	pF
Output capacitance	C <sub>oes</sub>	–	3750	–	V <sub>CE</sub> =10V	
Reverse transfer capacitance	C <sub>res</sub>	–	3300	–	f=1MHz	
Turn-on time	t <sub>on</sub>	–	0.35	1.2	V <sub>CC</sub> =600V	μs
	t <sub>r</sub>	–	0.25	0.6	I <sub>c</sub> =150A	
	t <sub>r(i)</sub>	–	0.1	–	V <sub>GE</sub> =±15V	
Turn-off time	t <sub>off</sub>	–	0.45	1.0	R <sub>G</sub> =5.6 ohm	μs
	t <sub>f</sub>	–	0.08	0.3		
Forward on voltage	V <sub>F</sub>	–	2.3	3.0	T <sub>j</sub> =25°C, I <sub>F</sub> =150A, V <sub>GE</sub> =0V	V
		–	2.0	–	T <sub>j</sub> =125°C	
Reverse recovery time	t <sub>rr</sub>	–	–	0.35	I <sub>F</sub> =150A	μs

#### ● Thermal resistance characteristics

Item	Symbol	Characteristics			Conditions	Unit
		Min.	Typ.	Max.		
Thermal resistance	R <sub>th(j-c)</sub>	–	–	0.125	IGBT	°C/W
	R <sub>th(j-c)</sub>	–	–	0.26	Diode	°C/W
	R <sub>th(c-f)*2</sub>	–	0.025	–	the base to cooling fin	°C/W

\*2 : This is the value which is defined mounting on the additional cooling fin with thermal compound



### ■ Equivalent Circuit Schematic

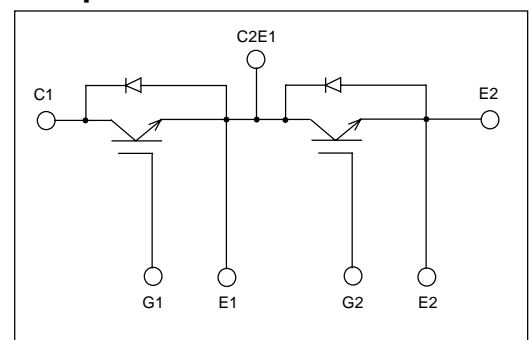

Characteristics (Representative)

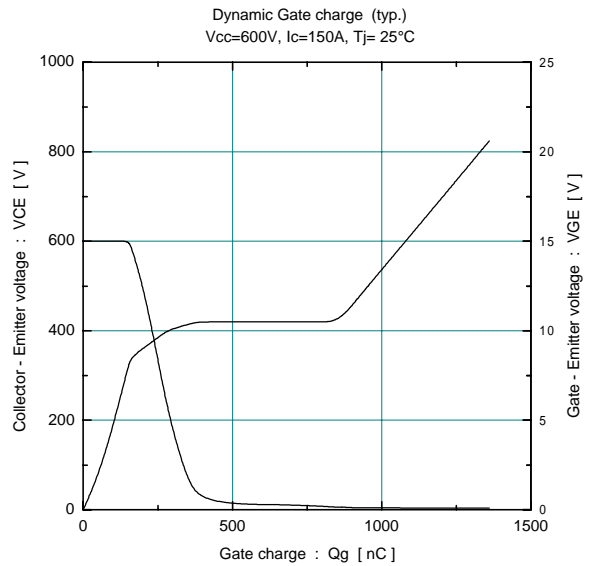
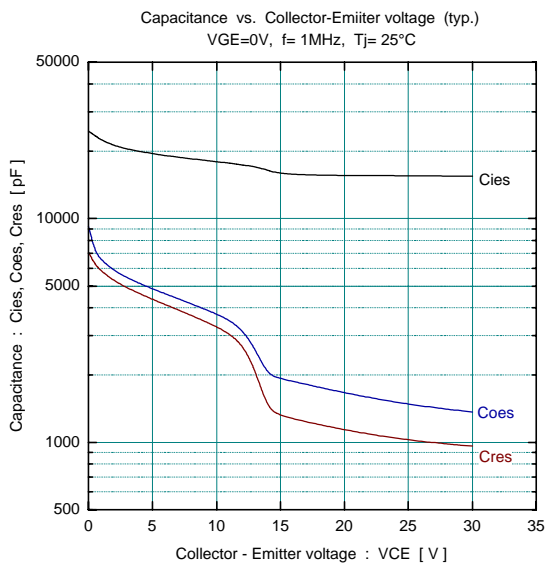
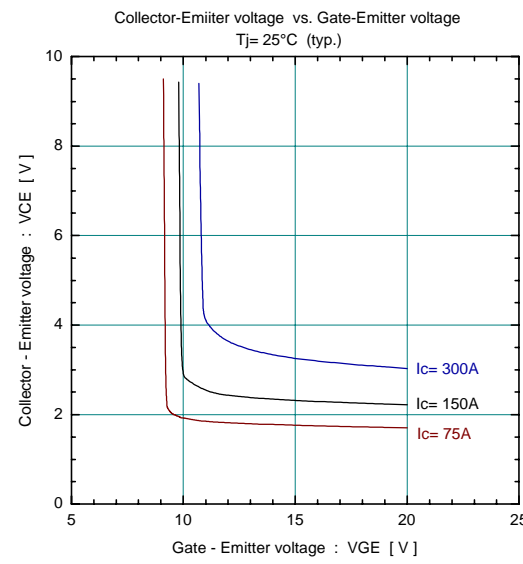
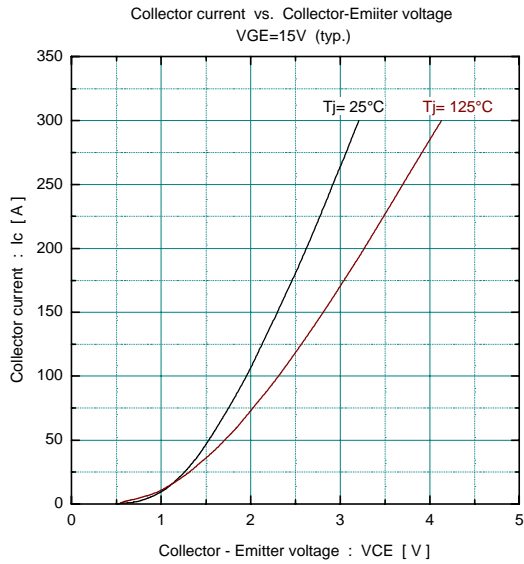
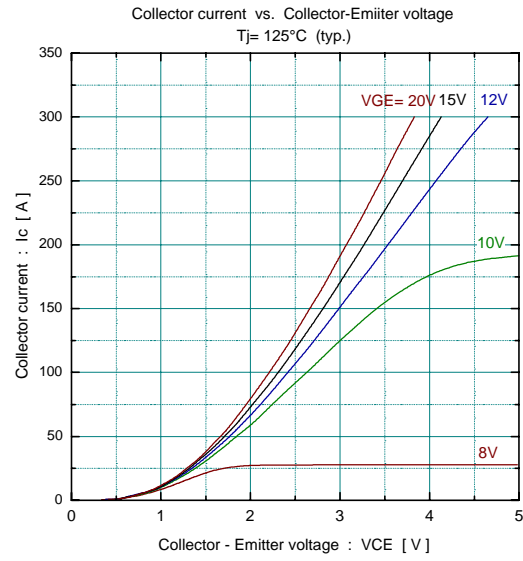
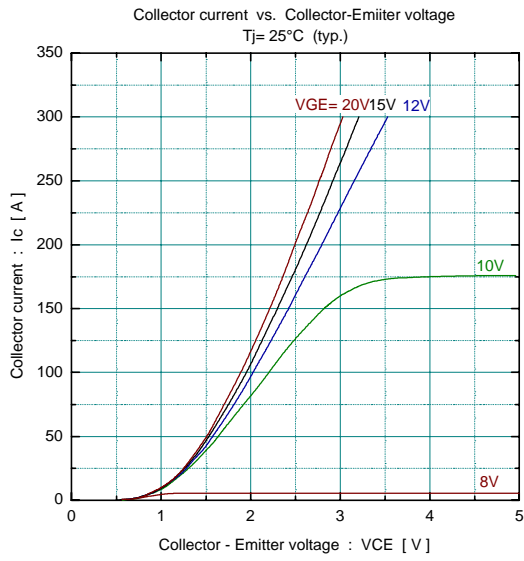

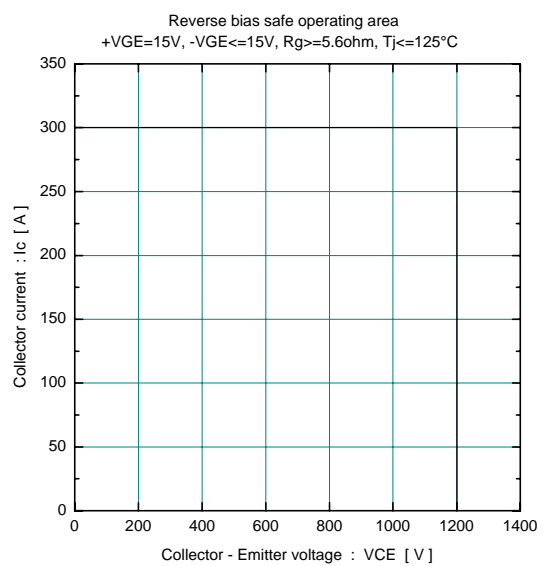
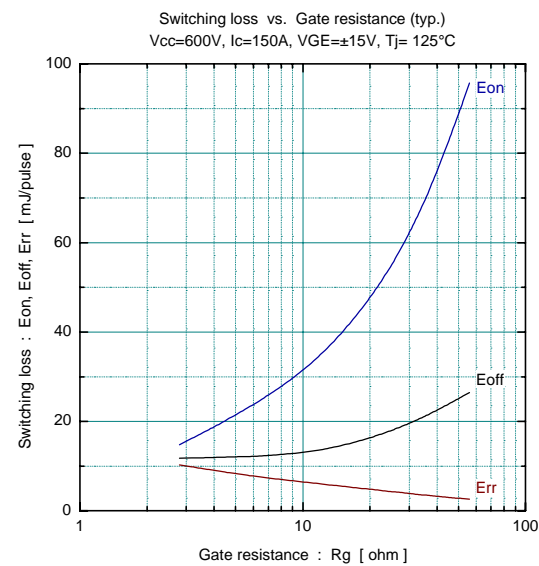
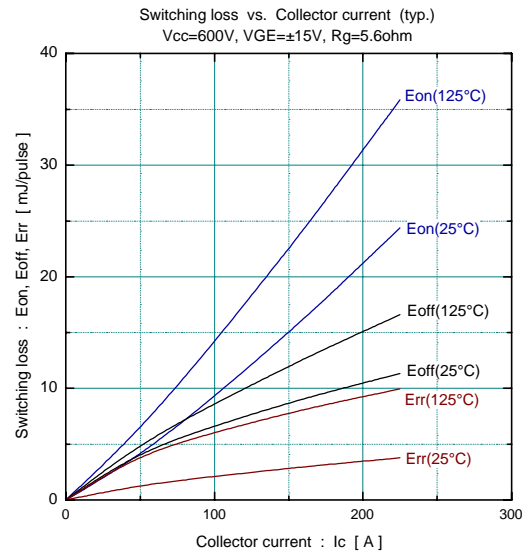
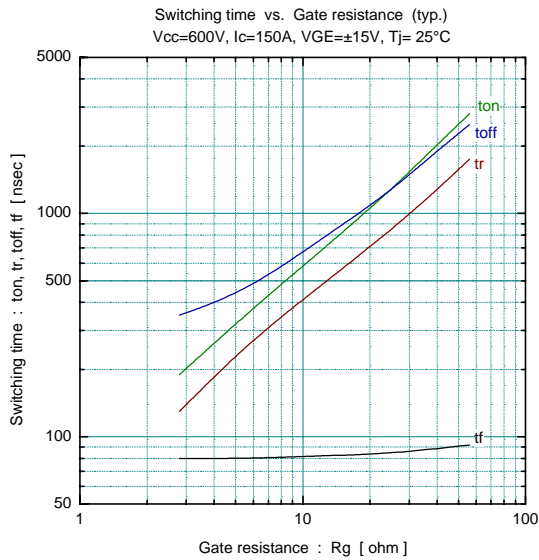
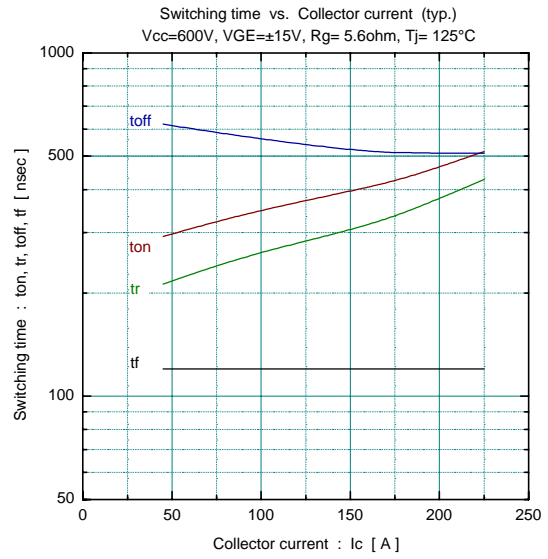
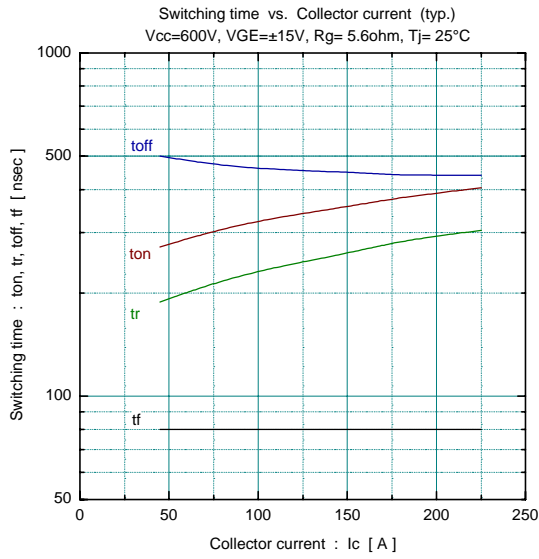

Forward current vs. Forward on voltage (typ.)

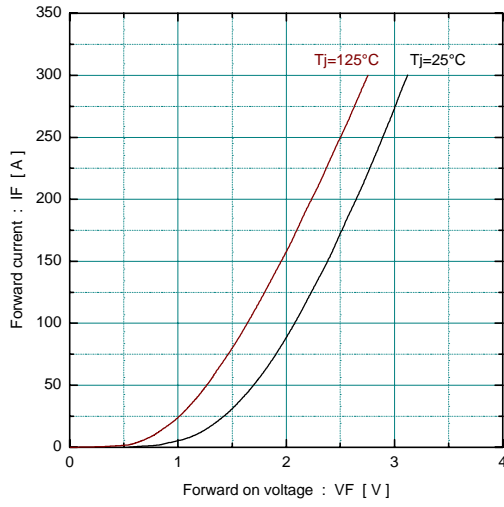

Reverse recovery characteristics (typ.)

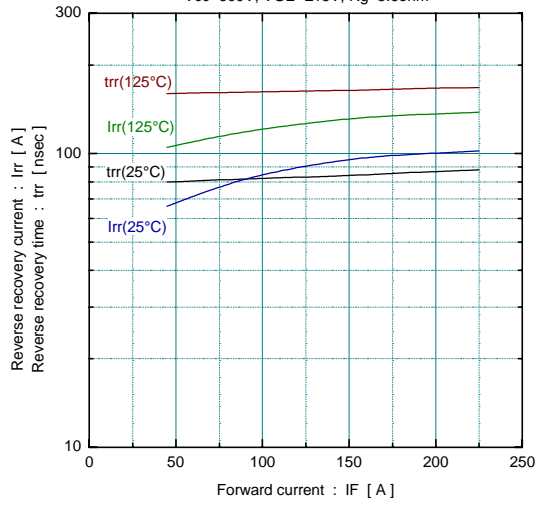

Transient thermal resistance

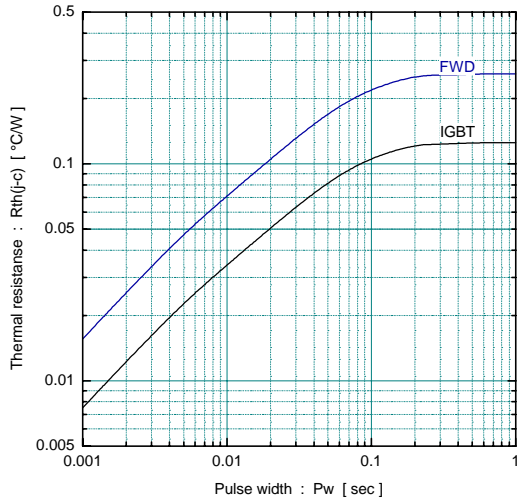

■ Outline Drawings, mm

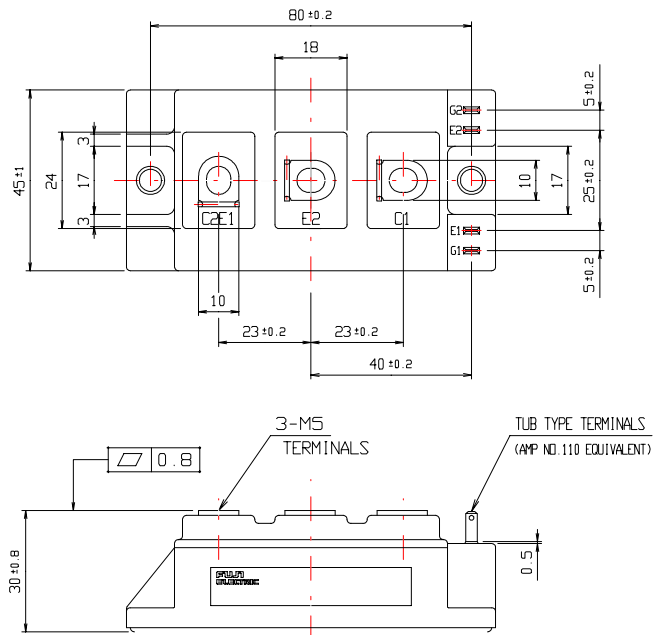

mass : 240g