

$V_{RSM}$	=	5200 V
$I_{FAVM}$	=	1028 A
$I_{FRMS}$	=	1614 A
$I_{FSM}$	=	$12.8 \times 10^3$ A
$V_{F0}$	=	0.894 V
$r_F$	=	0.487 m $\Omega$

# Rectifier Diode

## 5SDD 08D5000

Doc. No. 5SYA1165-00 Jan. 03

- Very low on-state losses
- Optimum power handling capability

### Blocking

*Maximum rated values <sup>1)</sup>*

Parameter	Symbol	Conditions	Value	Unit
Repetitive peak reverse voltage	$V_{RRM}$	$f = 50$ Hz, $t_p = 10$ ms, $T_j = -40 \dots 160^\circ\text{C}$	5000	V
Non - repetitive peak reverse voltage	$V_{RSM}$	$f = 5$ Hz, $t_p = 10$ ms, $T_j = -40 \dots 160^\circ\text{C}$	5200	V

*Characteristic values*

Parameter	Symbol	Conditions	min	typ	max	Unit
Max. (reverse) leakage current	$I_{RRM}$	$V_{RRM}$ , $T_j = 160^\circ\text{C}$			30	mA

### Mechanical data

*Maximum rated values <sup>1)</sup>*

Parameter	Symbol	Conditions	min	typ	max	Unit
Mounting force	$F_M$		8	10	12	kN
Acceleration	a	Device unclamped			50	m/s <sup>2</sup>
Acceleration	a	Device clamped			100	m/s <sup>2</sup>

*Characteristic values*

Parameter	Symbol	Conditions	min	typ	max	Unit
Weight	m			0.3		kg
Housing thickness	H			26		mm
Pole-piece diameter	$D_P$			34		mm
Surface creepage distance	$D_S$		30			mm
Air strike distance	$D_a$		18			mm

1) Maximum rated values indicate limits beyond which damage to the device may occur

ABB Switzerland Ltd, Semiconductors reserves the right to change specifications without notice.



## On-state

Maximum rated values <sup>1)</sup>

Parameter	Symbol	Conditions	min	typ	max	Unit
Max. average on-state current	I <sub>FAVM</sub>	50 Hz, Half sine wave, T <sub>C</sub> = 85 °C			1028	A
Max. RMS on-state current	I <sub>FRMS</sub>				1614	A
Max. peak non-repetitive surge current	I <sub>FSM</sub>	t <sub>p</sub> = 10 ms, T <sub>j</sub> = 160°C, V <sub>R</sub> = 0 V			12.8×10 <sup>3</sup>	A
Limiting load integral	I <sup>2</sup> t				682×10 <sup>3</sup>	A <sup>2</sup> s
Max. peak non-repetitive surge current	I <sub>FSM</sub>	t <sub>p</sub> = 8.3 ms, T <sub>j</sub> = 160°C, V <sub>R</sub> = 0 V			12×10 <sup>3</sup>	A
Limiting load integral	I <sup>2</sup> t				720×10 <sup>3</sup>	A <sup>2</sup> s

Characteristic values

Parameter	Symbol	Conditions	min	typ	max	Unit
On-state voltage	V <sub>F</sub>	I <sub>F</sub> = 1500 A, T <sub>j</sub> = 160°C			1.65	V
Threshold voltage	V <sub>(T0)</sub>	T <sub>j</sub> = 160°C			0.894	V
Slope resistance	r <sub>T</sub>	I <sub>T</sub> = 1500...4500 A			0.487	mΩ

## Switching

Characteristic values

Parameter	Symbol	Conditions	min	typ	max	Unit
Recovery charge	Q <sub>rr</sub>	di <sub>F</sub> /dt = -30 A/μs, V <sub>R</sub> = 100 V I <sub>FRM</sub> = 1000 A, T <sub>j</sub> = 160°C		2400	3500	μAs

## Thermal

Maximum rated values <sup>1)</sup>

Parameter	Symbol	Conditions	min	typ	max	Unit
Operating junction temperature range	T <sub>vj</sub>		-40		160	°C
Storage temperature range	T <sub>stg</sub>		-40		160	°C

Characteristic values

Parameter	Symbol	Conditions	min	typ	max	Unit
Thermal resistance junction to case	R <sub>th(j-c)</sub>	Double-side cooled			32	K/kW
	R <sub>th(j-c)A</sub>	Anode-side cooled			50	K/kW
	R <sub>th(j-c)C</sub>	Cathode-side cooled			88	K/kW
Thermal resistance case to heatsink	R <sub>th(c-h)</sub>	Double-side cooled			8	K/kW
	R <sub>th(c-h)</sub>	Single-side cooled			16	K/kW

Analytical function for transient thermal impedance:

$$Z_{thJC}(t) = \sum_{i=1}^n R_i(1 - e^{-t/\tau_i})$$

i	1	2	3	4
R <sub>i</sub> (K/kW)	11.600	10.110	7.870	2.410
τ <sub>i</sub> (s)	0.7033	0.2185	0.0588	0.0042

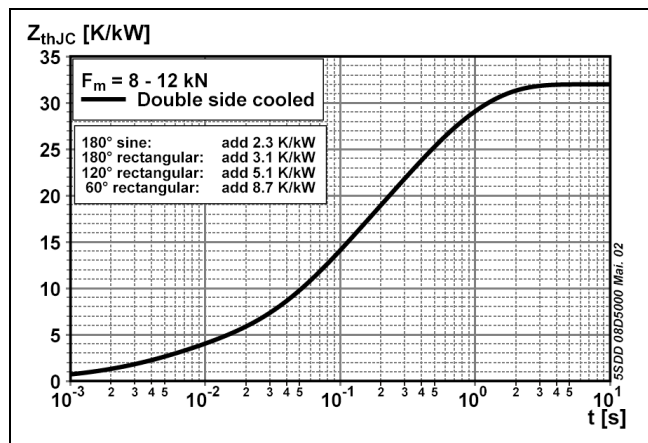

Fig. 1 Transient thermal impedance junction-to-case.

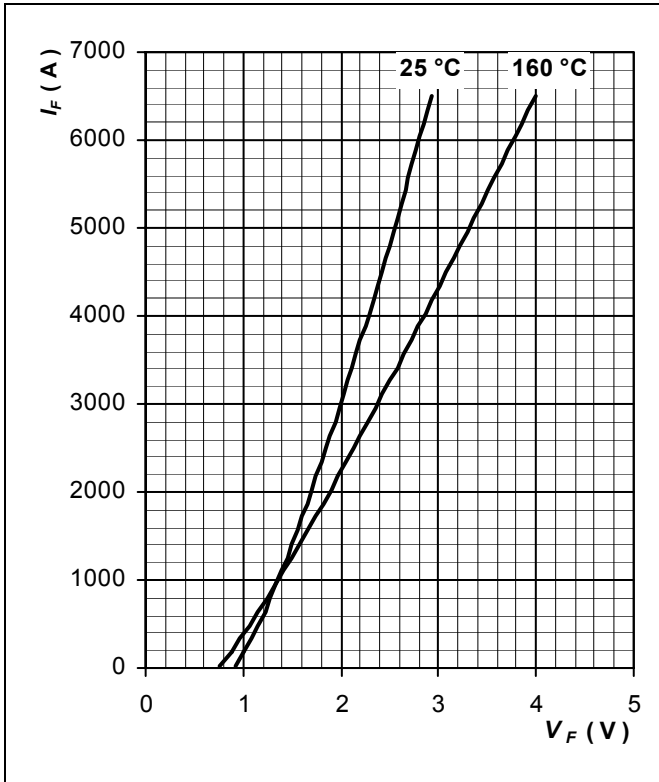

Fig. 2 Max. on-state characteristics.

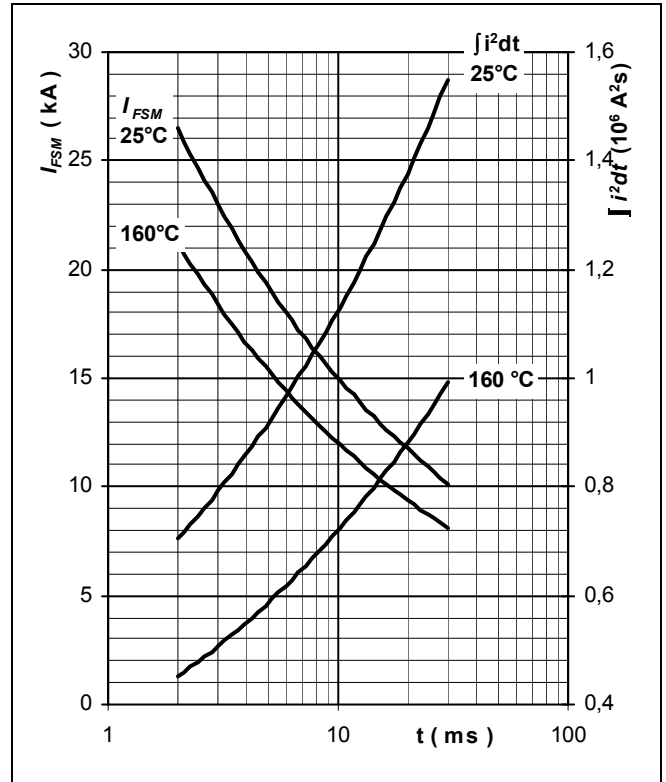

Fig. 3 Surge forward current vs. pulse length. Half sine wave, single pulse,  $V_R = 0$  V

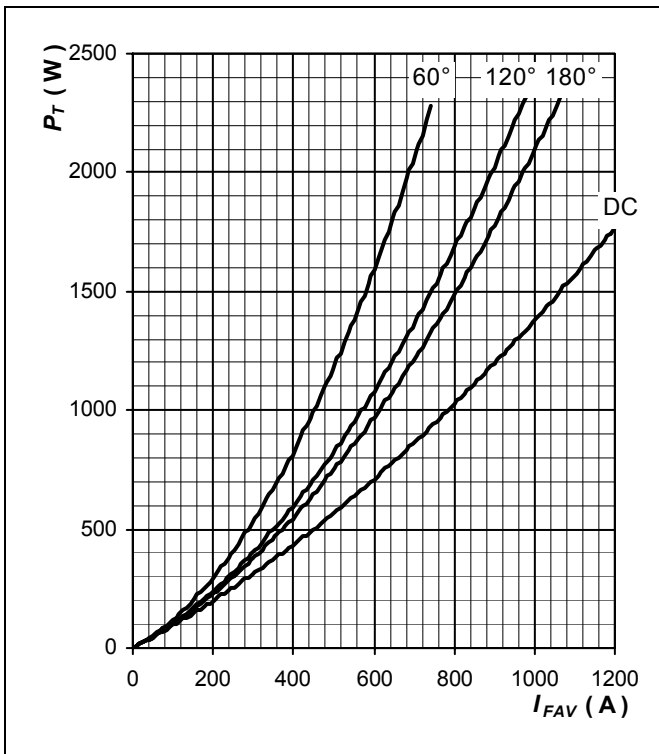

Fig. 4 Forward power loss vs. average forward current, sine waveform,  $f = 50$  Hz

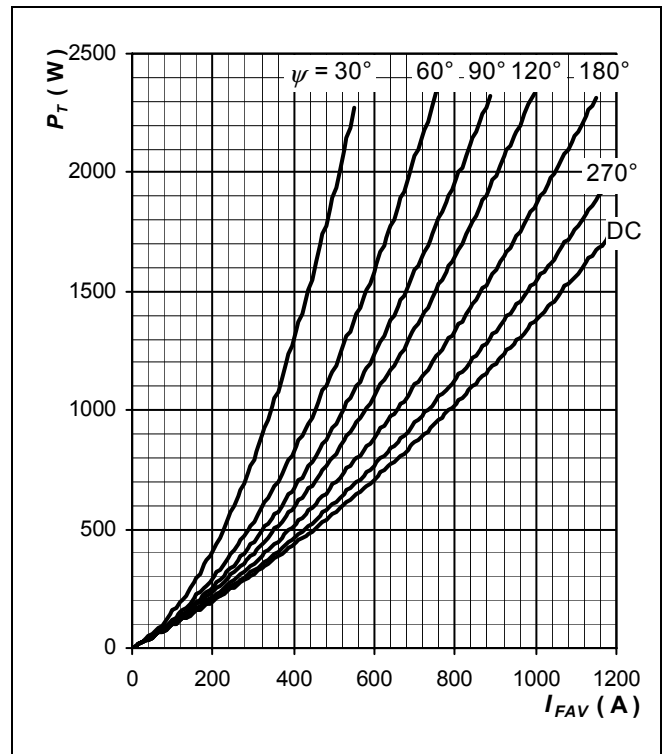
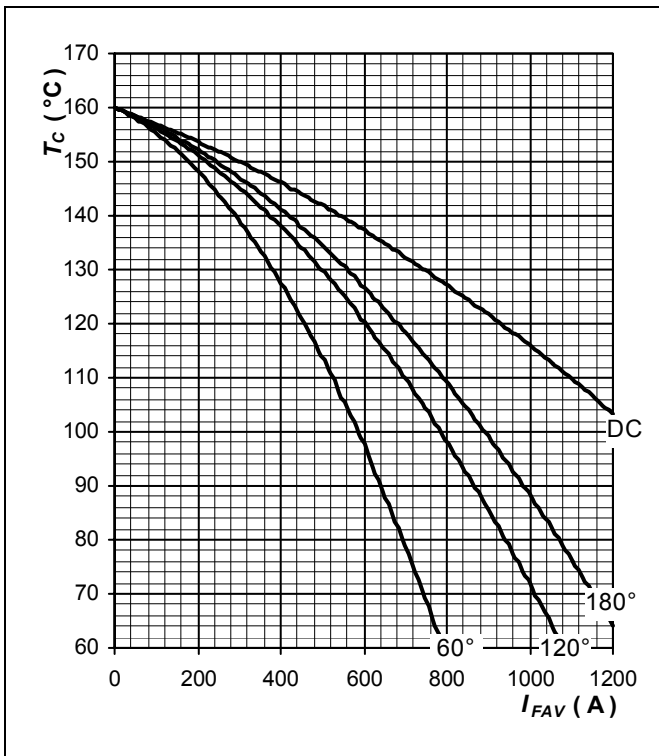
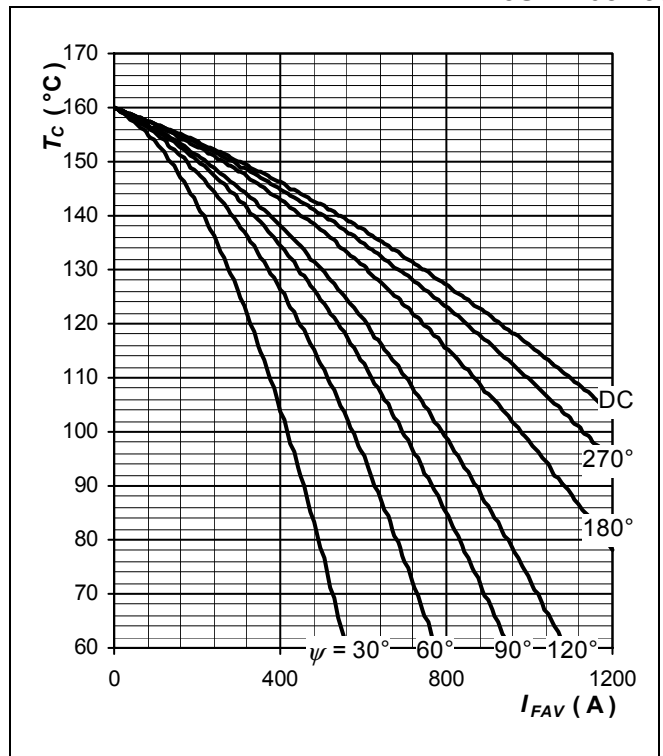

Fig. 5 Forward power loss vs. average forward current, square waveform,  $f = 50$  Hz



**Fig. 6** Max. case temperature vs aver. forward current, sine waveform,  $f = 50$  Hz



**Fig. 7** Max. case temperature vs aver. forward current, square waveform,  $f = 50$  Hz

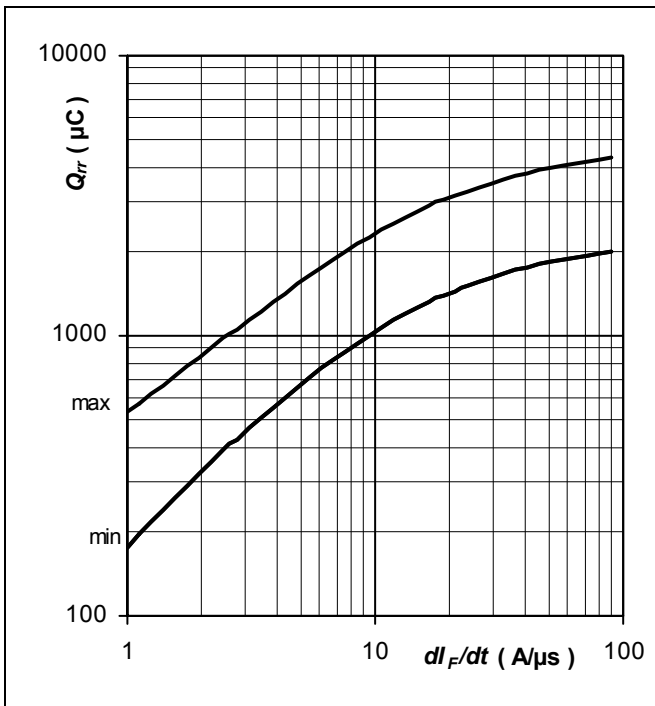

**Fig. 8** Reverse recovery charge vs.  $di_F/dt$ ,  $I_F = 1000$  A;  $T_J = T_{Jmax}$ , limit values

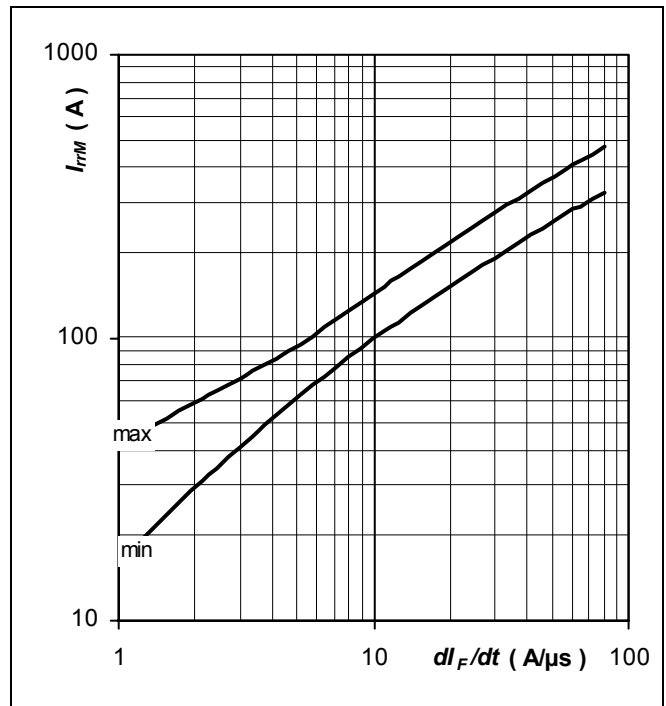

**Fig. 9** Peak reverse recovery current vs.  $di_F/dt$ ,  $I_F = 1000$  A;  $T_J = T_{Jmax}$ , limit values

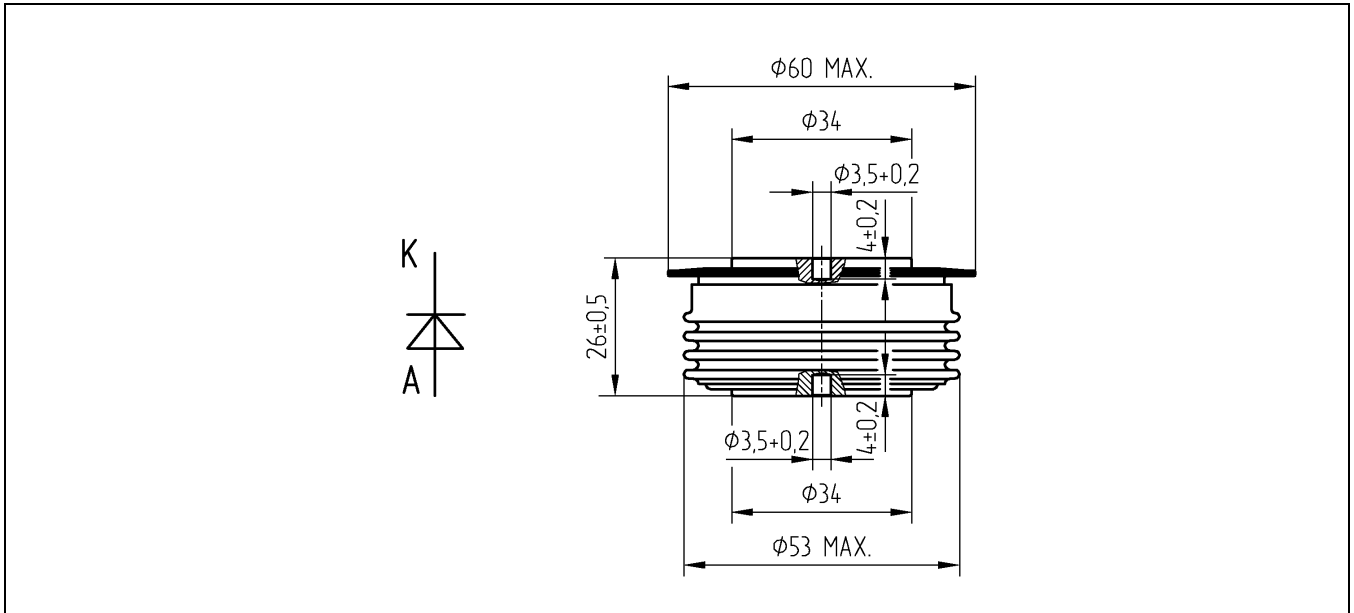

**Fig. 10** Outline drawing. All dimensions are in millimeters and represent nominal values unless stated otherwise.

ABB Switzerland Ltd, Semiconductors reserves the right to change specifications without notice.

# ABB

**ABB Switzerland Ltd**  
**Semiconductors**  
 Fabrikstrasse 3  
 CH-5600 Lenzburg, Switzerland

Doc. No. 5SYA1165-00 Jan. 03

Telephone +41 (0)58 586 1419  
 Fax +41 (0)58 586 1306  
 Email [abbsem@ch.abb.com](mailto:abbsem@ch.abb.com)  
 Internet [www.abb.com/semiconductors](http://www.abb.com/semiconductors)