

V_{RSM}	=	5500 V
$I_{F(AV)M}$	=	3480 A
$I_{F(RMS)}$	=	5470 A
I_{FSM}	=	46×10^3 A
V_{F0}	=	0.94 V
r_F	=	0.147 mW

Rectifier Diode

5SDD 33L5500

Doc. No. 5SYA1168-00 March 05

- Patented free-floating silicon technology
- Very low on-state losses
- Optimum power handling capability

Blocking

*Maximum rated values*¹⁾

Parameter	Symbol	Conditions	Value	Unit
Repetitive peak reverse voltage	V_{RRM}	$f = 50$ Hz, $t_p = 10$ ms, $T_j = 0 \dots 150^\circ\text{C}$	5000	V
Non-repetitive peak reverse voltage	V_{RSM}	$f = 5$ Hz, $t_p = 10$ ms, $T_j = 0 \dots 150^\circ\text{C}$	5500	V

Characteristic values

Parameter	Symbol	Conditions	min	typ	max	Unit
Max. (reverse) leakage current	I_{RRM}	V_{RRM} , $T_j = 150^\circ\text{C}$			400	mA

Mechanical data

*Maximum rated values*¹⁾

Parameter	Symbol	Conditions	min	typ	max	Unit
Mounting force	F_M		63	70	77	kN
Acceleration	a	Device unclamped			50	m/s^2
Acceleration	a	Device clamped			100	m/s^2

Characteristic values

Parameter	Symbol	Conditions	min	typ	max	Unit
Weight	m				1.45	kg
Housing thickness	H	$F_M = 70$ kN, $T_a = 25^\circ\text{C}$	26.0		26.6	mm
Surface creepage distance	D_S		35			mm
Air strike distance	D_a		14			mm

1) Maximum rated values indicate limits beyond which damage to the device may occur

ABB Switzerland Ltd, Semiconductors reserves the right to change specifications without notice.



On-state

Maximum rated values ¹⁾

Parameter	Symbol	Conditions	min	typ	max	Unit
Max. average on-state current	$I_{F(AV)M}$	50 Hz, Half sine wave, $T_C = 90^\circ\text{C}$			3480	A
Max. RMS on-state current	$I_{F(RMS)}$				5470	A
Max. peak non-repetitive surge current	I_{FSM}	$t_p = 10\text{ ms}$, $T_j = 150^\circ\text{C}$, $V_R = 0\text{ V}$			46×10^3	A
Limiting load integral	I^2t				10.6×10^6	A^2s
Max. peak non-repetitive surge current	I_{FSM}	$t_p = 8.3\text{ ms}$, $T_j = 150^\circ\text{C}$, $V_R = 0\text{ V}$			49.2×10^3	A
Limiting load integral	I^2t				10.06×10^6	A^2s

Characteristic values

Parameter	Symbol	Conditions	min	typ	max	Unit
On-state voltage	V_F	$I_F = 5000\text{ A}$, $T_j = 150^\circ\text{C}$			1.68	V
Threshold voltage	$V_{(T0)}$	$T_j = 150^\circ\text{C}$			0.94	V
Slope resistance	r_T	$I_T = 3000 \dots 8000\text{ A}$			0.147	$\text{m}\Omega$

Switching

Characteristic values

Parameter	Symbol	Conditions	min	typ	max	Unit
Recovery charge	Q_{rr}	$di_F/dt = -10\text{ A}/\mu\text{s}$, $V_R = 200\text{ V}$ $I_{FRM} = 4000\text{ A}$, $T_j = 150^\circ\text{C}$			10000	μAs

Thermal

Maximum rated values ¹⁾

Parameter	Symbol	Conditions	min	typ	max	Unit
Operating junction temperature range	T_{vj}		0		150	°C
Storage temperature range	T_{stg}		-40		150	°C

Characteristic values

Parameter	Symbol	Conditions	min	typ	max	Unit
Thermal resistance junction to case	$R_{th(j-c)}$	Double-side cooled $F_m = 63...77$ kN			7	K/kW
	$R_{th(j-c)A}$	Anode-side cooled $F_m = 63...77$ kN			14	K/kW
	$R_{th(j-c)C}$	Cathode-side cooled $F_m = 63...77$ kN			14	K/kW
Thermal resistance case to heatsink	$R_{th(c-h)}$	Double-side cooled $F_m = 63...77$ kN			1.5	K/kW
	$R_{th(c-h)}$	Single-side cooled $F_m = 63...77$ kN			3	K/kW

Analytical function for transient thermal impedance:

$$Z_{th(j-c)}(t) = \sum_{i=1}^n R_{th i} (1 - e^{-t/t_i})$$

i	1	2	3	4
$R_{th i}$ (K/kW)	4.701	1.401	0.611	0.298
τ_i (s)	0.5463	0.0746	0.0087	0.0021

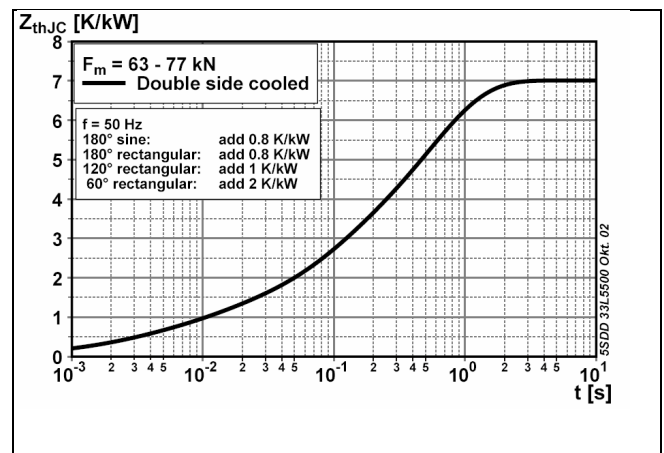

Fig. 1 Transient thermal impedance junction-to-case.

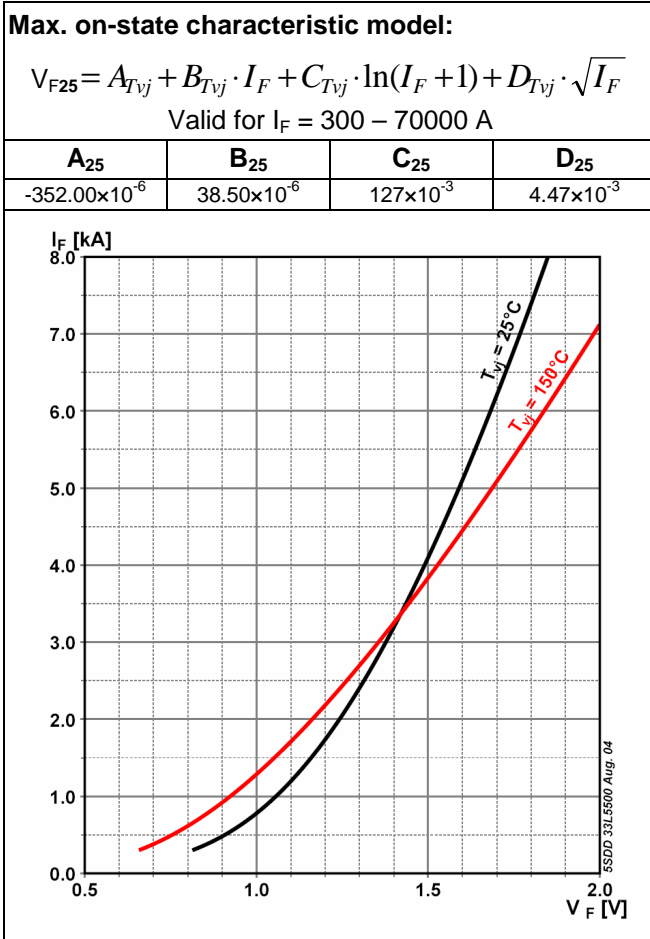

Fig. 2 Isothermal on-state characteristics

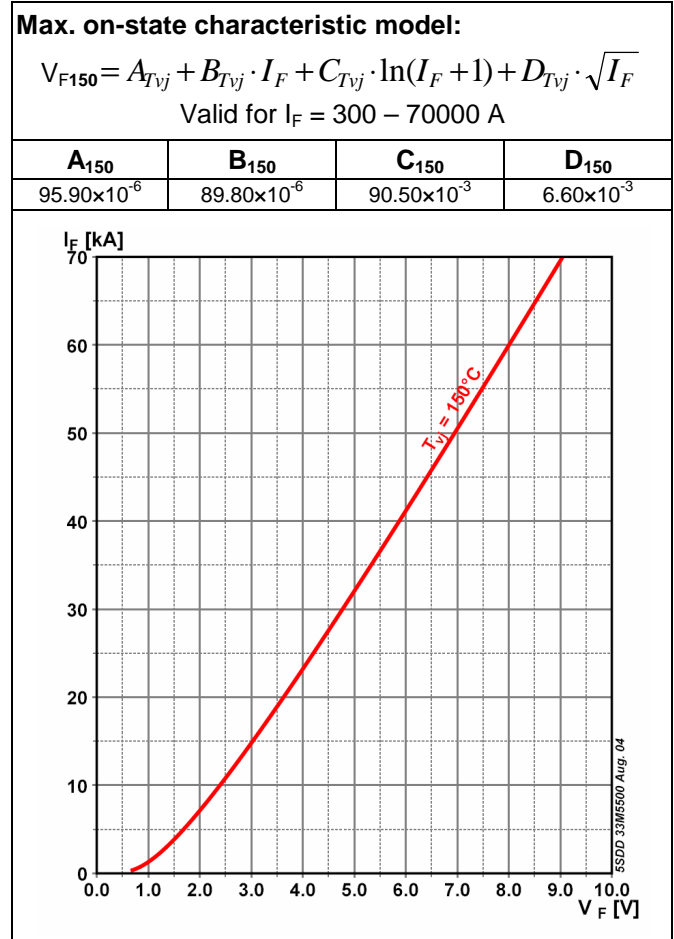

Fig. 3 Isothermal on-state characteristics

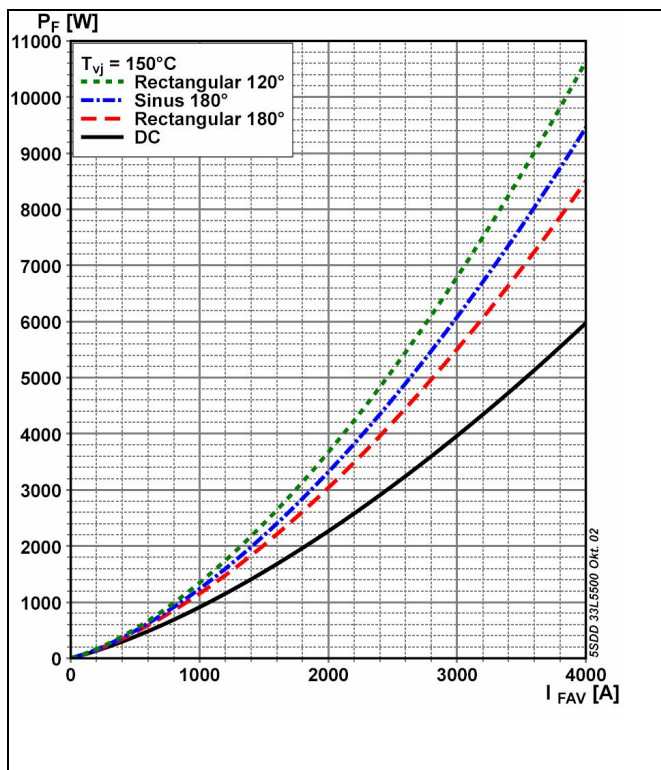

Fig. 4 On-state power losses vs average on-state current.

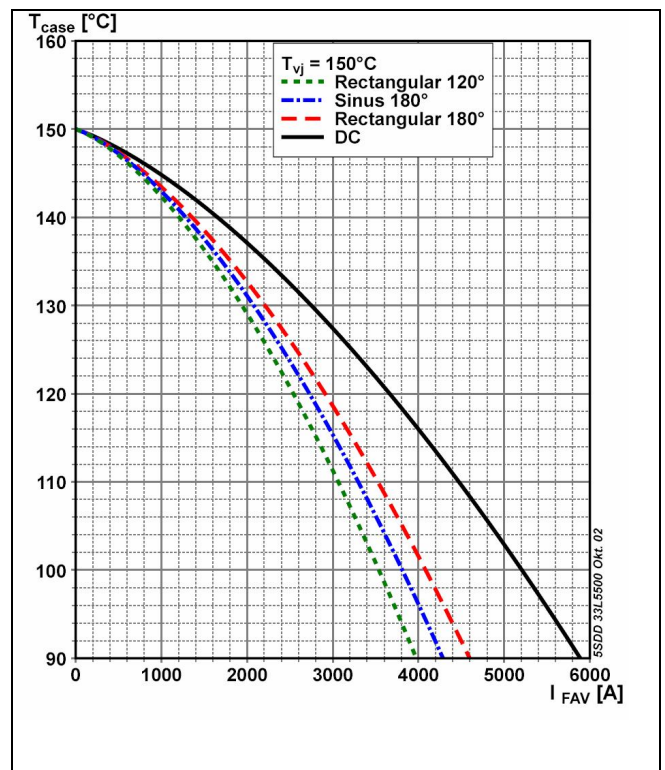

Fig. 5 Max. permissible case temperature vs average on-state current.

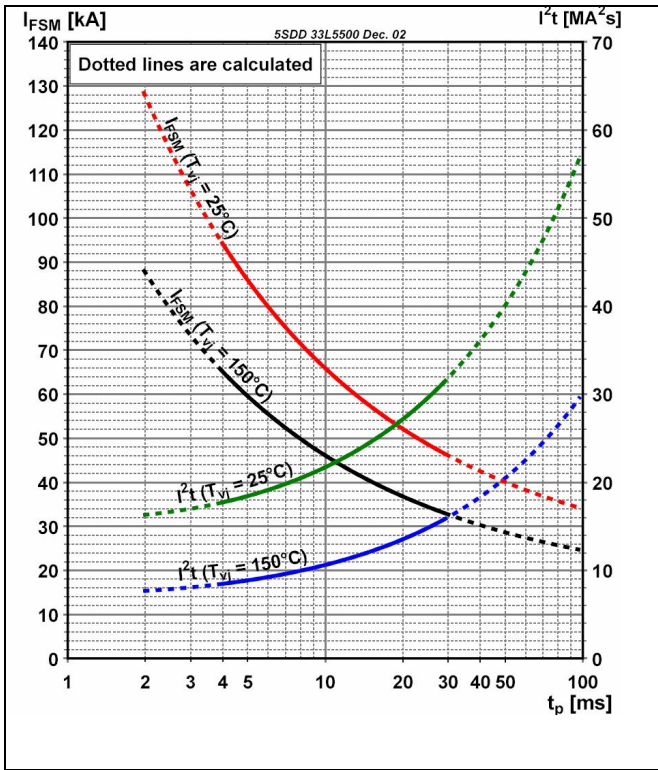

Fig. 6 Surge on-state current vs. number of pulses. Half-sine wave, 10 ms, 50Hz.

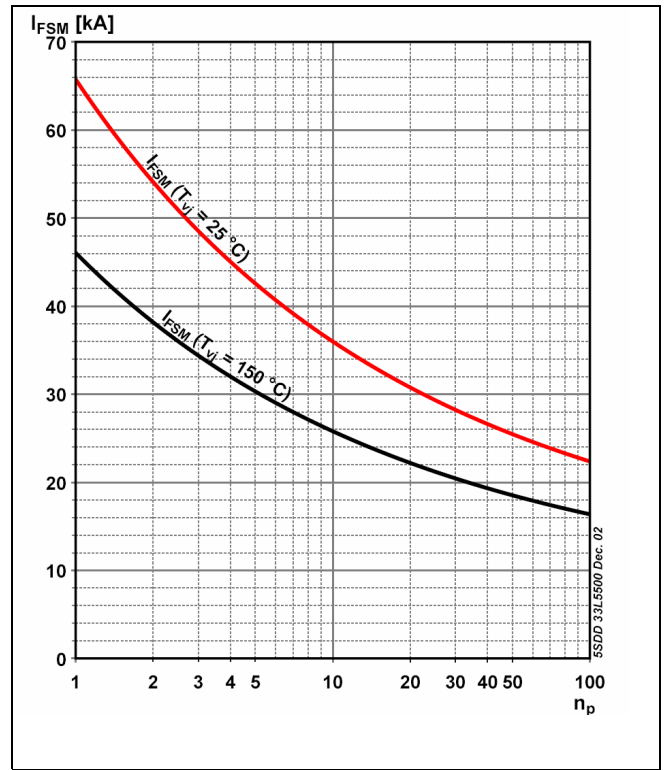

Fig. 7 Surge on-state current vs. number of pulses. Half-sine wave, 10 ms, 50Hz.

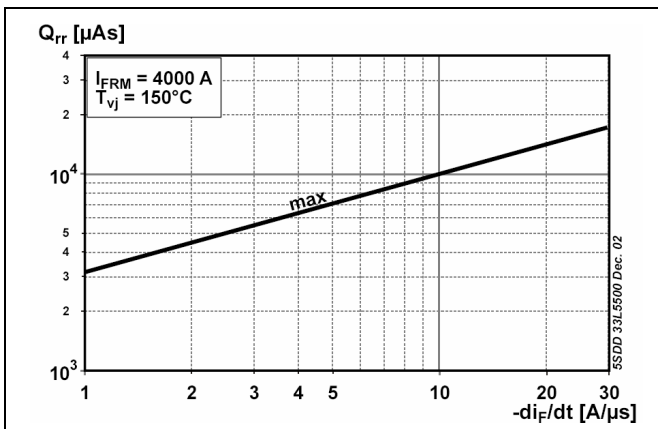

Fig. 8 Recovery charge vs. decay rate of on-state current.

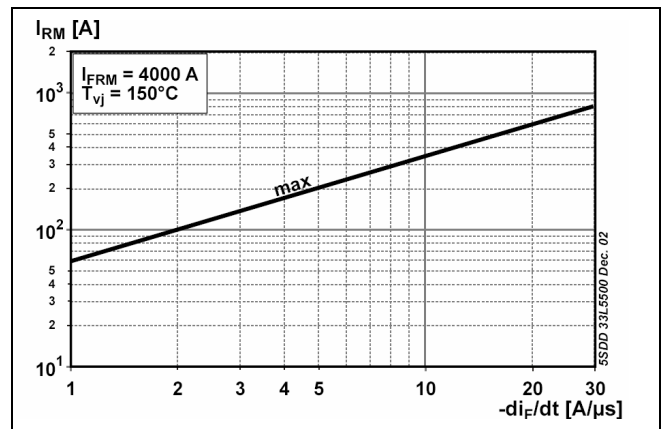

Fig. 9 Peak reverse recovery current vs. decay rate of on-state current.

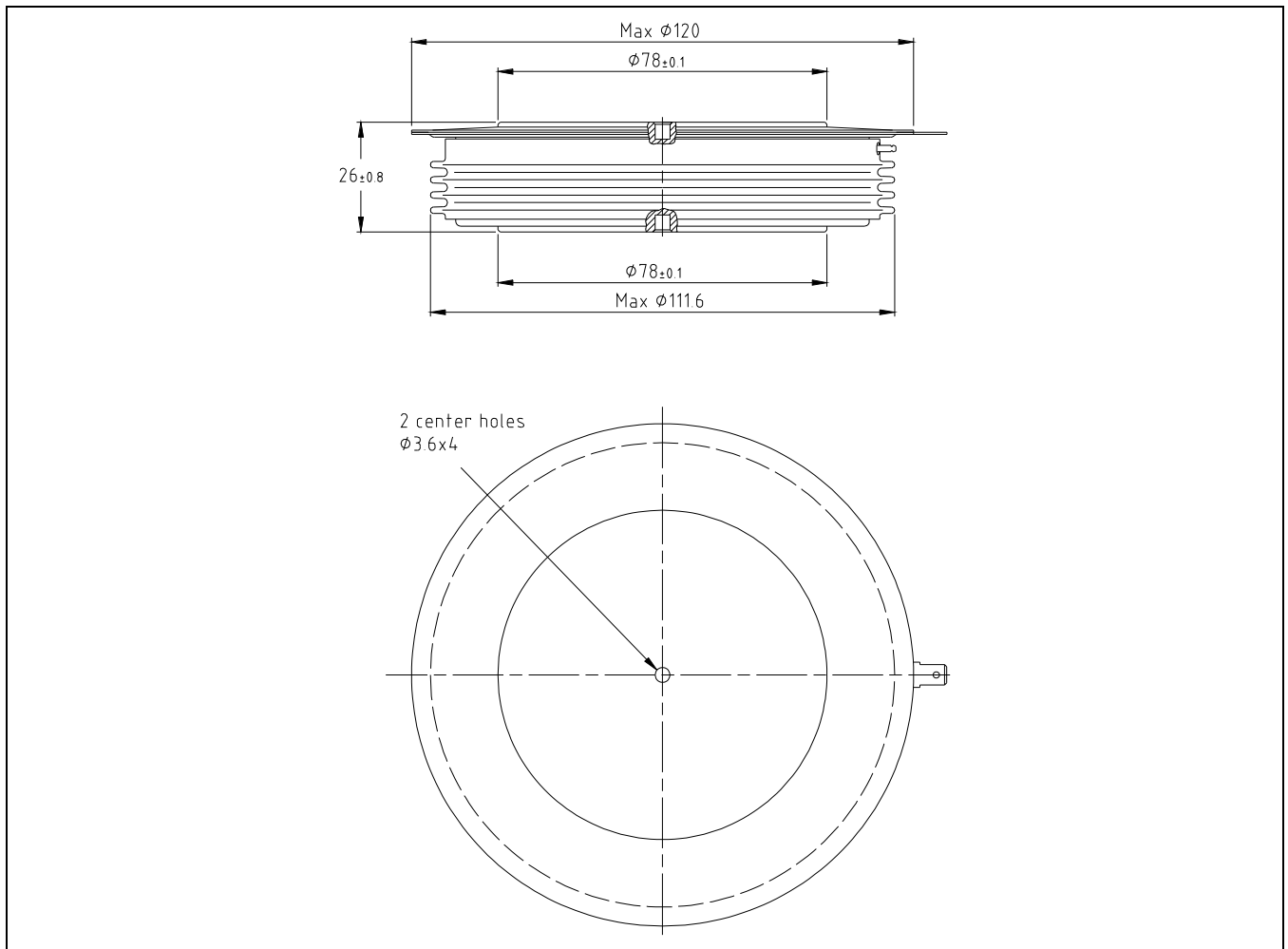

Fig. 10 Outline drawing. All dimensions are in millimeters and represent nominal values unless stated otherwise.

Related application notes:

Doc. Nr	Titel
5SYA 2020	Design of RC-Snubbers for Phase Control Applications
5SYA 2029	Designing Large Rectifiers with High Power Diodes
5SYA 2036	Recommendations regarding mechanical clamping of Press Pack High Power Semiconductors

Please refer to <http://www.abb.com/semiconductors> for actual versions.

ABB Switzerland Ltd, Semiconductors reserves the right to change specifications without notice.



ABB Switzerland Ltd
Semiconductors
 Fabrikstrasse 3
 CH-5600 Lenzburg, Switzerland

Doc. No. 5SYA1168-00 March 05

Telephone +41 (0)58 586 1419
 Fax +41 (0)58 586 1306
 Email abbsem@ch.abb.com
 Internet www.abb.com/semiconductors