

V_{DRM}	=	4500 V
I_{TGQM}	=	4000 A
I_{TSM}	=	25×10^3 A
V_{T0}	=	2.1 V
r_T	=	0.58 mW
V_{Dclink}	=	2800 V

Asymmetric Gate turn-off Thyristor 5SGA 40L4501

Doc. No. 5SYA1208-02 March 05

- Patented free-floating silicon technology
- Low on-state and switching losses
- Annular gate electrode
- Industry standard housing
- Cosmic radiation withstand rating

Blocking

Maximum rated values ¹⁾

Parameter	Symbol	Conditions	min	typ	max	Unit
Repetitive peak off-state voltage	V_{DRM}	$V_{GR} \geq 2$ V			4500	V
Repetitive peak reverse voltage	V_{RRM}				17	V
Permanent DC voltage for 100 FIT failure rate	$V_{DC-link}$	Ambient cosmic radiation at sea level in open air.			2800	V

Characteristic values

Parameter	Symbol	Conditions	min	typ	max	Unit
Repetitive peak off-state current	I_{DRM}	$V_D = V_{DRM}, V_{GR} \geq 2$ V			100	mA
Repetitive peak reverse current	I_{RRM}	$V_R = V_{RRM}, R_{GK} = \infty \Omega$			50	mA

Mechanical data

Maximum rated values ¹⁾

Parameter	Symbol	Conditions	min	typ	max	Unit
Mounting force	F_m		36	40	44	kN

Characteristic values

Parameter	Symbol	Conditions	min	typ	max	Unit
Pole-piece diameter	D_p	± 0.1 mm		85		mm
Housing thickness	H		25.6		26.1	mm
Weight	m				1.5	kg
Surface creepage distance	D_s	Anode to Gate	33			mm
Air strike distance	D_a	Anode to Gate	14			mm

1) Maximum rated values indicate limits beyond which damage to the device may occur

ABB Switzerland Ltd, Semiconductors reserves the right to change specifications without notice.



GTO Data

On-state

Maximum rated values ¹⁾

Parameter	Symbol	Conditions	min	typ	max	Unit
Max. average on-state current	$I_{T(AV)M}$	Half sine wave, $T_C = 85^\circ\text{C}$			1000	A
Max. RMS on-state current	$I_{T(RMS)}$				1570	A
Max. peak non-repetitive surge current	I_{TSM}	$t_p = 10\text{ ms}$, $T_{vj} = 125^\circ\text{C}$, sine wave After Surge: $V_D = V_R = 0\text{ V}$			25×10^3	A
Limiting load integral	I^2t				3.1×10^6	A^2s
Max. peak non-repetitive surge current	I_{TSM}	$t_p = 1\text{ ms}$, $T_{vj} = 125^\circ\text{C}$, sine wave After Surge: $V_D = V_R = 0\text{ V}$			40×10^3	A
Limiting load integral	I^2t				800×10^3	A^2s

Characteristic values

Parameter	Symbol	Conditions	min	typ	max	Unit
On-state voltage	V_T	$I_T = 4000\text{ A}$, $T_{vj} = 125^\circ\text{C}$			4.4	V
Threshold voltage	$V_{(T0)}$	$T_{vj} = 125^\circ\text{C}$			2.1	V
Slope resistance	r_T	$I_T = 400 \dots 5000\text{ A}$			0.58	$\text{m}\Omega$
Holding current	I_H	$T_{vj} = 25^\circ\text{C}$			100	A

Turn-on switching

Maximum rated values ¹⁾

Parameter	Symbol	Conditions	min	typ	max	Unit
Critical rate of rise of on-state current	di_T/dt_{cr}	$T_{vj} = 125^\circ\text{C}$, $f = 200\text{ Hz}$ $I_T = 4000\text{ A}$, $I_{GM} = 50\text{ A}$			500	$\text{A}/\mu\text{s}$
Critical rate of rise of on-state current	di_T/dt_{cr}	$di_G/dt = 40\text{ A}/\mu\text{s}$, $f = 1\text{ Hz}$			1000	$\text{A}/\mu\text{s}$
Min. on-time	t_{on}	$V_D = 0.5 V_{DRM}$, $T_{vj} = 125^\circ\text{C}$ $I_T = 4000\text{ A}$, $di/dt = 300\text{ A}/\mu\text{s}$, $I_{GM} = 50\text{ A}$, $di_G/dt = 40\text{ A}/\mu\text{s}$, $C_S = 6\text{ }\mu\text{F}$, $R_S = 5\text{ }\Omega$	100			μs

Characteristic values

Parameter	Symbol	Conditions	min	typ	max	Unit
Turn-on delay time	t_d	$V_D = 0.5 V_{DRM}$, $T_{vj} = 125^\circ\text{C}$ $I_T = 4000\text{ A}$, $di/dt = 300\text{ A}/\mu\text{s}$,			2.5	μs
Rise time	t_r	$I_{GM} = 50\text{ A}$, $di_G/dt = 40\text{ A}/\mu\text{s}$,			5	μs
Turn-on energy per pulse	E_{on}	$C_S = 6\text{ }\mu\text{F}$, $R_S = 5\text{ }\Omega$			3.3	J

Turn-off switching

Maximum rated values ¹⁾

Parameter	Symbol	Conditions	min	typ	max	Unit
Max. controllable turn-off current	I_{TGQM}	$V_{DM} \leq V_{DRM}$, $di_{GQ}/dt = 40\text{ A}/\mu\text{s}$, $C_S = 6\text{ }\mu\text{F}$, $L_S \leq 0.3\text{ }\mu\text{H}$			4000	A
Min. off-time	t_{off}	$V_D = 0.5 V_{DRM}$, $T_{vj} = 125^\circ\text{C}$ $V_{DM} \leq V_{DRM}$, $di_{GQ}/dt = 40\text{ A}/\mu\text{s}$, $I_{TGQ} = I_{TGQM}$, $R_S = 5\text{ }\Omega$, $C_S = 6\text{ }\mu\text{F}$, $L_S = 0.3\text{ }\mu\text{H}$	100			μs

Characteristic values

Parameter	Symbol	Conditions	min	typ	max	Unit
Storage time	t_S	$V_D = 0.5 V_{DRM}$, $T_{vj} = 125^\circ\text{C}$			27	μs
Fall time	t_f	$V_{DM} \leq V_{DRM}$, $di_{GQ}/dt = 40\text{ A}/\mu\text{s}$, $I_{TGQ} = I_{TGQM}$,			3	μs
Turn-on energy per pulse	E_{off}	$R_S = 5\text{ }\Omega$, $C_S = 6\text{ }\mu\text{F}$, $L_S = 0.3\text{ }\mu\text{H}$			14	J
Peak turn-off gate current	I_{GQM}				1100	A

Gate

Maximum rated values ¹⁾

Parameter	Symbol	Conditions	min	typ	max	Unit
Repetitive peak reverse voltage	V _{GRM}				17	V
Repetitive peak reverse current	I _{GRM}	V _{GR} = V _{GRM}			50	mA

Characteristic values

Parameter	Symbol	Conditions	min	typ	max	Unit
Gate trigger voltage	V _{GT}	T _{vj} = 25°C,		1.2		V
Gate trigger current	I _{GT}	V _D = 24 V, R _A = 0.1 Ω		4		A

Thermal

Maximum rated values ¹⁾

Parameter	Symbol	Conditions	min	typ	max	Unit
Junction operating temperature	T _{vj}		-40		125	°C
Storage temperature range	T _{stg}		-40		125	°C

Characteristic values

Parameter	Symbol	Conditions	min	typ	max	Unit
Thermal resistance junction to case	R _{th(j-c)}	Double side cooled			11	K/kW
	R _{th(j-c)A}	Anode side cooled			20	K/kW
	R _{th(j-c)C}	Cathode side cooled			25	K/kW
Thermal resistance case to heatsink (Double side cooled)	R _{th(c-h)}	Single side cooled			6	K/kW
	R _{th(c-h)}	Double side cooled			3	K/kW

Analytical function for transient thermal impedance:

$$Z_{th(j-c)}(t) = \sum_{i=1}^n R_i(1 - e^{-t/\tau_i})$$

i	1	2	3	4
R _i (K/kW)	7.313	1.974	1.218	0.501
τ _i (s)	0.5400	0.0939	0.0117	0.0036

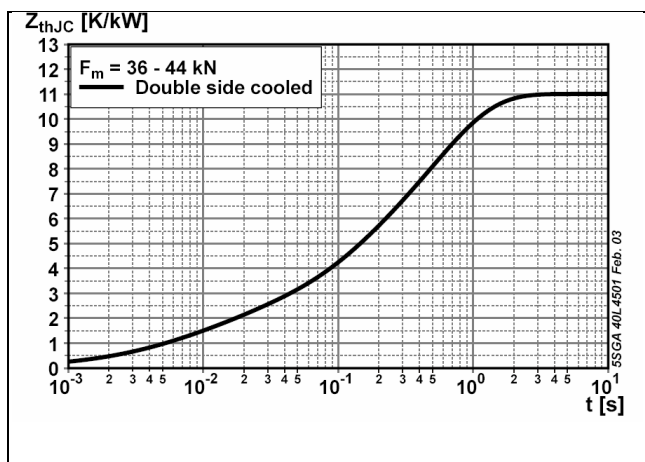

Fig. 1 Transient thermal impedance, junction to case

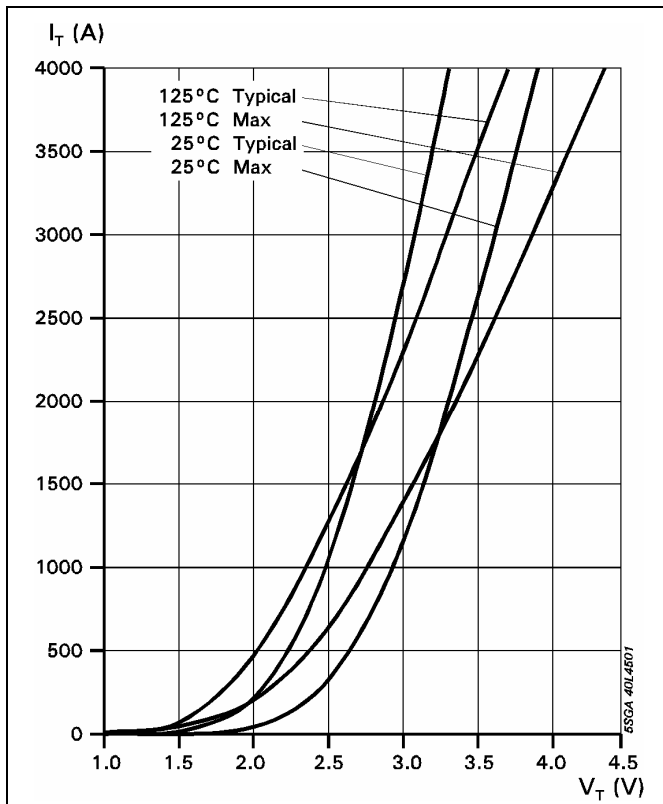

Fig. 2 On-state characteristics

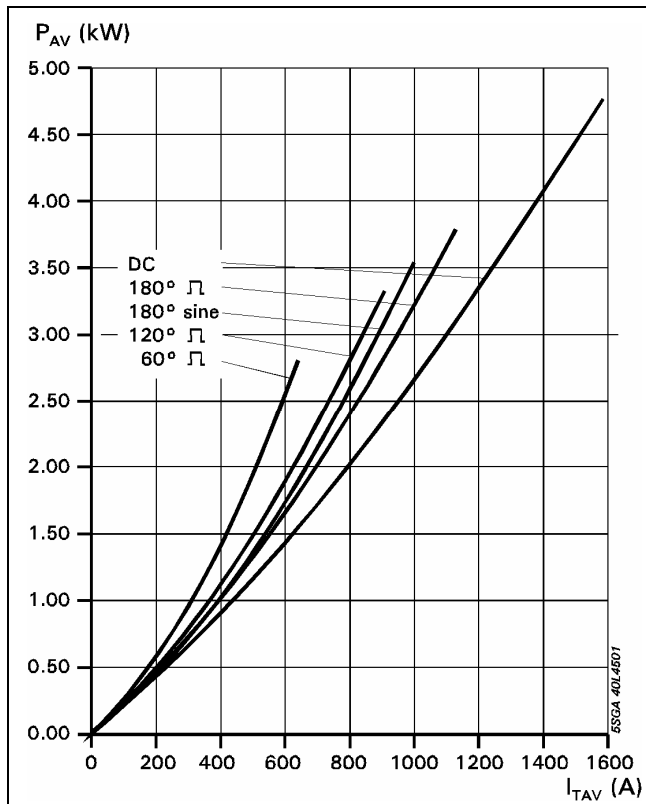

Fig. 3 Average on-state power dissipation vs. average on-state current

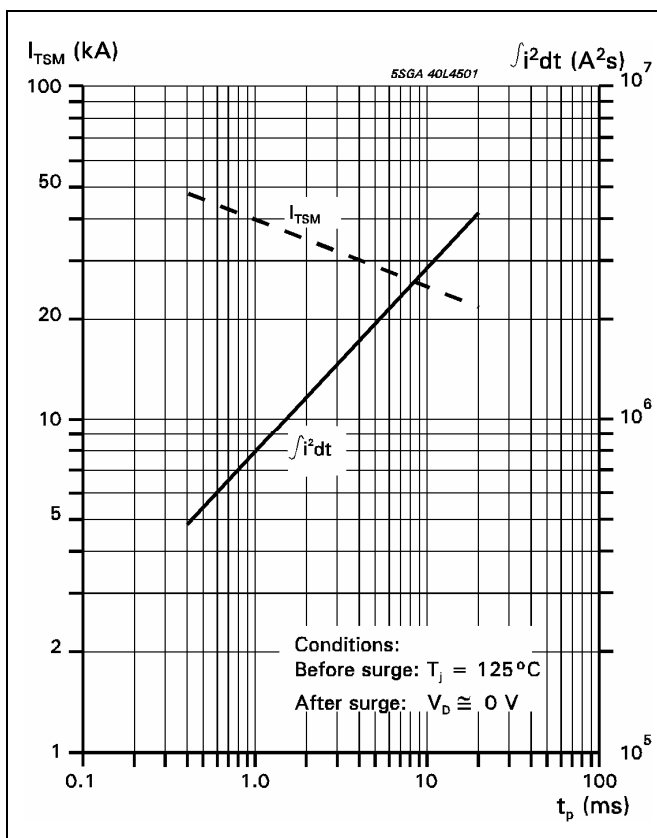

Fig. 4 Surge current and fusing integral vs. pulse width

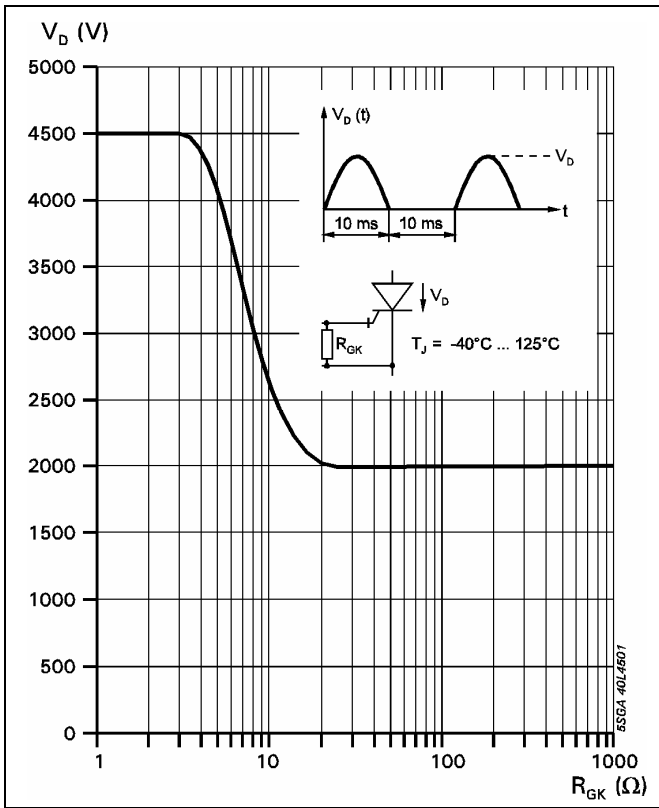

Fig. 5 Forward blocking voltage vs. gate-cathode resistance

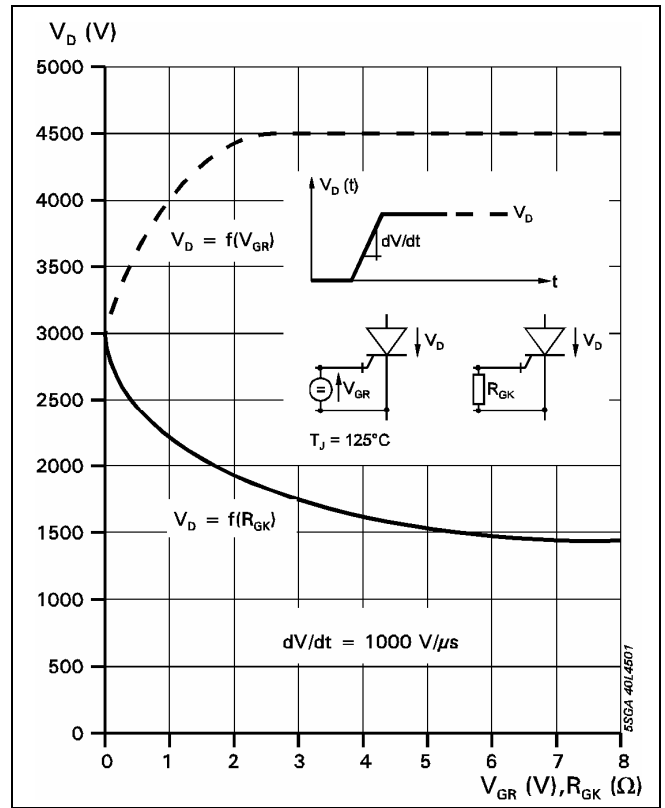

Fig. 6 Static dv/dt capability; forward blocking voltage vs. neg. gate voltage or gate cathode resistance

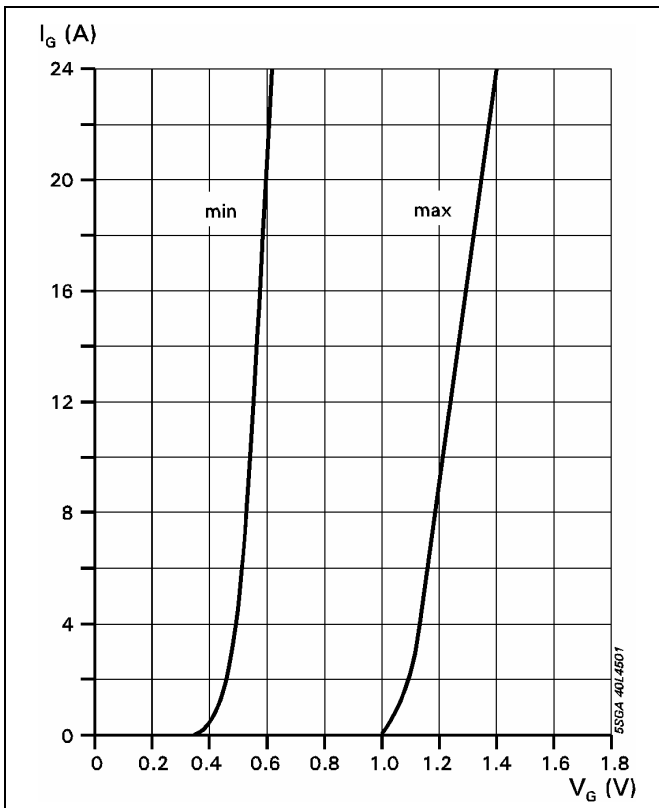

Fig. 7 Forward gate current vs. forward gate voltage

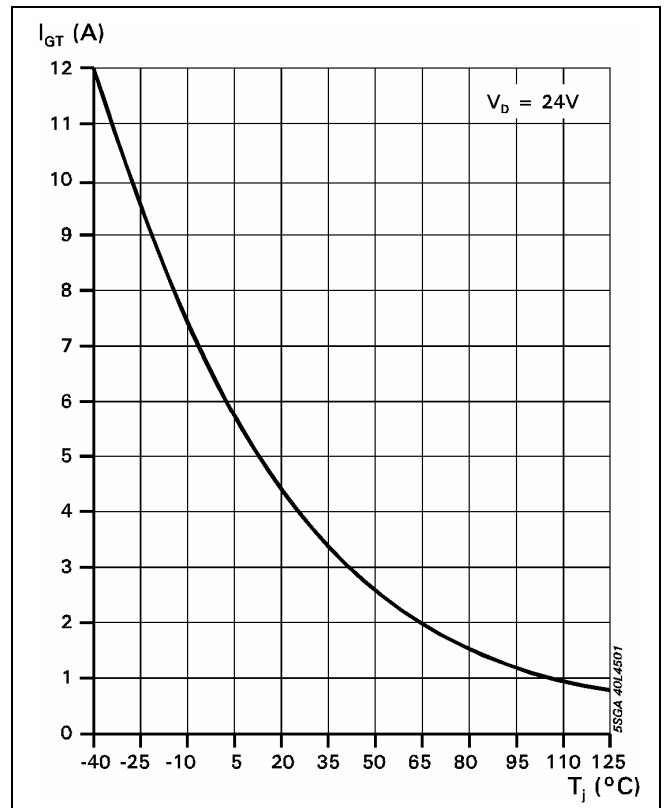

Fig. 8 Gate trigger current vs. junction temperature

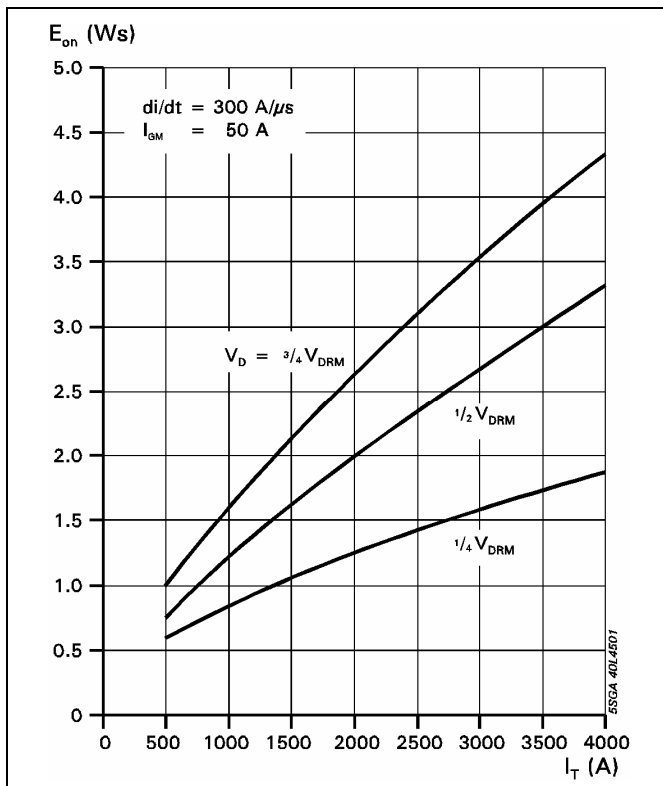

Fig. 9 Turn-on energy per pulse vs. on-state current and turn-on voltage

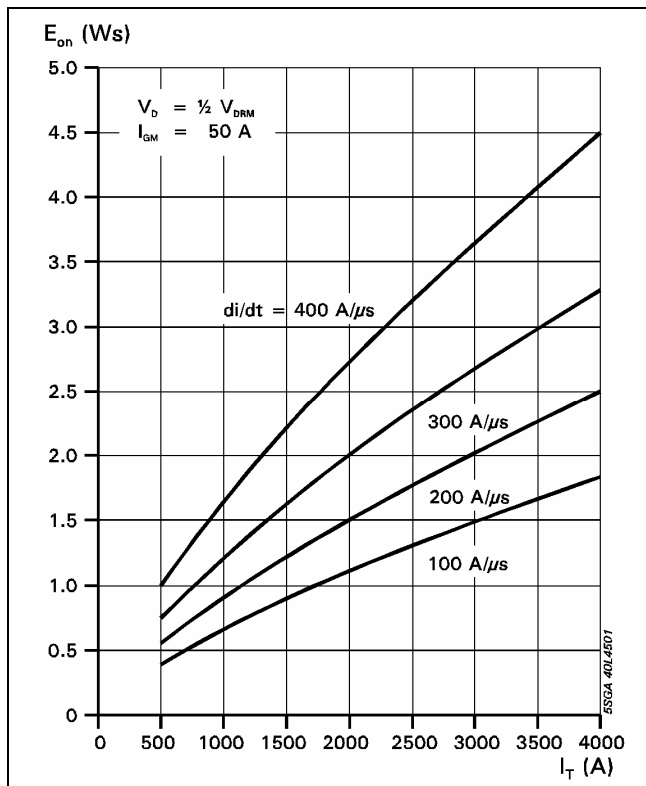

Fig. 10 Turn-on energy per pulse vs. on-state current and current rise rate

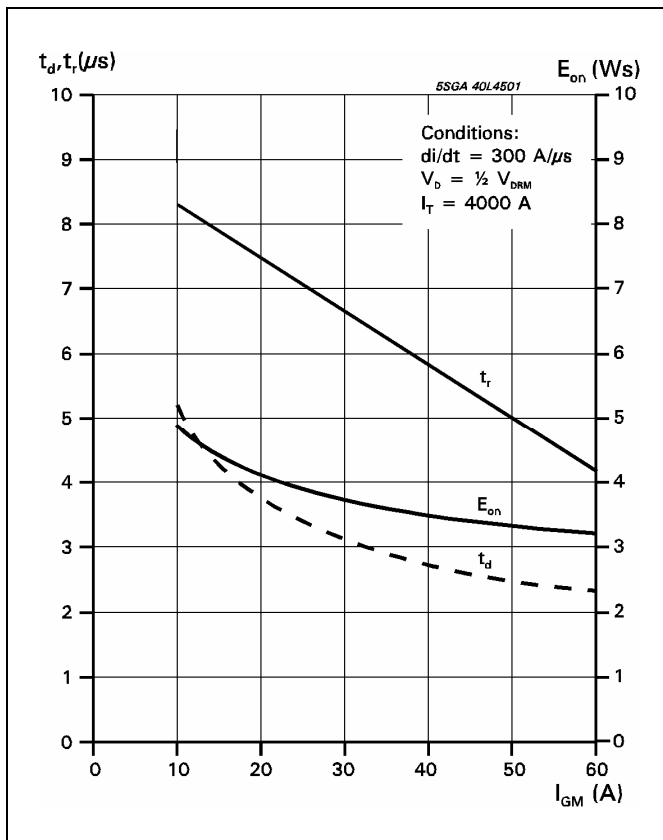

Fig. 11 Turn-on energy per pulse vs. on-state current and turn-on voltage

Common Test conditions:

- $di_G/dt = 40 \text{ A}/\mu\text{s}$
- $C_S = 6 \mu\text{F}$
- $R_S = 5 \Omega$
- $T_j = 125 \text{ }^\circ\text{C}$

Definition of Turn-on energy:

$$E_{on} = \int_0^{20 \text{ ms}} V_D \cdot I_T dt \quad (t = 0, I_G = 0.1 \cdot I_{GM})$$

Definition of Turn-off energy:

$$E_{off} = \int_0^{40 \text{ ns}} V_D \cdot I_T dt \quad (t = 0, I_T = 0.9 \cdot I_{TQ})$$

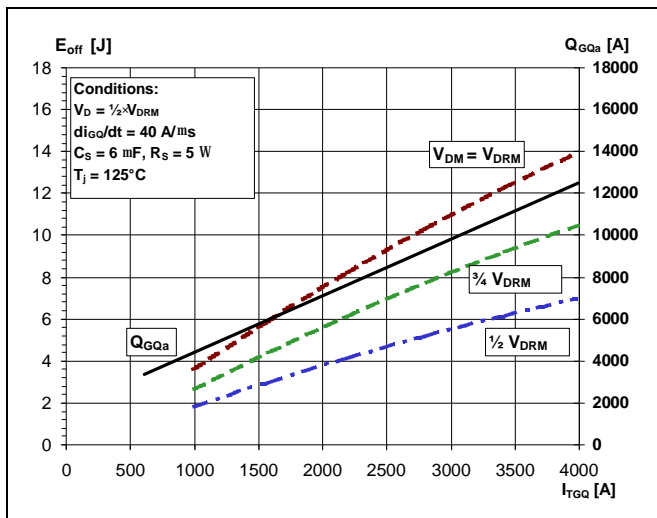

Fig. 12 Turn-off energy per pulse vs. turn-off current and peak turn-off voltage, extracted gate charge vs. turn-off current

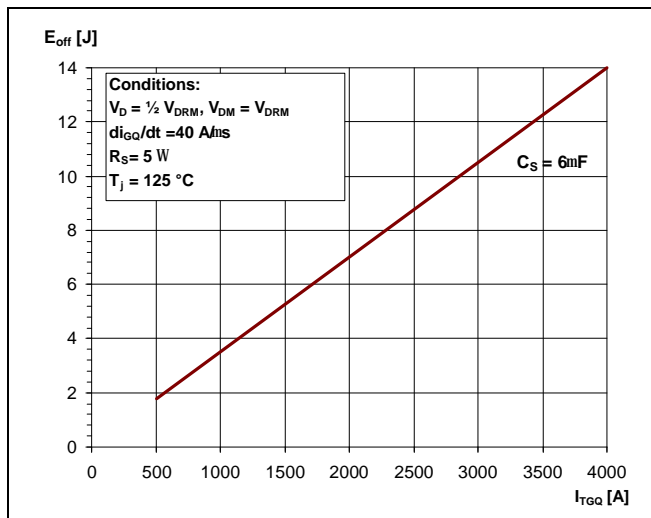

Fig. 13 Turn-off energy per pulse vs. turn-off current and snubber capacitance

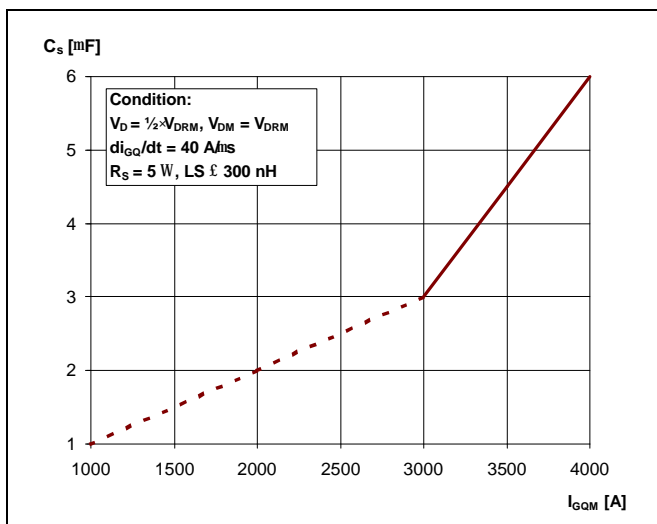

Fig. 14 Required snubber capacitor vs. max allowable turn-off current

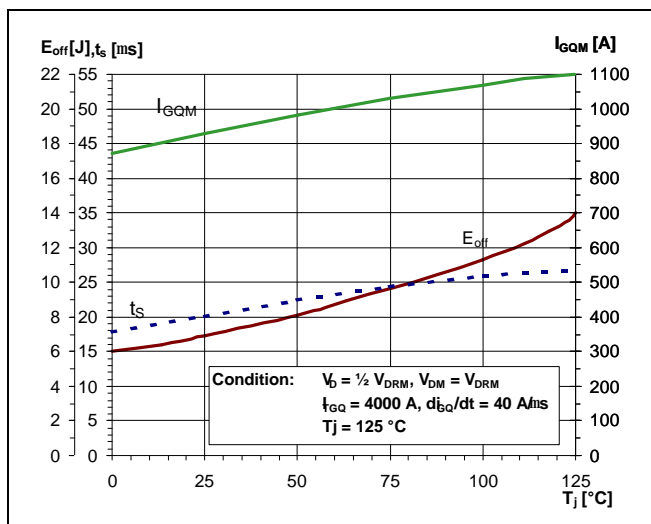

Fig. 15 Turn-off energy per pulse, storage time and peak turn-off gate current vs. junction temperature

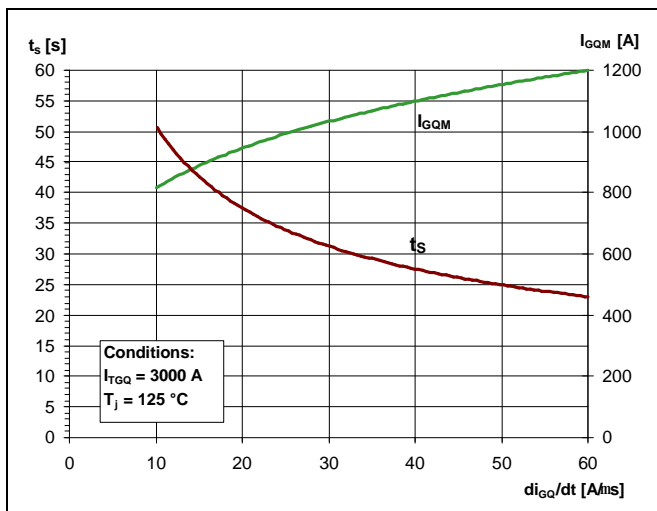

Fig. 16 Storage time and peak turn-off gate current vs. neg. gate current rise rate

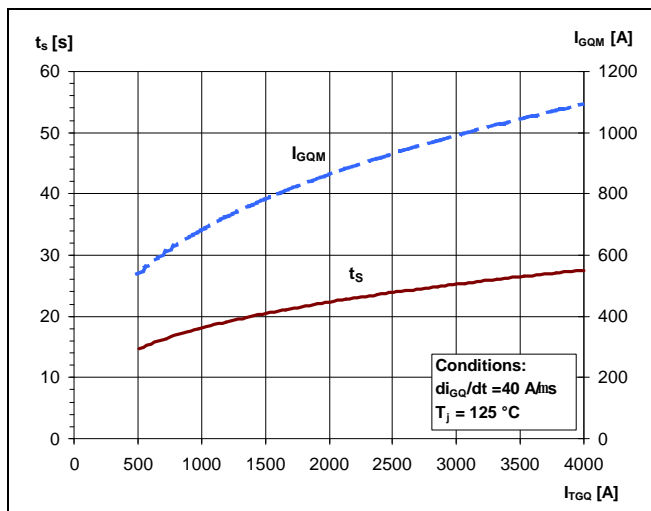

Fig. 17 Storage time and peak turn-off gate current vs. turn-off current

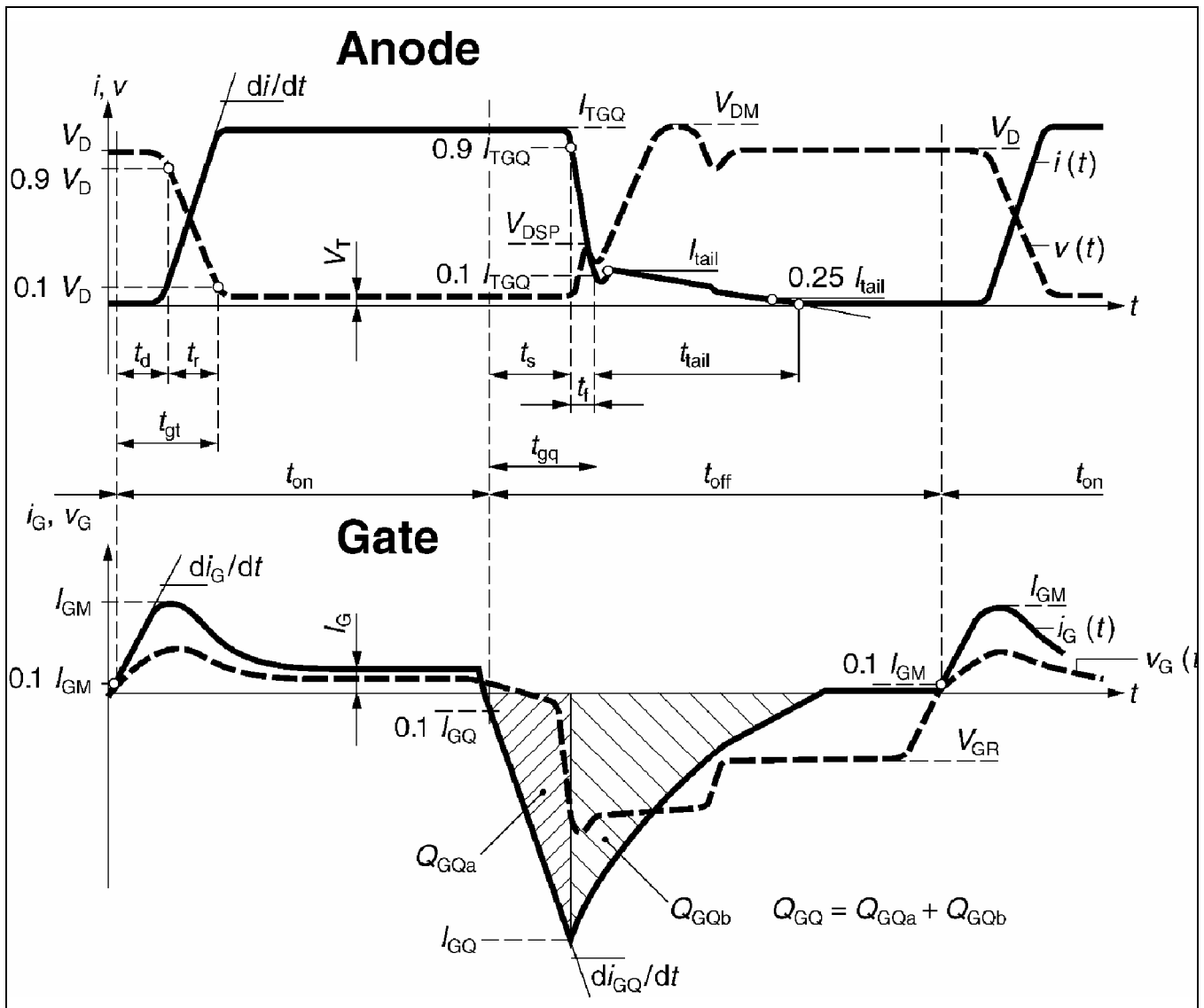

Fig. 18 General current and voltage waveforms with GTO-specific symbols

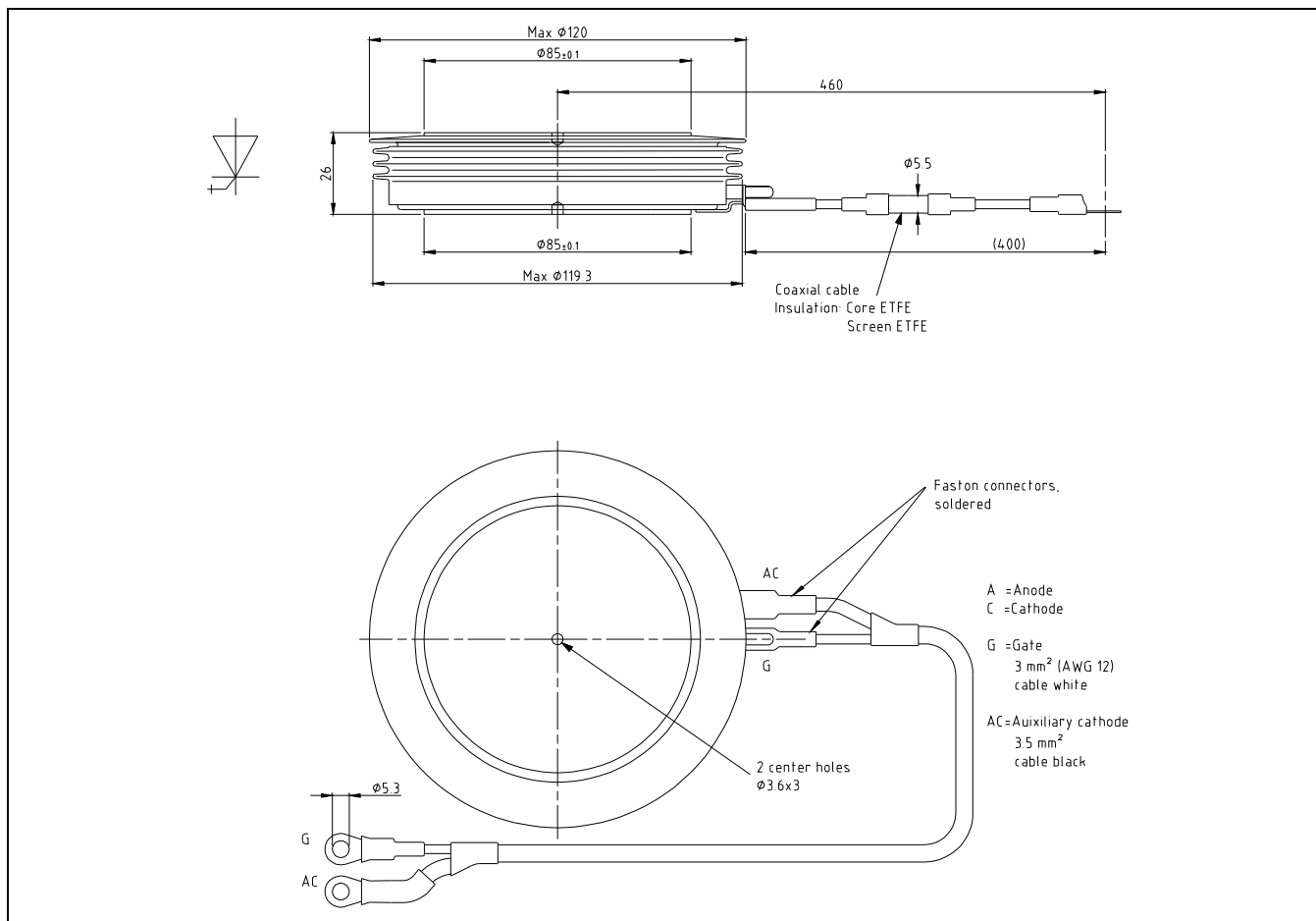

Fig. 19 Outline drawing; all dimensions are in millimeters and represent nominal values unless stated otherwise

Reverse avalanche capability

In operation with an antiparallel freewheeling diode, the GTO reverse voltage V_R may exceed the rate value V_{RRM} due to stray inductance and diode turn-on voltage spike at high di/dt . The GTO is then driven into reverse avalanche. This condition is not dangerous for the GTO provided avalanche time and current are below 10 μ s and 1000 A respectively. However, gate voltage must remain negative during this time. Recommendation : $V_{GR} = 10 \dots 15$ V.

Related documents:

5SYA 2036	Recommendations regarding mechanical clamping of Press Pack High Power Semiconductors
5SYA 2046	Cosmic Ray
5SZK 9104	Specification of enviromental class for pressure contact GTO, STORAGE available on request, please contact factory
5SZK 9105	Specification of enviromental class for pressure contact GTO, TRANSPORTATION available on request, please contact factory

Please refer to <http://www.abb.com/semiconductors> for actual versions.

ABB Switzerland Ltd, Semiconductors reserves the right to change specifications without notice.



ABB Switzerland Ltd
Semiconductors
 Fabrikstrasse 3
 CH-5600 Lenzburg, Switzerland

Doc. No. 5SYA1208-02 March 05

Telephone +41 (0)58 586 1419
 Fax +41 (0)58 586 1306
 Email abbsem@ch.abb.com
 Internet www.abb.com/semiconductors