

$V_{DRM}$	= 2800	V
$I_{T(AV)M}$	= 1512	A
$I_{T(RMS)}$	= 2375	A
$I_{TSM}$	= $23.6 \times 10^3$	A
$V_{(T0)}$	= 1.02	V
$r_T$	= 0.265	mW

# Phase Control Thyristor

## 5STP 16F2801

Doc. No. 5SYA1064-01 March 05

- Low on-state and switching losses
- Designed for traction, energy and industrial applications
- Optimum power handling capability

### Blocking

*Maximum rated values*<sup>1)</sup>

Symbol	Conditions	5STP 16F2801	5STP 16F2601	5STP 16F2401
$V_{DRM}, V_{RRM}$	$f = 50 \text{ Hz}, t_p = 10 \text{ ms}$	2800 V	2600 V	2400 V
$dV/dt_{crit}$	Exp. to 1880 V, $T_{vj} = 125^\circ\text{C}$	1000 V/ $\mu\text{s}$		

*Characteristic values*

Parameter	Symbol	Conditions	min	typ	max	Unit
Forward leakage current	$I_{DRM}$	$V_{DRM}, T_{vj} = 125^\circ\text{C}$			150	mA
Reverse leakage current	$I_{RRM}$	$V_{RRM}, T_{vj} = 125^\circ\text{C}$			150	mA

### Mechanical data

*Maximum rated values*<sup>1)</sup>

Parameter	Symbol	Conditions	min	typ	max	Unit
Mounting force	$F_M$		20	22	24	kN
Acceleration	a	Device unclamped			50	$\text{m/s}^2$
Acceleration	a	Device clamped			100	$\text{m/s}^2$

*Characteristic values*

Parameter	Symbol	Conditions	min	typ	max	Unit
Weight	m				0.48	kg
Surface creepage distance	$D_s$		25			mm
Air strike distance	$D_a$		13			mm

1) Maximum rated values indicate limits beyond which damage to the device may occur

ABB Switzerland Ltd, Semiconductors reserves the right to change specifications without notice.



## On-state

### Maximum rated values <sup>1)</sup>

Parameter	Symbol	Conditions	min	typ	max	Unit
Average on-state current	$I_{T(AV)M}$	Half sine wave, $T_c = 70^\circ\text{C}$			1512	A
RMS on-state current	$I_{T(RMS)}$				2375	A
Peak non-repetitive surge current	$I_{TSM}$	$t_p = 10\text{ ms}$ , $T_{vj} = 125^\circ\text{C}$ , $V_D = V_R = 0\text{ V}$			$23.6 \times 10^3$	A
Limiting load integral	$I^2t$				$2.79 \times 10^6$	$\text{A}^2\text{s}$
Peak non-repetitive surge current	$I_{TSM}$	$t_p = 8.3\text{ ms}$ , $T_{vj} = 125^\circ\text{C}$ , $V_D = V_R = 0\text{ V}$			$25.2 \times 10^3$	A
Limiting load integral	$I^2t$				$2.64 \times 10^6$	$\text{A}^2\text{s}$

### Characteristic values

Parameter	Symbol	Conditions	min	typ	max	Unit
On-state voltage	$V_T$	$I_T = 2000\text{ A}$ , $T_{vj} = 125^\circ\text{C}$			1.55	V
Threshold voltage	$V_{(T0)}$	$I_T = 1900\text{ A} - 5800\text{ A}$ , $T_{vj} = 125^\circ\text{C}$			1.02	V
Slope resistance	$r_T$				0.265	$\text{m}\Omega$
Holding current	$I_H$	$T_{vj} = 25^\circ\text{C}$		170		mA
		$T_{vj} = 125^\circ\text{C}$		90		mA
Latching current	$I_L$	$T_{vj} = 25^\circ\text{C}$		450		mA
		$T_{vj} = 125^\circ\text{C}$		350		mA

## Switching

### Maximum rated values <sup>1)</sup>

Parameter	Symbol	Conditions	min	typ	max	Unit
Critical rate of rise of on-state current	$di/dt_{crit}$	$T_{vj} = 125^\circ\text{C}$ , $I_T = I_{T(AV)}$ , Cont. $f = 50\text{ Hz}$			200	$\text{A}/\mu\text{s}$
Critical rate of rise of on-state current	$di/dt_{crit}$	$V_D \leq 1880\text{ V}$ , $I_{FG} = 2\text{ A}$ , $t_r = 0.3\ \mu\text{s}$ Cont. $f = 1\text{ Hz}$			1000	$\text{A}/\mu\text{s}$
Circuit-commutated turn-off time	$t_q$	$T_{vj} = 125^\circ\text{C}$ , $I_{TRM} = 2000\text{ A}$ , $V_R = 200\text{ V}$ , $di_T/dt = -12.5\text{ A}/\mu\text{s}$ , $V_D \leq 0.67 \cdot V_{DRM}$ , $dv_D/dt = 50\text{ V}/\mu\text{s}$		200		$\mu\text{s}$

### Characteristic values

Parameter	Symbol	Conditions	min	typ	max	Unit
Recovery charge	$Q_{rr}$	$T_{vj} = 125^\circ\text{C}$ , $I_{TRM} = 2000\text{ A}$ , $V_R = 200\text{ V}$ , $di_T/dt = -12.5\text{ A}/\mu\text{s}$		2600		$\mu\text{As}$
Gate turn-on delay time	$t_{gd}$	$V_D = 0.4 \cdot V_{RM}$ , $I_{FG} = 2\text{ A}$ , $t_r = 0.3\ \mu\text{s}$ , $T_{vj} = 25^\circ\text{C}$			2	$\mu\text{s}$

## Triggering

Maximum rated values <sup>1)</sup>

Parameter	Symbol	Conditions	min	typ	max	Unit
Peak forward gate voltage	V <sub>FGM</sub>				12	V
Peak forward gate current	I <sub>FGM</sub>				10	A
Peak reverse gate voltage	V <sub>RGM</sub>				10	V
Mean forward gate power	P <sub>G(AV)</sub>				3	W

Characteristic values

Parameter	Symbol	Conditions	min	typ	max	Unit
Gate-trigger voltage	V <sub>GT</sub>	T <sub>vj</sub> = -40 °C			4	V
		T <sub>vj</sub> = 25 °C			3	
		T <sub>vj</sub> = 125 °C	0.25		2	
Gate-trigger current	I <sub>GT</sub>	T <sub>vj</sub> = -40 °C			500	mA
		T <sub>vj</sub> = 25 °C			250	
		T <sub>vj</sub> = 125 °C	10		150	

## Thermal

Maximum rated values <sup>1)</sup>

Parameter	Symbol	Conditions	min	typ	max	Unit
Operating junction temperature range	T <sub>vj</sub>		-40		125	°C
Storage temperature range	T <sub>stg</sub>		-40		125	°C

Characteristic values

Parameter	Symbol	Conditions	min	typ	max	Unit
Thermal resistance junction to case	R <sub>th(j-c)</sub>	Double-side cooled F <sub>m</sub> = 20...24 kN			16	K/kW
	R <sub>th(j-c)A</sub>	Anode-side cooled F <sub>m</sub> = 20...24 kN			25	K/kW
	R <sub>th(j-c)C</sub>	Cathode-side cooled F <sub>m</sub> = 20...24 kN			45	K/kW
Thermal resistance case to heatsink	R <sub>th(c-h)</sub>	Double-side cooled F <sub>m</sub> = 20...24 kN			4	K/kW
	R <sub>th(c-h)</sub>	Single-side cooled F <sub>m</sub> = 20...24 kN			8	K/kW

Analytical function for transient thermal impedance:

$$Z_{th(j-c)}(t) = \sum_{i=1}^n R_{th i} (1 - e^{-t/t_i})$$

i	1	2	3	4
R <sub>th i</sub> (K/kW)	5.500	7.240	2.000	1.340
τ <sub>i</sub> (s)	0.4653	0.1533	0.0375	0.0034

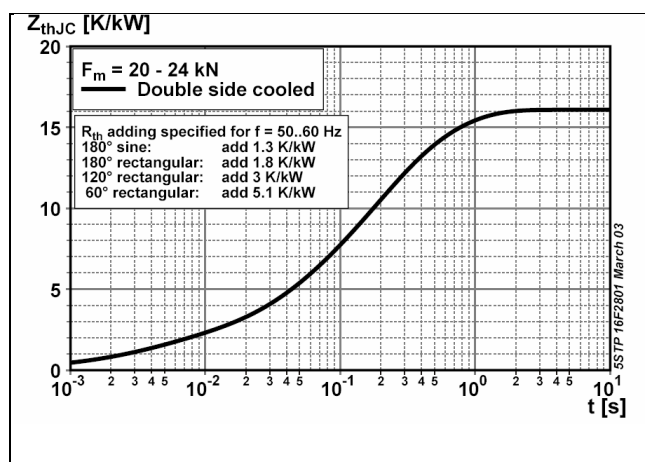

Fig. 1 Transient thermal impedance junction-to-case.

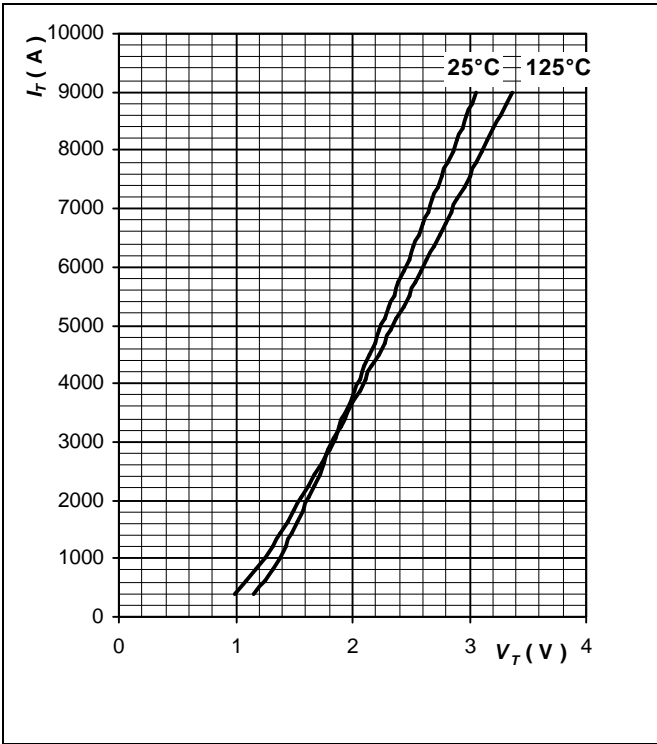

Fig. 2 Max. on-state voltage characteristics

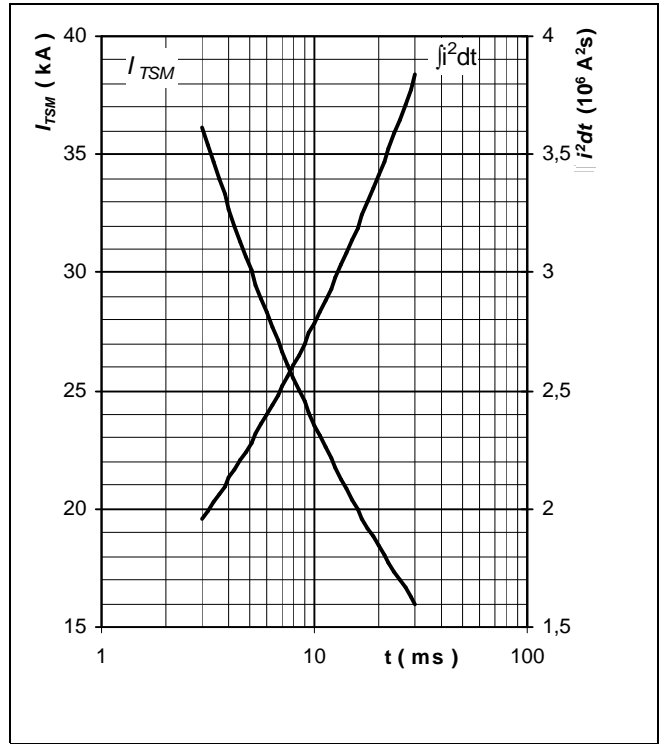

Fig. 3 Surge forward current vs. pulse length. Half sine wave, single pulse,  $V_R = 0$  V

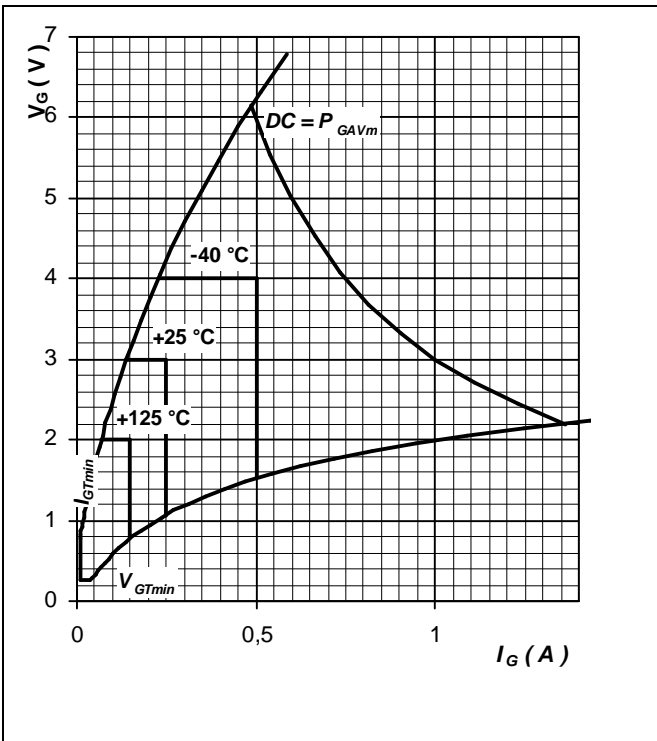

Fig. 4 Gate trigger characteristics

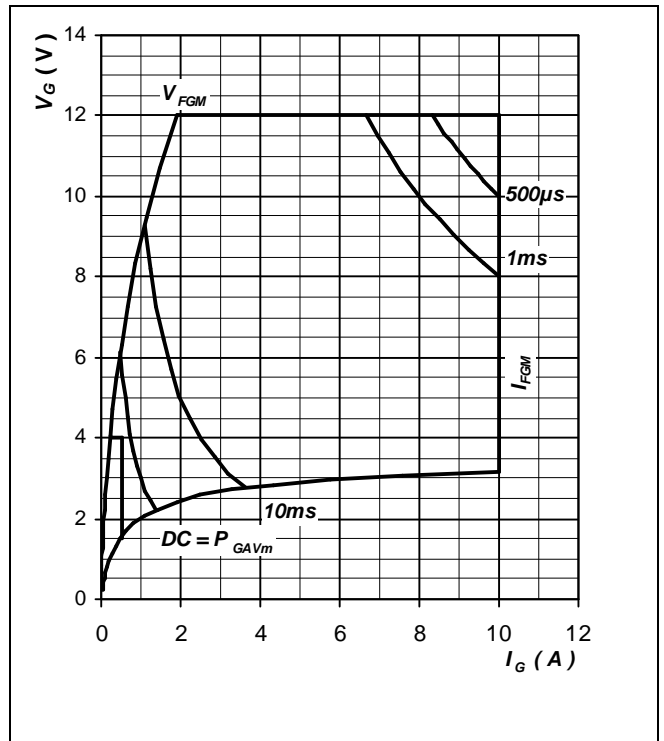
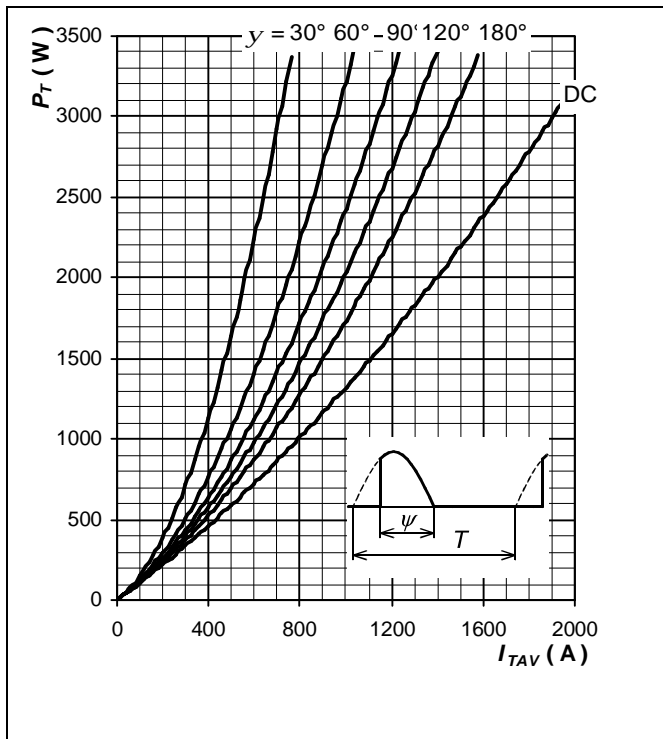
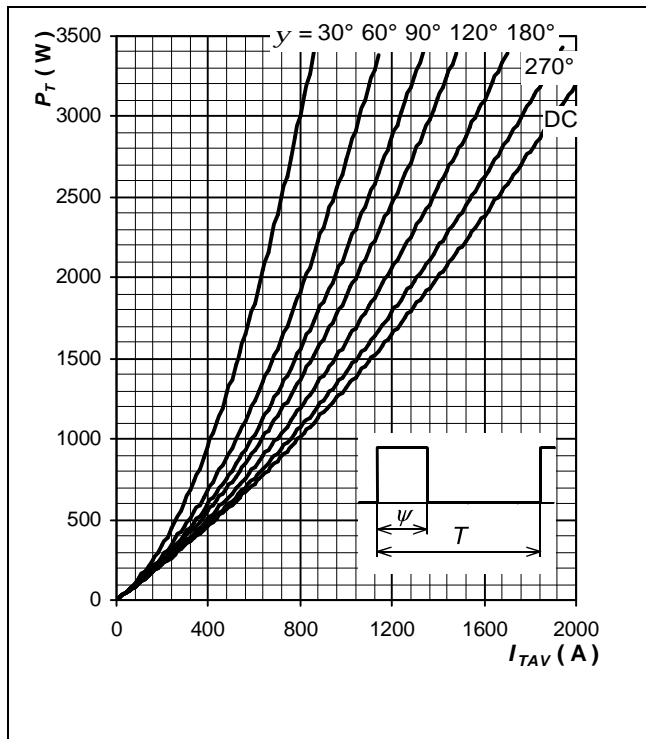

Fig. 5 Gate trigger characteristics



**Fig. 6** Forward power loss vs. average forward current, sine waveform,  $f = 50 \text{ Hz}$ ,  $T = 1/f$



**Fig. 7** Forward power loss vs. average forward current, square waveform,  $f = 50 \text{ Hz}$ ,  $T = 1/f$

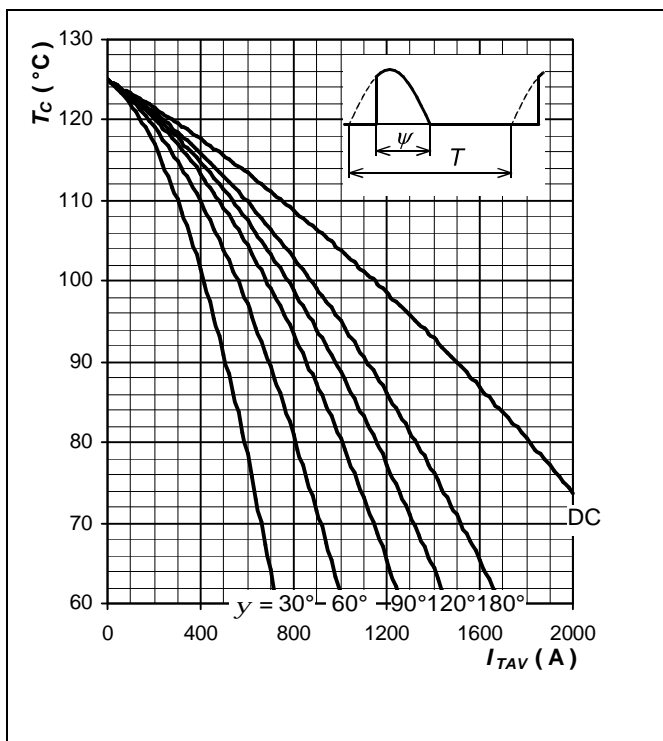

**Fig. 8** Max. case temperature vs. average forward current, sine waveform,  $f = 50 \text{ Hz}$ ,  $T = 1/f$

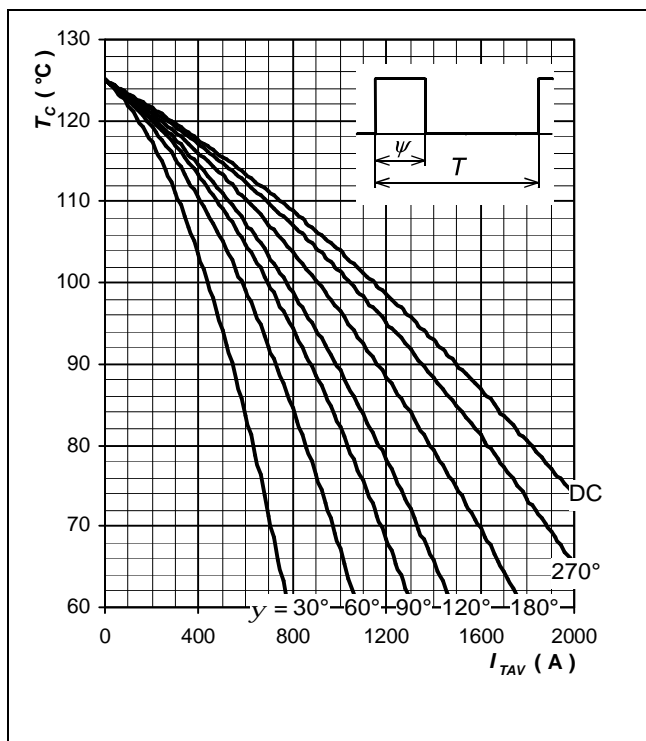

**Fig. 9** Max. case temperature vs. average forward current, square waveform,  $f = 50 \text{ Hz}$ ,  $T = 1/f$

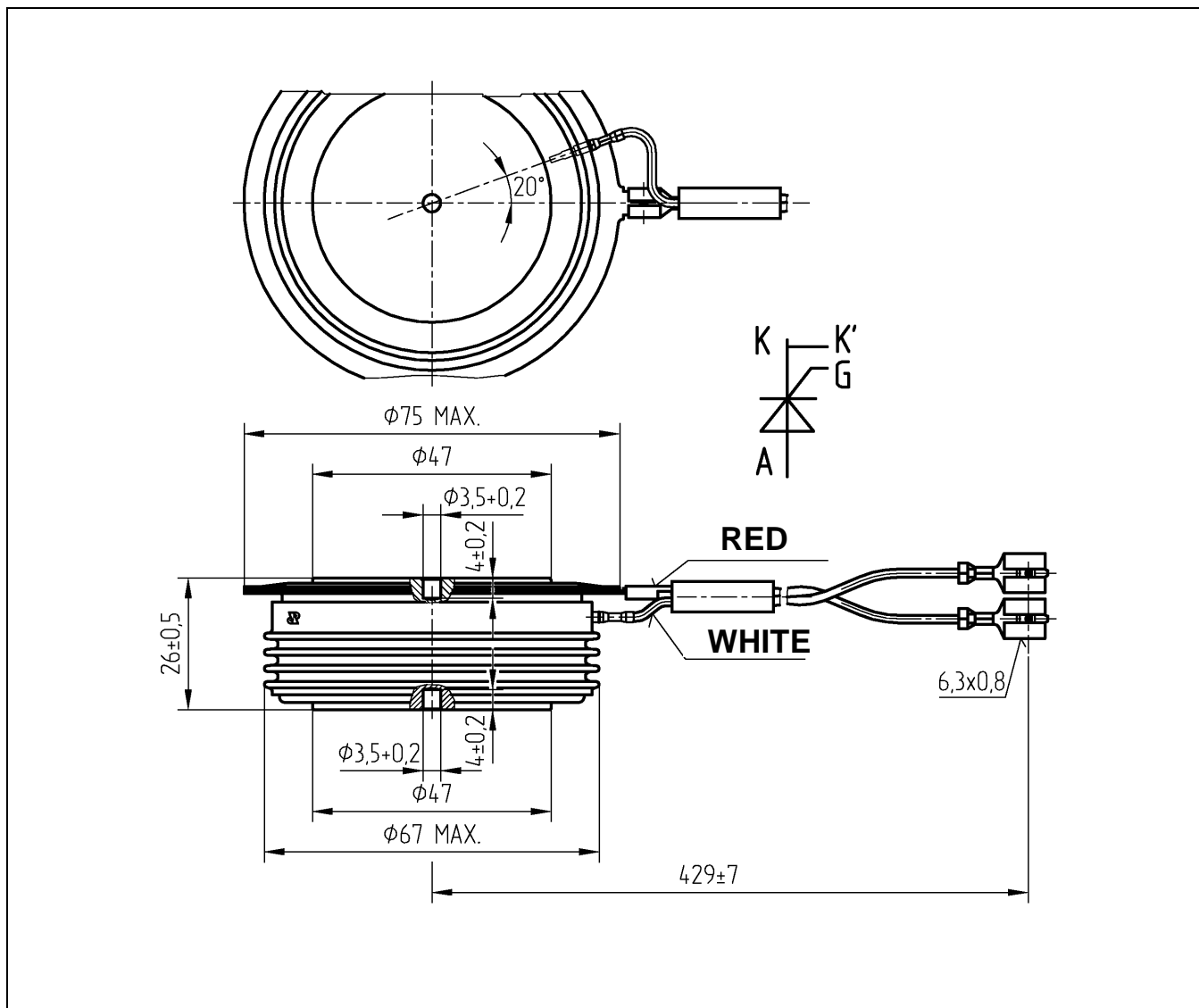

Fig. 10 Device Outline Drawing.

### Related application notes:

Doc. Nr	Titel
5SYA2020	Design of RC-Snubber for Phase Control Applications
5SYA2034	Gate-drive Recommendations for PCT's
5SYA 2036	Recommendations regarding mechanical clamping of Press Pack High Power Semiconductors

Please refer to <http://www.abb.com/semiconductors> for actual versions.

ABB Switzerland Ltd, Semiconductors reserves the right to change specifications without notice.



ABB Switzerland Ltd  
Semiconductors  
Fabrikstrasse 3  
CH-5600 Lenzburg, Switzerland

Doc. No. 5SYA1064-01 March 05

Telephone +41 (0)58 586 1419  
Fax +41 (0)58 586 1306  
Email [abbsem@ch.abb.com](mailto:abbsem@ch.abb.com)  
Internet [www.abb.com/semiconductors](http://www.abb.com/semiconductors)