

V_{DRM}	= 1800	V	<h1>Phase Control Thyristor</h1> <h2>5STP 30H1801</h2>
$I_{T(AV)M}$	= 3108	A	
$I_{T(RMS)}$	= 4882	A	
I_{TSM}	= 47×10^3	A	
$V_{(T0)}$	= 0.984	V	
r_T	= 0.081	mW	

Doc. No. 5SYA1066-01 March 05

- Low on-state and switching losses
- Designed for traction, energy and industrial applications
- Optimum power handling capability

Blocking

Maximum rated values ¹⁾

Symbol	Conditions	5STP 30H1801	5STP 30H1601	5STP 30H1401
V_{DRM}, V_{RRM}	$f = 50 \text{ Hz}, t_p = 10 \text{ ms}$	1800 V	1600 V	1400 V
dV/dt_{crit}	Exp. to 1210 V, $T_{vj} = 125^\circ\text{C}$	1000 V/ μs		

Characteristic values

Parameter	Symbol	Conditions	min	typ	max	Unit
Forward leakage current	I_{DRM}	$V_{DRM}, T_{vj} = 125^\circ\text{C}$			200	mA
Reverse leakage current	I_{RRM}	$V_{RRM}, T_{vj} = 125^\circ\text{C}$			200	mA

Mechanical data

Maximum rated values ¹⁾

Parameter	Symbol	Conditions	min	typ	max	Unit
Mounting force	F_M		45	50	55	kN
Acceleration	a	Device unclamped			50	m/s^2
Acceleration	a	Device clamped			100	m/s^2

Characteristic values

Parameter	Symbol	Conditions	min	typ	max	Unit
Weight	m				0.93	kg
Surface creepage distance	D_S		36			mm
Air strike distance	D_a		15			mm

¹⁾ Maximum rated values indicate limits beyond which damage to the device may occur

ABB Switzerland Ltd, Semiconductors reserves the right to change specifications without notice.



On-state

Maximum rated values ¹⁾

Parameter	Symbol	Conditions	min	typ	max	Unit
Average on-state current	$I_{T(AV)M}$	Half sine wave, $T_c = 70^\circ\text{C}$			3108	A
RMS on-state current	$I_{T(RMS)}$				4882	A
Peak non-repetitive surge current	I_{TSM}	$t_p = 10\text{ ms}$, $T_{vj} = 125^\circ\text{C}$, $V_D = V_R = 0\text{ V}$			47×10^3	A
Limiting load integral	I^2t				11.05×10^6	A^2s
Peak non-repetitive surge current	I_{TSM}	$t_p = 8.3\text{ ms}$, $T_{vj} = 125^\circ\text{C}$, $V_D = V_R = 0\text{ V}$			50.2×10^3	A
Limiting load integral	I^2t				10.46×10^6	A^2s

Characteristic values

Parameter	Symbol	Conditions	min	typ	max	Unit
On-state voltage	V_T	$I_T = 4000\text{ A}$, $T_{vj} = 125^\circ\text{C}$			1.3	V
Threshold voltage	$V_{(T0)}$	$I_T = 4000\text{ A} - 11500\text{ A}$, $T_{vj} = 125^\circ\text{C}$			0.984	V
Slope resistance	r_T				0.081	$\text{m}\Omega$
Holding current	I_H	$T_{vj} = 25^\circ\text{C}$		170		mA
		$T_{vj} = 125^\circ\text{C}$		90		mA
Latching current	I_L	$T_{vj} = 25^\circ\text{C}$		1500		mA
		$T_{vj} = 125^\circ\text{C}$		1000		mA

Switching

Maximum rated values ¹⁾

Parameter	Symbol	Conditions	min	typ	max	Unit
Critical rate of rise of on-state current	di/dt_{crit}	$T_{vj} = 125^\circ\text{C}$, $I_{TRM} = \text{A}$, Cont. $f = 50\text{ Hz}$			200	$\text{A}/\mu\text{s}$
Critical rate of rise of on-state current	di/dt_{crit}	$V_D \leq 1880\text{ V}$, $I_{FG} = 2\text{ A}$, $t_r = 0.3\ \mu\text{s}$ Cont. $f = 1\text{ Hz}$			1000	$\text{A}/\mu\text{s}$
Circuit-commutated turn-off time	t_q	$T_{vj} = 125^\circ\text{C}$, $I_{TRM} = 4000\text{ A}$, $V_R = 100\text{ V}$, $di_T/dt = -12.5\text{ A}/\mu\text{s}$, $V_D \leq 0.67 \cdot V_{DRM}$, $dv_D/dt = 50\text{ V}/\mu\text{s}$		200		μs

Characteristic values

Parameter	Symbol	Conditions	min	typ	max	Unit
Recovery charge	Q_{rr}	$T_{vj} = 125^\circ\text{C}$, $I_{TRM} = 4000\text{ A}$, $V_R = 100\text{ V}$, $di_T/dt = -12.5\text{ A}/\mu\text{s}$		2800		μAs
Gate turn-on delay time	t_{gd}	$V_D = 0.4 \cdot V_{RM}$, $I_{FG} = 2\text{ A}$, $t_r = 0.3\ \mu\text{s}$, $T_{vj} = 25^\circ\text{C}$			2	μs

Triggering

Maximum rated values ¹⁾

Parameter	Symbol	Conditions	min	typ	max	Unit
Peak forward gate voltage	V_{FGM}				12	V
Peak forward gate current	I_{FGM}				10	A
Peak reverse gate voltage	V_{RGM}				10	V
Mean forward gate power	$P_{G(AV)}$				5	W

Characteristic values

Parameter	Symbol	Conditions	min	typ	max	Unit
Gate-trigger voltage	V_{GT}	$T_{vj} = -40\text{ °C}$			4	V
		$T_{vj} = 25\text{ °C}$			3	
		$T_{vj} = 125\text{ °C}$	0.25		2	
Gate-trigger current	I_{GT}	$T_{vj} = -40\text{ °C}$			500	mA
		$T_{vj} = 25\text{ °C}$			250	
		$T_{vj} = 125\text{ °C}$	10		150	

Thermal

Maximum rated values ¹⁾

Parameter	Symbol	Conditions	min	typ	max	Unit
Operating junction temperature range	T_{vj}		-40		125	°C
Storage temperature range	T_{stg}		-40		125	°C

Characteristic values

Parameter	Symbol	Conditions	min	typ	max	Unit
Thermal resistance junction to case	$R_{th(j-c)}$	Double-side cooled $F_m = 45...55\text{ kN}$			10	K/kW
	$R_{th(j-c)A}$	Anode-side cooled $F_m = 45...55\text{ kN}$			16	K/kW
	$R_{th(j-c)C}$	Cathode-side cooled $F_m = 45...55\text{ kN}$			26.5	K/kW
Thermal resistance case to heatsink	$R_{th(c-h)}$	Double-side cooled $F_m = 45...55\text{ kN}$			3	K/kW
	$R_{th(c-h)}$	Single-side cooled $F_m = 45...55\text{ kN}$			6	K/kW

Analytical function for transient thermal impedance:

$$Z_{th(j-c)}(t) = \sum_{i=1}^n R_{th i} (1 - e^{-t/t_i})$$

i	1	2	3	4
$R_{th i}(\text{K/kW})$	6.730	1.440	0.650	1.160
$\tau_i(\text{s})$	0.4871	0.1468	0.0677	0.0079

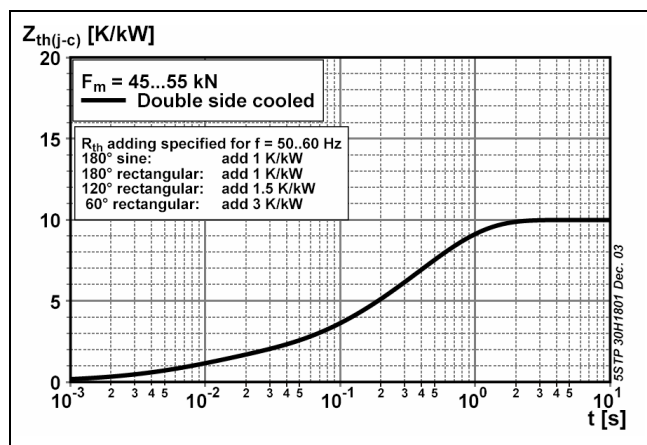

Fig. 1 Transient thermal impedance junction-to case.

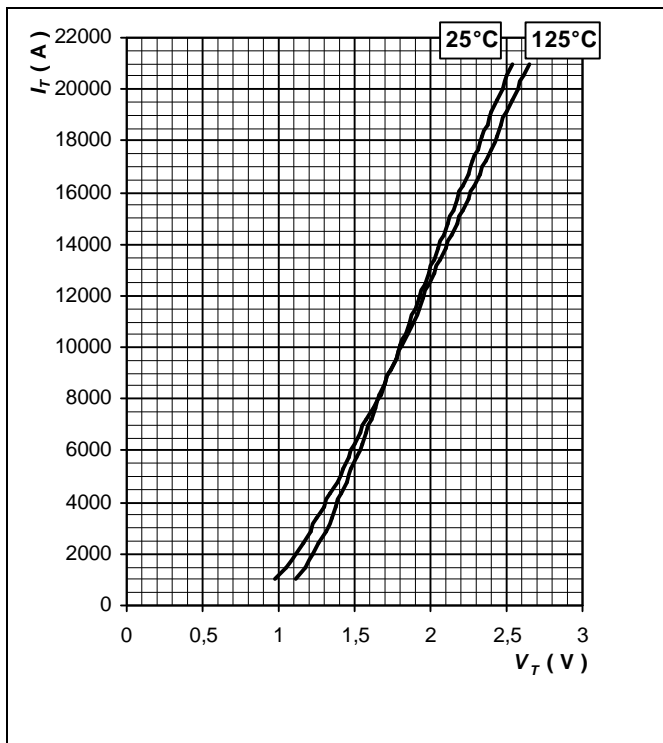

Fig. 2 Max. on-state voltage characteristics

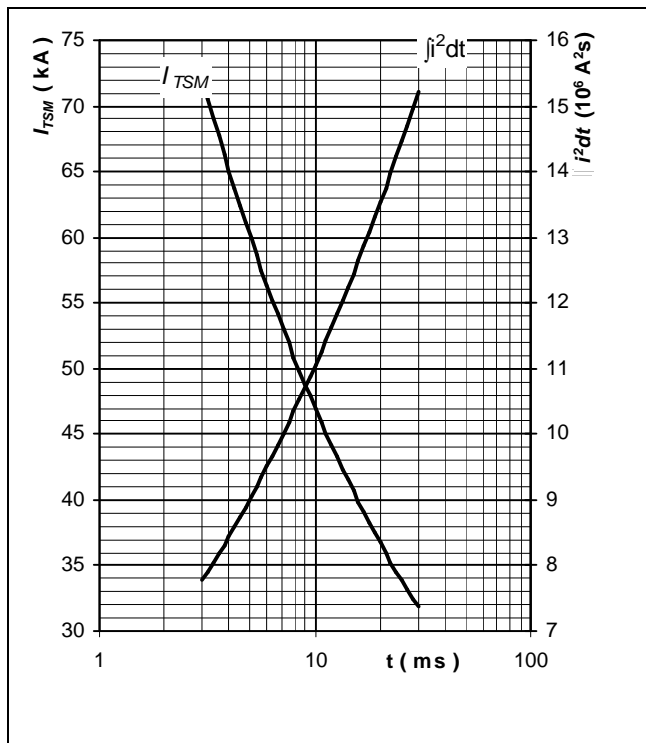

Fig. 3 Surge forward current vs. pulse length. Half sine wave, single pulse, $V_R = 0$ V

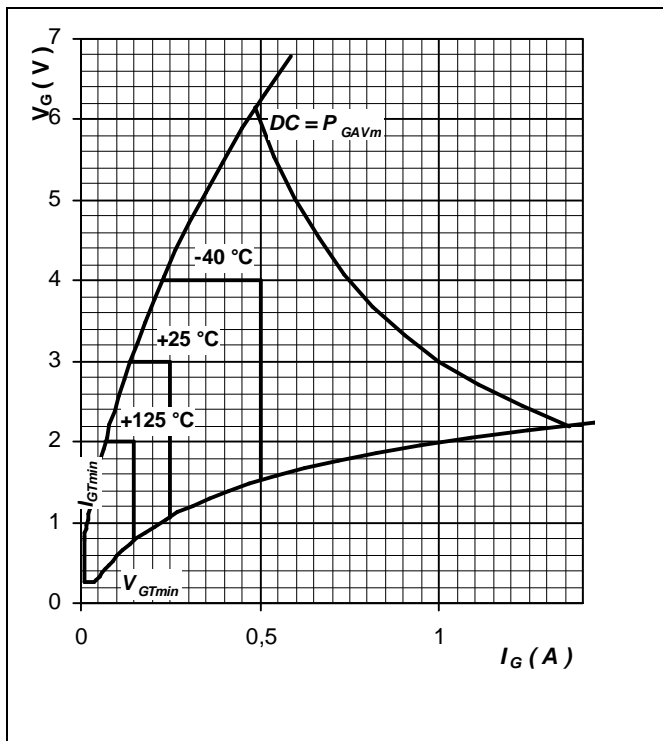

Fig. 4 Gate trigger characteristics

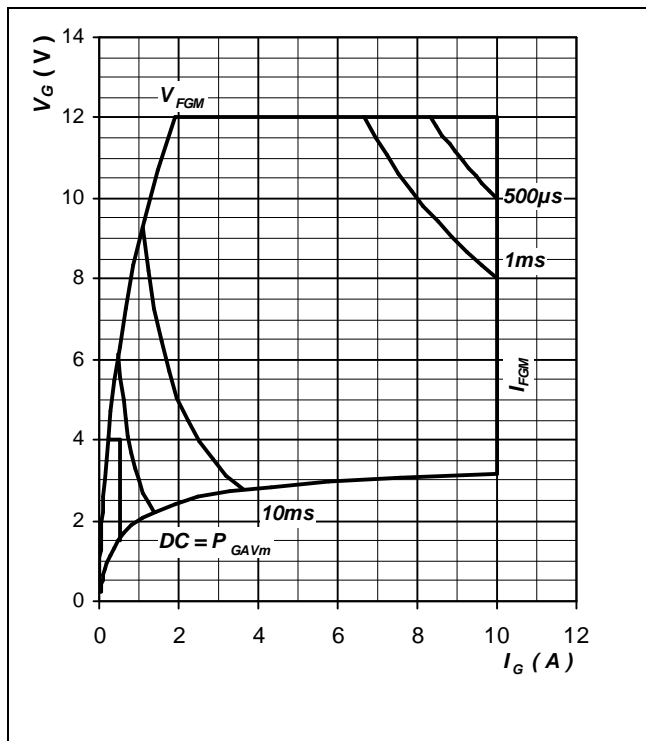

Fig. 5 Gate trigger characteristics

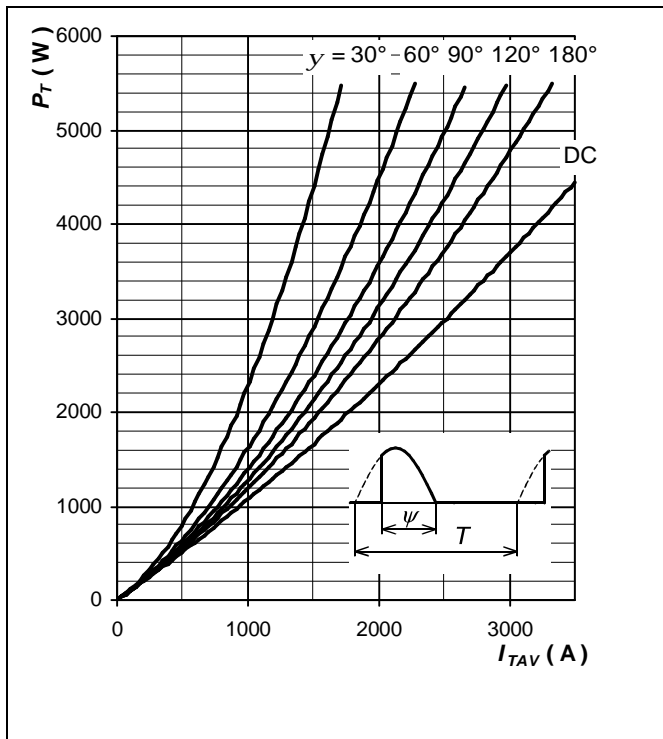

Fig. 6 Forward power loss vs. average forward current, sine waveform, $f = 50 \text{ Hz}$, $T = 1/f$

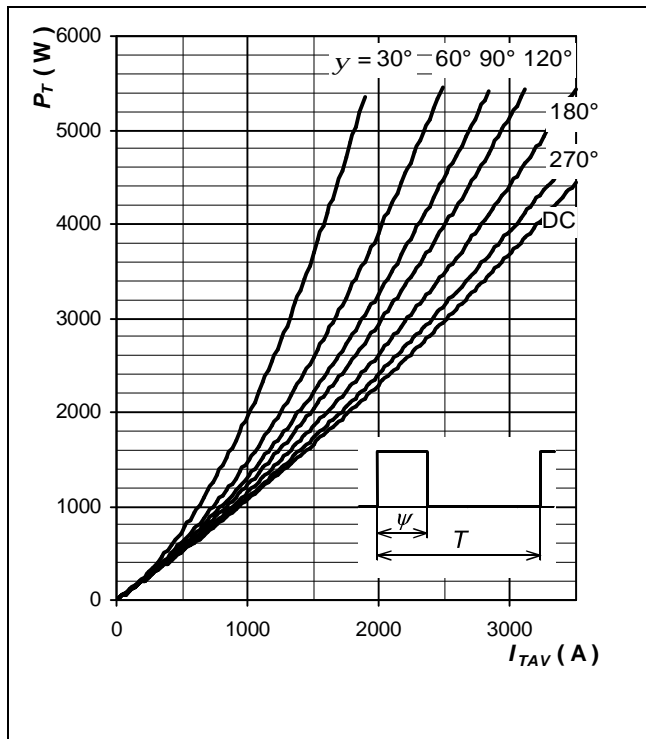

Fig. 7 Forward power loss vs. average forward current, square waveform, $f = 50 \text{ Hz}$, $T = 1/f$

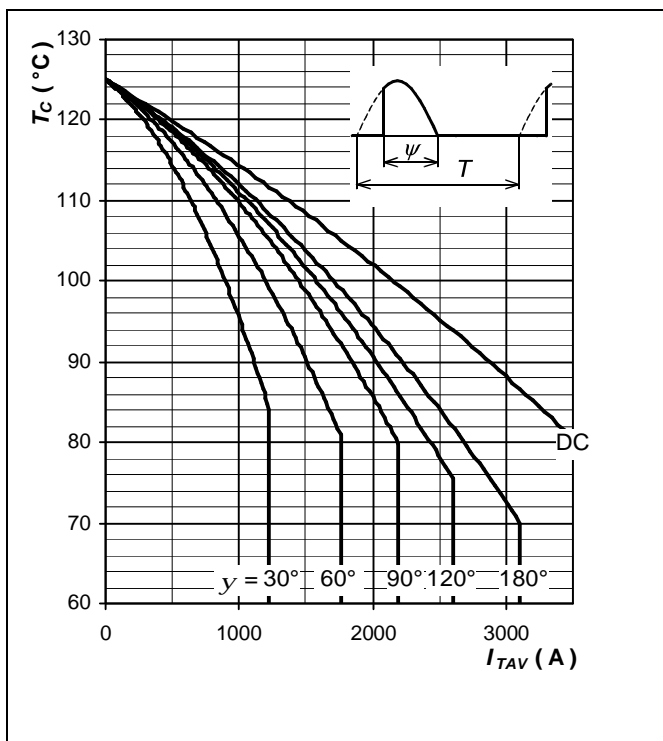

Fig. 8 Max. case temperature vs. average forward current, sine waveform, $f = 50 \text{ Hz}$, $T = 1/f$

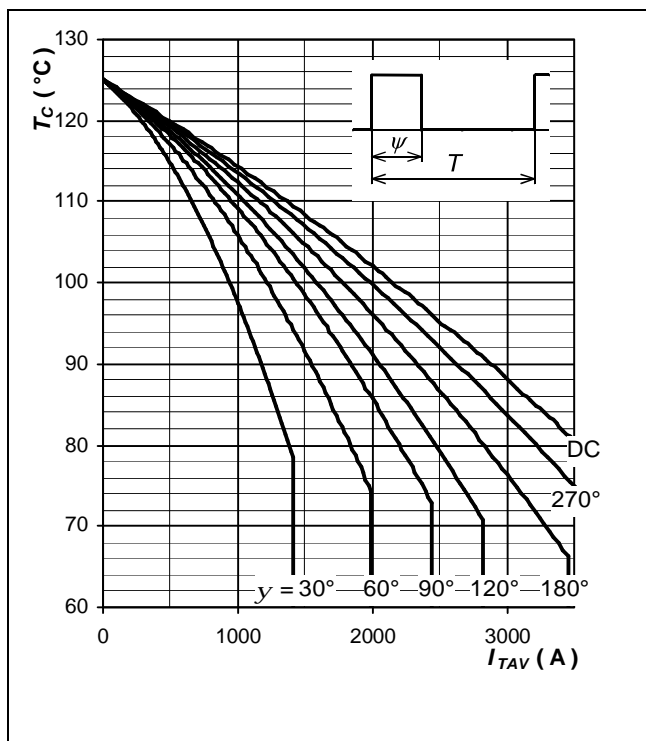

Fig. 9 Max. case temperature vs. average forward current, square waveform, $f = 50 \text{ Hz}$, $T = 1/f$

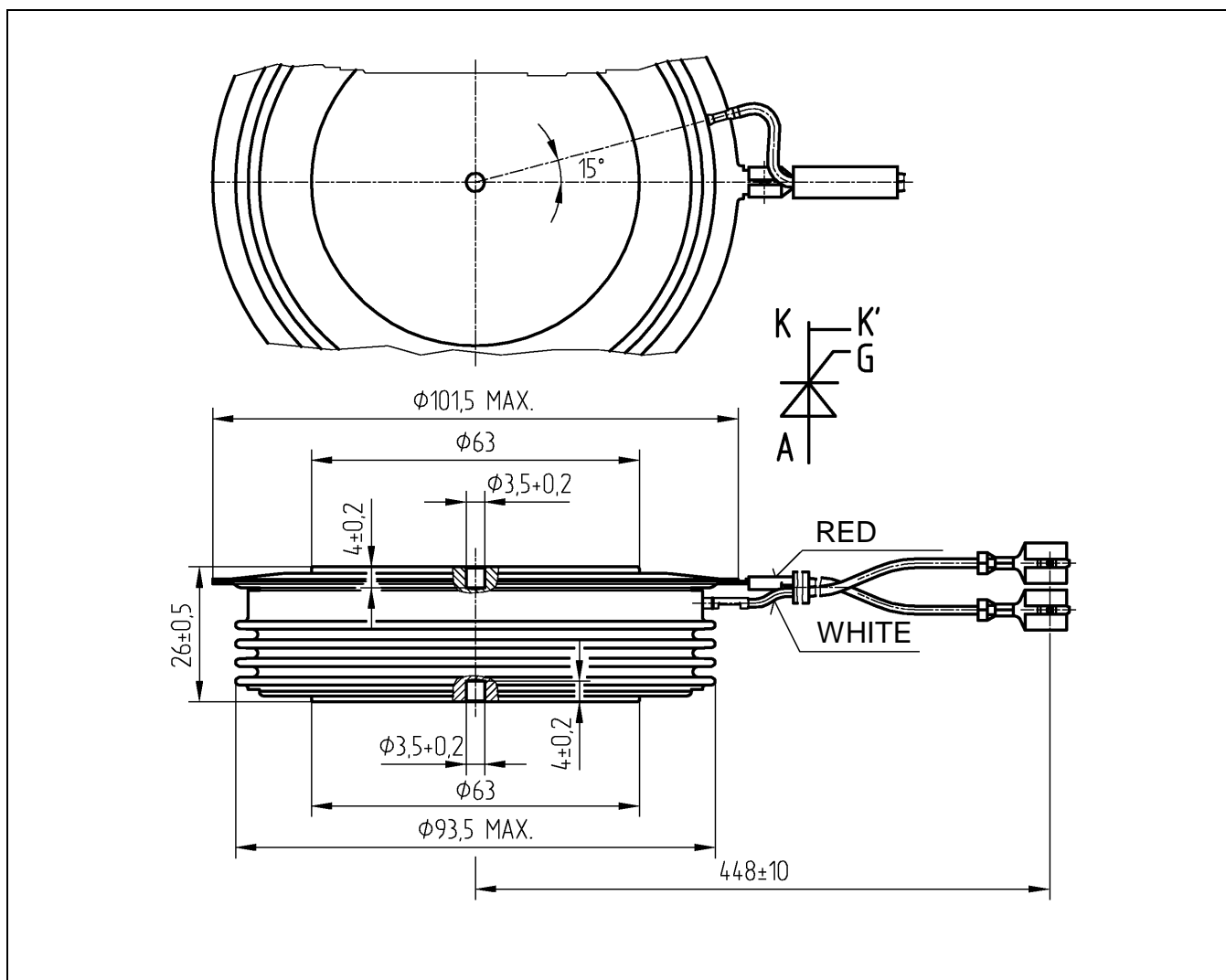

Fig. 10 Device Outline Drawing.

Related application notes:

Doc. Nr	Titel
5SYA2020	Design of RC-Snubber for Phase Control Applications
5SYA2034	Gate-drive Recommendations for PCT's
5SYA 2036	Recommendations regarding mechanical clamping of Press Pack High Power Semiconductors

Please refer to <http://www.abb.com/semiconductors> for actual versions.

ABB Switzerland Ltd, Semiconductors reserves the right to change specifications without notice.



ABB Switzerland Ltd
Semiconductors
Fabrikstrasse 3
CH-5600 Lenzburg, Switzerland

Doc. No. 5SYA1066-01 March 05

Telephone +41 (0)58 586 1419
Fax +41 (0)58 586 1306
Email abbsem@ch.abb.com
Internet www.abb.com/semiconductors