

$V_{DRM}$	=	2800 V
$I_{T(AV)M}$	=	5490 A
$I_{T(RMS)}$	=	8625 A
$I_{TSM}$	=	$75 \times 10^3$ A
$V_{T0}$	=	0.86 V
$r_T$	=	0.07 mW

# Phase Control Thyristor

## 5STP 45Q2800

Doc. No. 5SYA1050-02 May 07

- Patented free-floating silicon technology
- Low on-state and switching losses
- Designed for traction, energy and industrial applications
- Optimum power handling capability
- Interdigitated amplifying gate

### Blocking

*Maximum rated values* <sup>1)</sup>

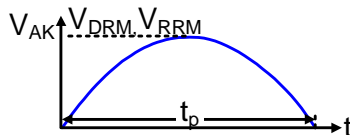
Parameter	Symbol	Conditions	5STP 45Q2800	Unit
Max repetitive peak forward and reverse blocking voltage	$V_{DRM}$ , $V_{RRM}$	$f = 50$ Hz, $t_p = 10$ ms, $T_{vj} = 5 \dots 125^\circ\text{C}$ , Note 1	2800	V
				
Critical rate of rise of commutating voltage	$dv/dt_{crit}$	Exp. to 1880 V, $T_{vj} = 125^\circ\text{C}$	1000	V/ $\mu\text{s}$

*Characteristic values*

Parameter	Symbol	Conditions	min	typ	max	Unit
Forward leakage current	$I_{DRM}$	$V_{DRM}$ , $T_{vj} = 125^\circ\text{C}$			400	mA
Reverse leakage current	$I_{RRM}$	$V_{RRM}$ , $T_{vj} = 125^\circ\text{C}$			400	mA

Note 1: Voltage de-rating factor of 0.11% per °C is applicable for  $T_{vj}$  below +5 °C

### Mechanical data

*Maximum rated values* <sup>1)</sup>

Parameter	Symbol	Conditions	min	typ	max	Unit
Mounting force	$F_M$		81	90	108	kN
Acceleration	a	Device unclamped			50	$\text{m/s}^2$
Acceleration	a	Device clamped			100	$\text{m/s}^2$

*Characteristic values*

Parameter	Symbol	Conditions	min	typ	max	Unit
Weight	m				2.1	kg
Housing thickness	H	$F_M = 90$ kN, $T_a = 25^\circ\text{C}$	25.8		26.4	mm
Surface creepage distance	$D_S$		36			mm
Air strike distance	$D_a$		15			mm

1) Maximum rated values indicate limits beyond which damage to the device may occur

ABB Switzerland Ltd, Semiconductors reserves the right to change specifications without notice.



## On-state

### Maximum rated values <sup>1)</sup>

Parameter	Symbol	Conditions	min	typ	max	Unit
Average on-state current	$I_{T(AV)M}$	Half sine wave, $T_c = 70\text{ °C}$			5490	A
RMS on-state current	$I_{T(RMS)}$				8625	A
Peak non-repetitive surge current	$I_{TSM}$	$t_p = 10\text{ ms}$ , $T_{vj} = 125\text{ °C}$ , sine wave after surge: $V_D = V_R = 0\text{ V}$			$75 \times 10^3$	A
Limiting load integral	$I^2t$				$28.1 \times 10^6$	$A^2s$
Peak non-repetitive surge current	$I_{TSM}$	$t_p = 8.3\text{ ms}$ , $T_{vj} = 125\text{ °C}$ , sine wave after surge: $V_D = V_R = 0\text{ V}$			$79 \times 10^3$	A
Limiting load integral	$I^2t$				$25.9 \times 10^6$	$A^2s$

### Characteristic values

Parameter	Symbol	Conditions	min	typ	max	Unit
On-state voltage	$V_T$	$I_T = 3000\text{ A}$ , $T_{vj} = 125\text{ °C}$			1.07	V
Threshold voltage	$V_{(T0)}$	$I_T = 3000\text{ A} - 9000\text{ A}$ , $T_{vj} = 125\text{ °C}$			0.86	V
Slope resistance	$r_T$				0.07	$m\Omega$
Holding current	$I_H$	$T_{vj} = 25\text{ °C}$			100	mA
		$T_{vj} = 125\text{ °C}$			75	mA
Latching current	$I_L$	$T_{vj} = 25\text{ °C}$			500	mA
		$T_{vj} = 125\text{ °C}$			350	mA

## Switching

### Maximum rated values <sup>1)</sup>

Parameter	Symbol	Conditions	min	typ	max	Unit
Critical rate of rise of on-state current	$di/dt_{crit}$	$T_{vj} = 125\text{ °C}$ , $I_{TRM} = 3000\text{ A}$ , Cont. $f = 50\text{ Hz}$			250	$A/\mu s$
Critical rate of rise of on-state current	$di/dt_{crit}$	$V_D \leq 1210\text{ V}$ , $I_{FG} = 2\text{ A}$ , $t_r = 0.5\text{ }\mu s$ Cont. $f = 1\text{ Hz}$			1000	$A/\mu s$
Circuit-commutated turn-off time	$t_q$	$T_{vj} = 125\text{ °C}$ , $I_{TRM} = 2000\text{ A}$ , $V_R = 200\text{ V}$ , $di_T/dt = -1.5\text{ A}/\mu s$ , $V_D \leq 0.67 \cdot V_{DRM}$ , $dV_D/dt = 20\text{ V}/\mu s$	400			$\mu s$

### Characteristic values

Parameter	Symbol	Conditions	min	typ	max	Unit
Reverse recovery charge	$Q_{rr}$	$T_{vj} = 125\text{ °C}$ , $I_{TRM} = 2000\text{ A}$ , $V_R = 200\text{ V}$ , $di_T/dt = -1.5\text{ A}/\mu s$	1200		3800	$\mu As$
Reverse recovery current	$I_{RM}$		30		100	A
Gate turn-on delay time	$t_{gd}$	$T_{vj} = 25\text{ °C}$ , $V_D = 0.4 \cdot V_{RM}$ , $I_{FG} = 2\text{ A}$ , $t_r = 0.5\text{ }\mu s$			3	$\mu s$

## Triggering

Maximum rated values <sup>1)</sup>

Parameter	Symbol	Conditions	min	typ	max	Unit
Peak forward gate voltage	$V_{FGM}$				12	V
Peak forward gate current	$I_{FGM}$				10	A
Peak reverse gate voltage	$V_{RGM}$				10	V
Average gate power loss	$P_{G(AV)}$		see Fig. 9			W

Characteristic values

Parameter	Symbol	Conditions	min	typ	max	Unit
Gate-trigger voltage	$V_{GT}$	$T_{vj} = 25\text{ °C}$			2.6	V
Gate-trigger current	$I_{GT}$	$T_{vj} = 25\text{ °C}$			400	mA
Gate non-trigger voltage	$V_{GD}$	$V_D = 0.4 \times V_{DRM}, T_{vj} = 125\text{ °C}$	0.3			V
Gate non-trigger current	$I_{GD}$	$V_D = 0.4 \times V_{DRM}, T_{vj} = 125\text{ °C}$	10			mA

## Thermal

Maximum rated values <sup>1)</sup>

Parameter	Symbol	Conditions	min	typ	max	Unit
Operating junction temperature range	$T_{vj}$				125	°C
Storage temperature range	$T_{stg}$		-40		140	°C

Characteristic values

Parameter	Symbol	Conditions	min	typ	max	Unit
Thermal resistance junction to case	$R_{th(j-c)}$	Double-side cooled $F_m = 81...108\text{ kN}$			5	K/kW
	$R_{th(j-c)A}$	Anode-side cooled $F_m = 81...108\text{ kN}$			10	K/kW
	$R_{th(j-c)C}$	Cathode-side cooled $F_m = 81...108\text{ kN}$			10	K/kW
Thermal resistance case to heatsink	$R_{th(c-h)}$	Double-side cooled $F_m = 81...108\text{ kN}$			1	K/kW
	$R_{th(c-h)}$	Single-side cooled $F_m = 81...108\text{ kN}$			2	K/kW

Analytical function for transient thermal impedance:

$$Z_{th(j-c)}(t) = \sum_{i=1}^n R_i (1 - e^{-t/\tau_i})$$

i	1	2	3	4
$R_i$ (K/kW)	3.560	0.680	0.460	0.280
$\tau_i$ (s)	0.4069	0.0559	0.0075	0.0018

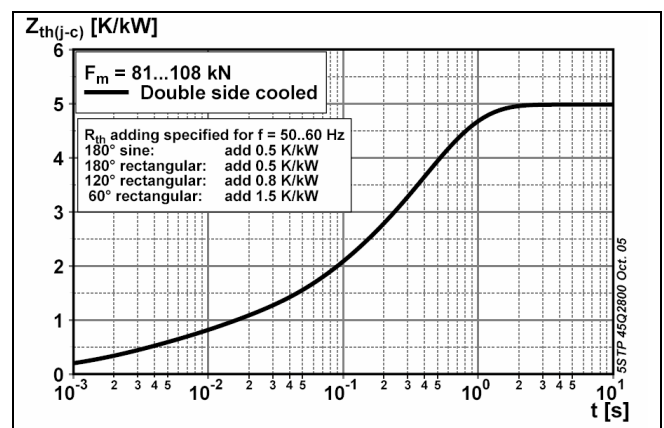

Fig. 1 Transient thermal impedance (junction-to-case) vs. time

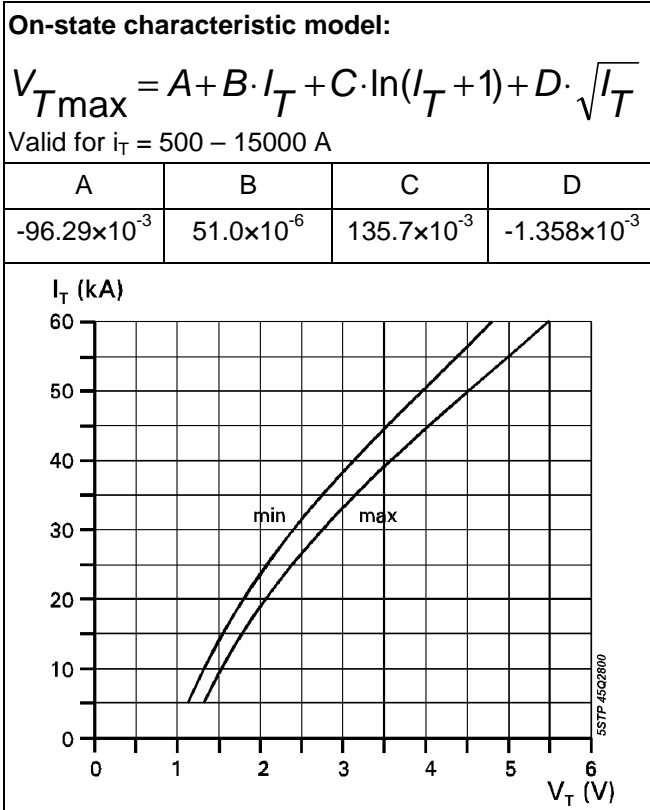

Fig. 2 On-state characteristics

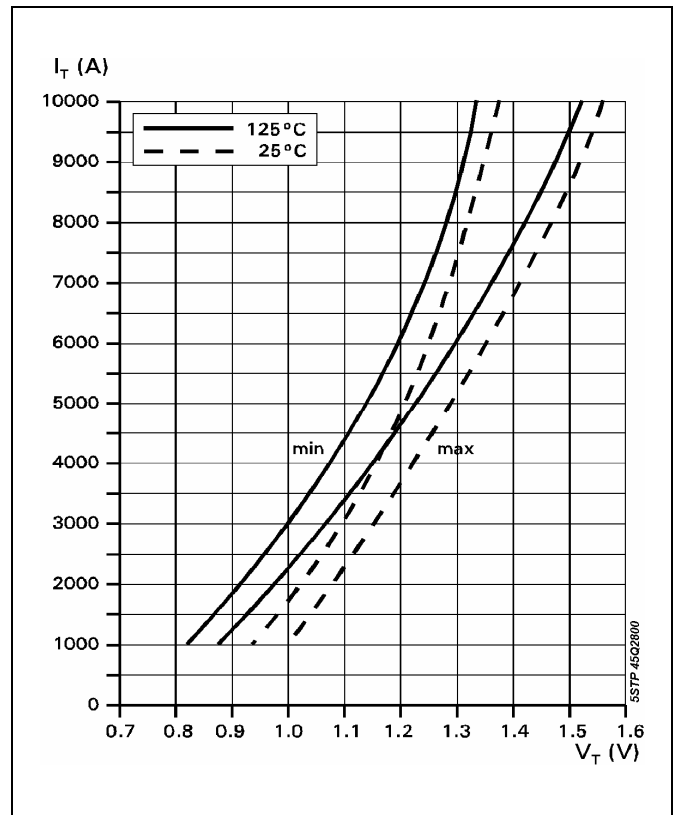

Fig. 3 On-state characteristics,  $T_j = 125^\circ\text{C}$ , 10ms half sine

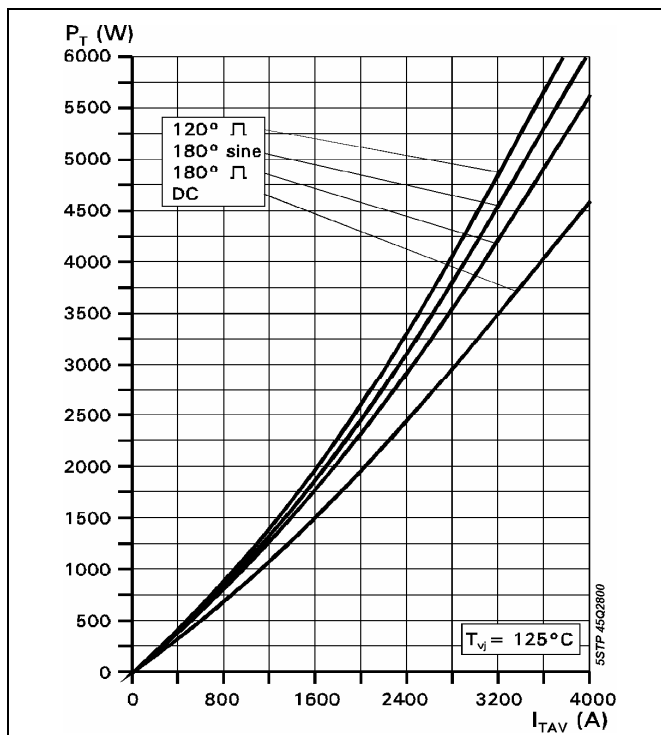

Fig. 4 On-state power dissipation vs. mean on-state current, turn-on losses excluded

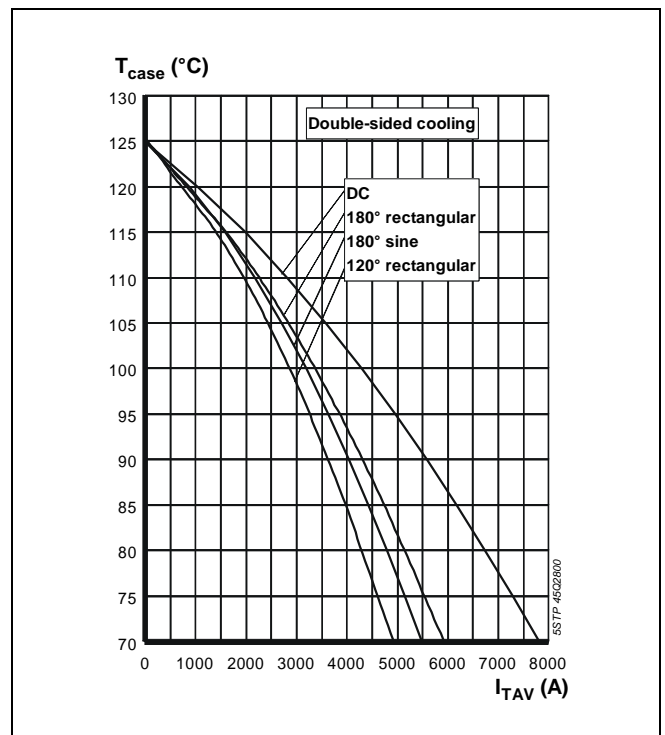
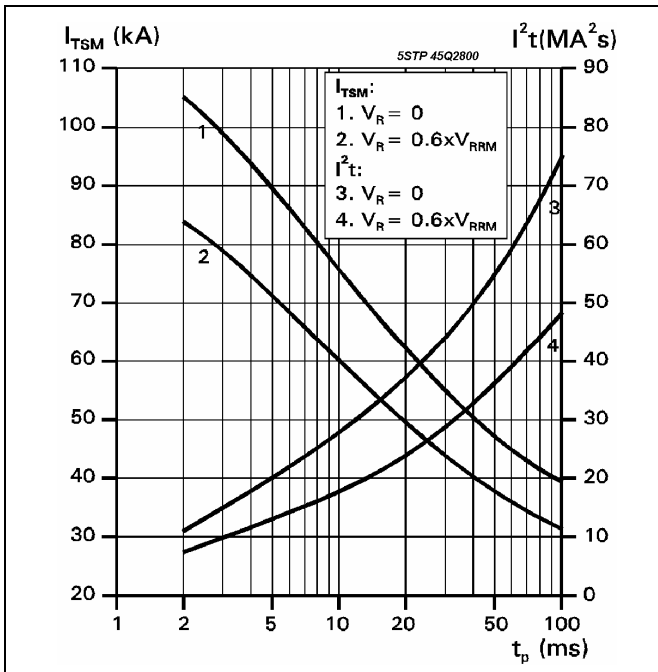
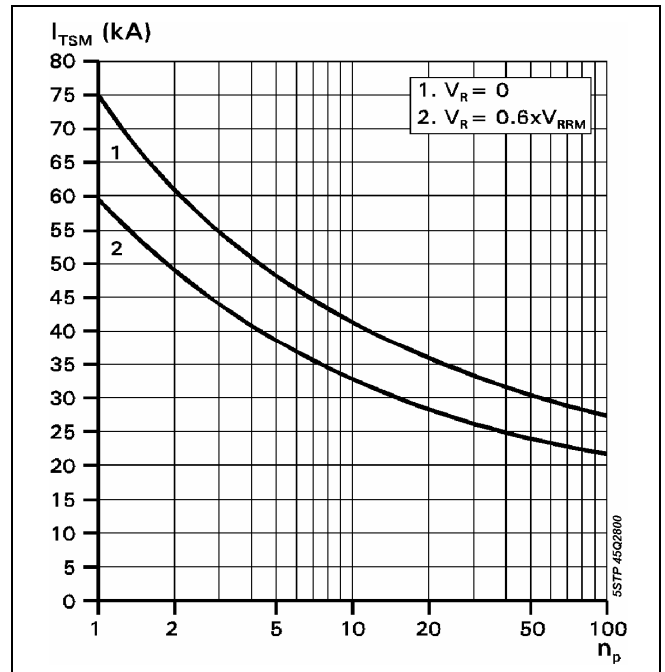

Fig. 5 Max. permissible case temperature vs. mean on-state current, switching losses ignored



**Fig. 6** Surge on-state current vs. pulse length, half-sine wave



**Fig. 7** Surge on-state current vs. number of pulses, half-sine wave, 10 ms, 50Hz

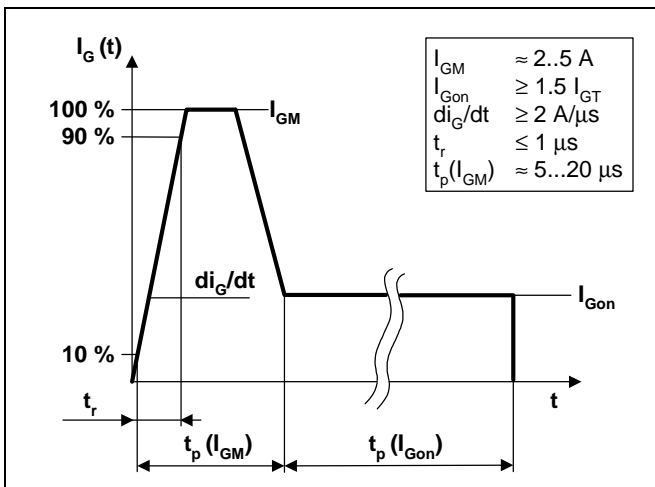

**Fig. 8** Recommended gate current waveform

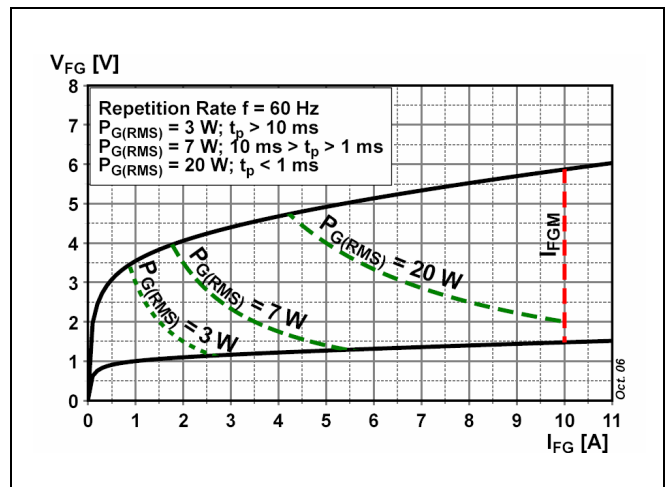

**Fig. 9** Max. peak gate power loss

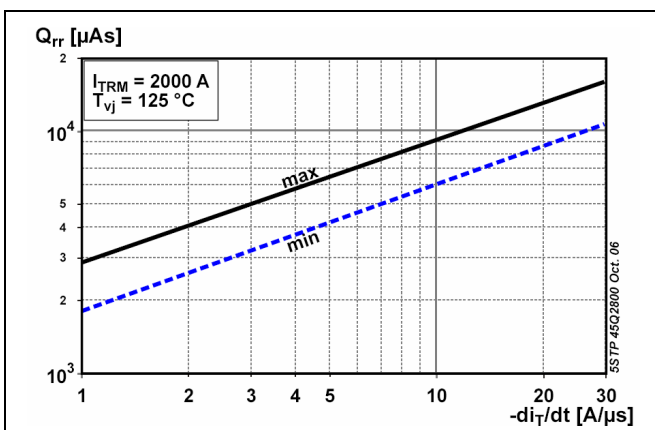

**Fig. 10** Reverse recovery charge vs. decay rate of on-state current

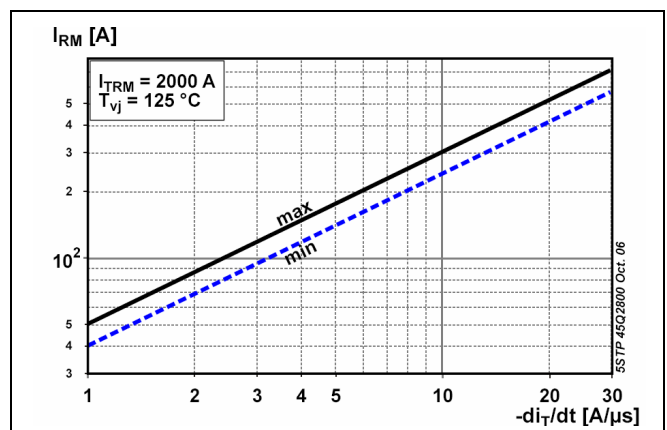

**Fig. 11** Peak reverse recovery current vs. decay rate of on-state current

# Turn-on and Turn-off losses

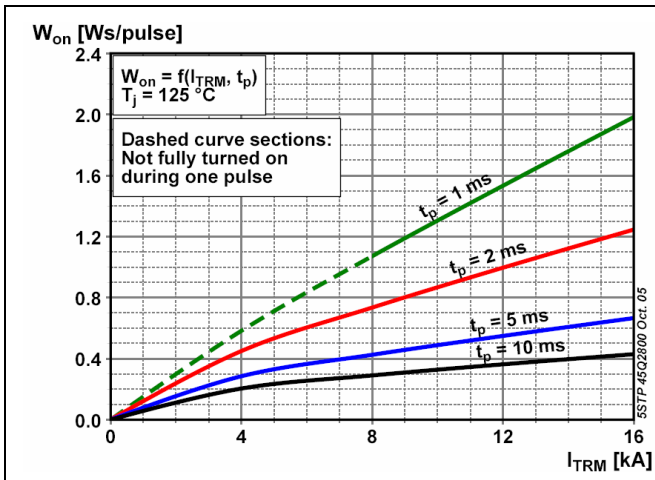

Fig. 12 Turn-on energy, half sinusoidal waves

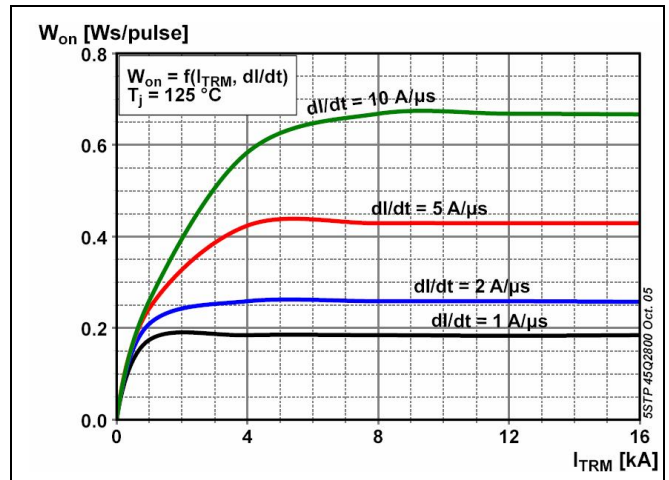

Fig. 13 Turn-on energy, rectangular waves

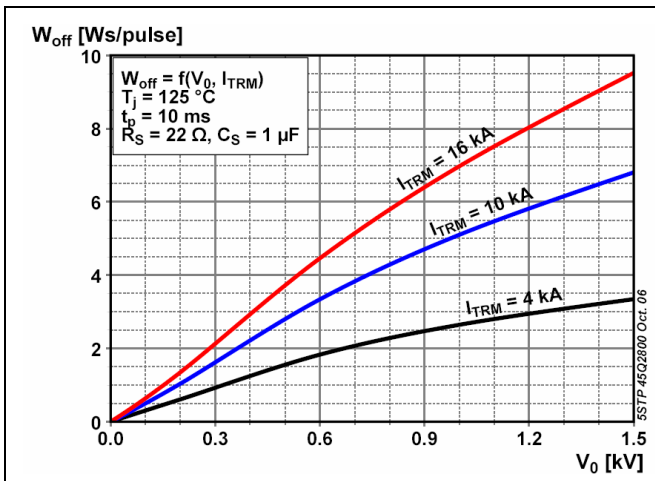

Fig. 14 Turn-off energy, half sinusoidal waves

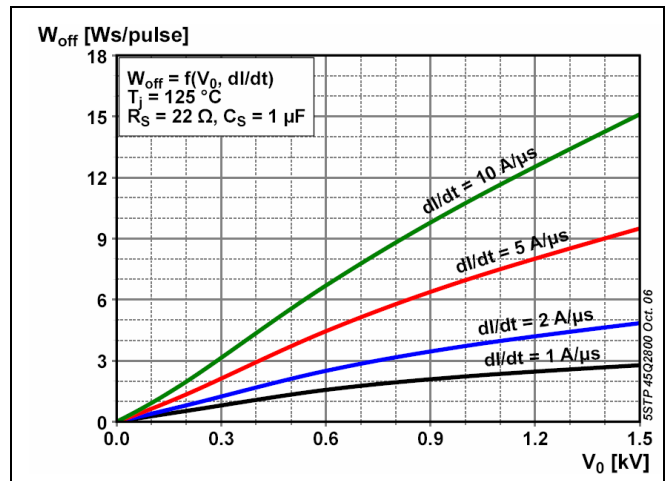

Fig. 15 Turn-off energy, rectangular waves

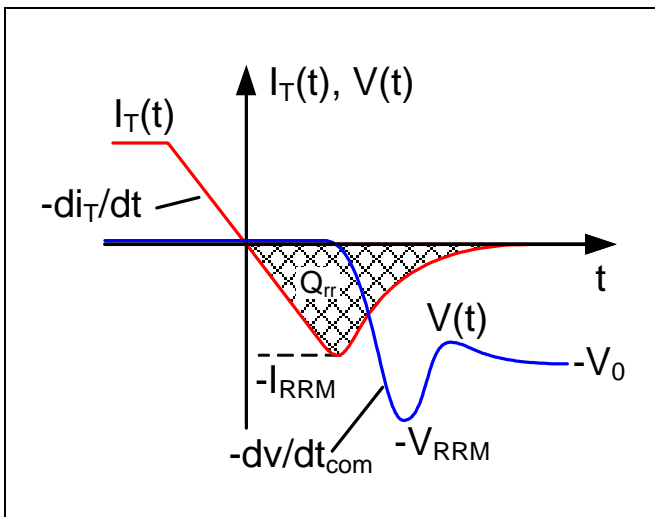

Fig. 16 Current and voltage waveforms at turn-off

**Total power loss for repetitive waveforms:**

$$P_{TOT} = P_T + W_{on} \cdot f + W_{off} \cdot f$$

where

$$P_T = \frac{1}{T} \int_0^T I_T \cdot V_T(I_T) dt$$

Fig. 17 Relationships for power loss

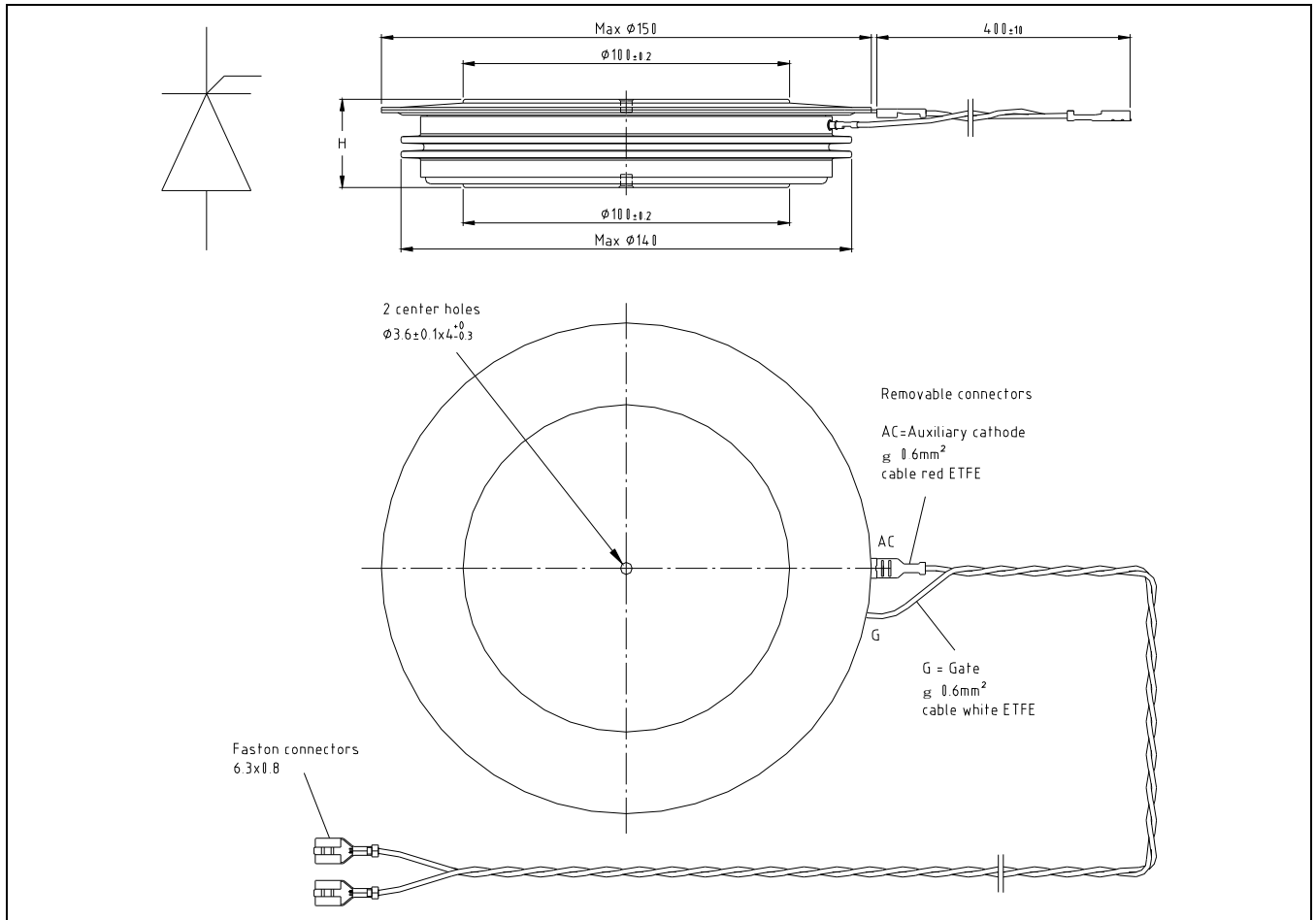

**Fig. 18** Device Outline Drawing

### Related documents:

5SYA 2020	Design of RC-Snubber for Phase Control Applications
5SYA 2049	Voltage definitions for phase control thyristors and diodes
5SYA 2051	Voltage ratings of high power semiconductors
5SYA 2034	Gate-Drive Recommendations for PCT's
5SYA 2036	Recommendations regarding mechanical clamping of Press Pack High Power Semiconductors
5SZK 9104	Specification of environmental class for pressure contact diodes, PCTs and GTO, STORAGE available on request, please contact factory
5SZK 9105	Specification of environmental class for pressure contact diodes, PCTs and GTO, TRANSPORTATION available on request, please contact factory

Please refer to <http://www.abb.com/semiconductors> for current version of documents.

**ABB Switzerland Ltd, Semiconductors reserves the right to change specifications without notice.**



**ABB Switzerland Ltd**  
**Semiconductors**  
 Fabrikstrasse 3  
 CH-5600 Lenzburg, Switzerland

Doc. No. 5SYA1050-02 May 07

Telephone +41 (0)58 586 1419  
 Fax +41 (0)58 586 1306  
 Email [abbsem@ch.abb.com](mailto:abbsem@ch.abb.com)  
 Internet [www.abb.com/semiconductors](http://www.abb.com/semiconductors)