

# 6MBP100RA060

## IGBT-IPM R series

600V / 100A 6 in one-package

### Features

- Temperature protection provided by directly detecting the junction temperature of the IGBTs
- Low power loss and soft switching
- High performance and high reliability IGBT with overheating protection
- Higher reliability because of a big decrease in number of parts in built-in control circuit

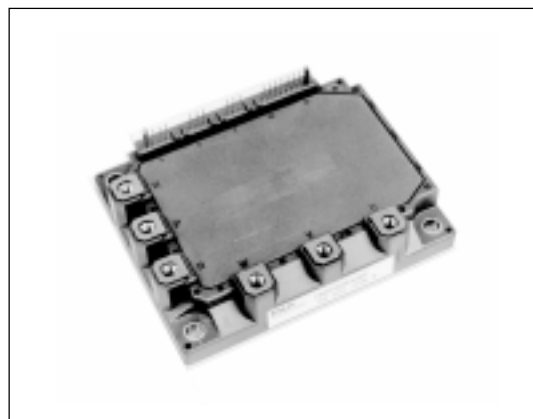

### Maximum ratings and characteristics

- Absolute maximum ratings(at  $T_c=25^\circ\text{C}$  unless otherwise specified)

Item	Symbol	Rating		Unit		
		Min.	Max.			
DC bus voltage	V <sub>DC</sub>	0	450	V		
DC bus voltage (surge)	V <sub>DC(surge)</sub>	0	500	V		
DC bus voltage (short operating)	V <sub>SC</sub>	200	400	V		
Collector-Emitter voltage	V <sub>CES</sub>	0	600	V		
INV	Collector current	DC	I <sub>C</sub>	-	100	A
		1ms	I <sub>CP</sub>	-	200	A
		Duty=59.5%	-I <sub>C</sub>	-	100	A
	Collector power dissipation	One transistor	P <sub>C</sub>	-	400	W
Junction temperature	T <sub>j</sub>	-	150	°C		
Input voltage of power supply for Pre-Driver	V <sub>CC</sub> *1	0	20	V		
Input signal voltage	V <sub>in</sub> *2	0	V <sub>Z</sub>	V		
Input signal current	I <sub>in</sub>	-	1	mA		
Alarm signal voltage	V <sub>ALM</sub> *3	0	V <sub>CC</sub>	V		
Alarm signal current	I <sub>ALM</sub> *4	-	15	mA		
Storage temperature	T <sub>stg</sub>	-40	125	°C		
Operating case temperature	T <sub>op</sub>	-20	100	°C		
Isolating voltage (Case-Terminal)	V <sub>iso</sub> *5	-	AC2.5	kV		
Screw torque	Mounting (M5)	-	3.5 *6	N·m		
	Terminal (M5)	-	3.5 *6	N·m		

\*1 Apply V<sub>CC</sub> between terminal No. 3 and 1, 6 and 4, 9 and 7, 11 and 10.

\*2 Apply V<sub>in</sub> between terminal No. 2 and 1, 5 and 4, 8 and 7, 13,14,15 and 10.

\*3 Apply V<sub>ALM</sub> between terminal No. 16 and 10.

\*4 Apply I<sub>ALM</sub> to terminal No. 16.

\*5 50Hz/60Hz sine wave 1 minute.

\*6 Recommendable Value : 2.5 to 3.0 N·m

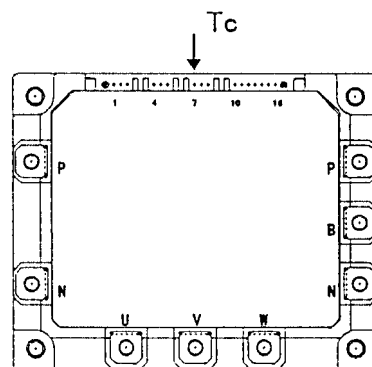

Fig.1 Measurement of case temperature

- Electrical characteristics of power circuit (at  $T_c=T_j=25^\circ\text{C}$ ,  $V_{CC}=15\text{V}$ )

Item	Symbol	Condition	Min.	Typ.	Max.	Unit	
INV	Collector current at off signal input	I <sub>CES</sub>	V <sub>CE</sub> =600V input terminal open	-	-	1.0	mA
	Collector-Emitter saturation voltage	V <sub>CE(sat)</sub>	I <sub>C</sub> =100A	-	-	2.8	V
	Forward voltage of FWD	V <sub>F</sub>	-I <sub>C</sub> =100A	-	-	3.0	V

● Electrical characteristics of control circuit(at  $T_c=T_j=25^{\circ}\text{C}$ ,  $V_{cc}=15\text{V}$ )

Item	Symbol	Condition	Min.	Typ.	Max.	Unit	
Power supply current of P-line side Pre-driver(one unit)	$I_{ccp}$	$fsw=0$ to 15kHz $T_c=-20$ to $100^{\circ}\text{C}$ *7	3	-	18	mA	
Power supply current of N-line side three Pre-driver	$I_{ccn}$	$fsw=0$ to 15kHz $T_c=-20$ to $100^{\circ}\text{C}$ *7	10	-	65	mA	
Input signal threshold voltage (on/off)	$V_{in(th)}$	ON	1.00	1.35	1.70	V	
		OFF	1.25	1.60	1.95	V	
Input zener voltage	$V_z$	$R_{in}=20\text{k ohm}$	-	8.0	-	V	
Over heating protection temperature level	$T_{COH}$	$V_{DC}=0\text{V}$ , $I_c=0\text{A}$ , Case temperature, Fig.1	110	-	125	$^{\circ}\text{C}$	
Hysteresis	$T_{CH}$		-	20	-	$^{\circ}\text{C}$	
IGBT chips over heating protection temperature level	$T_{JOH}$	surface of IGBT chips	150	-	-	$^{\circ}\text{C}$	
Hysteresis	$T_{jH}$		-	20	-	$^{\circ}\text{C}$	
Collector current protection level	INV	$I_{oc}$	$T_j=125^{\circ}\text{C}$	150	-	A	
Over current protection delay time		$t_{DOC}$	$T_j=25^{\circ}\text{C}$ Fig.2	-	10	$\mu\text{s}$	
Under voltage protection level		$V_{UV}$		11.0	-	12.5	V
Hysteresis		$V_H$		0.2	-	-	V
Alarm signal hold time		$t_{ALM}$		1.5	2	-	ms
SC protection delay time		$t_{SC}$	$T_j=25^{\circ}\text{C}$ Fig.3	-	-	12	$\mu\text{s}$
Limiting resistor for alarm		$R_{ALM}$		1425	1500	1575	ohm

\*7 Switching frequency of IPM

● Dynamic characteristics(at  $T_c=T_j=125^{\circ}\text{C}$ ,  $V_{cc}=15\text{V}$ )

Item	Symbol	Condition	Min.	Typ.	Max.	Unit
Switching time (IGBT)	$t_{on}$	$I_C=100\text{A}$ , $V_{DC}=300\text{V}$	0.3	-	-	$\mu\text{s}$
	$t_{off}$		-	-	3.6	$\mu\text{s}$
Switching time (FWD)	$t_{rr}$	$I_F=100\text{A}$ , $V_{DC}=300\text{V}$	-	-	0.4	$\mu\text{s}$

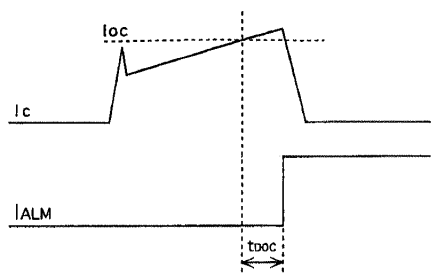

Fig.2 Definition of OC delay time

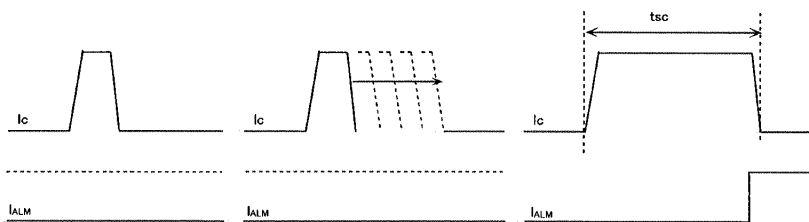

Fig.3 Definition of tsc

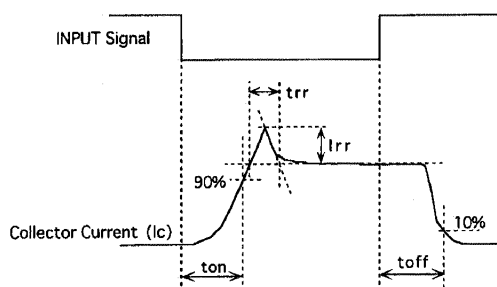

Fig.4 Definition of switching time

● Thermal characteristics(  $T_c=25^{\circ}\text{C}$ )

Item	Symbol	Typ.	Max.	Unit	
Junction to Case thermal resistance	INV				
	IGBT	$R_{th(j-c)}$	-	0.31	$^{\circ}\text{C/W}$
	FWD	$R_{th(j-c)}$	-	0.70	$^{\circ}\text{C/W}$
Case to fin thermal resistance with compound	$R_{th(c-f)}$	0.05	-	$^{\circ}\text{C/W}$	

● Recommendable value

Item	Symbol	Min.	Typ.	Max.	Unit	
DC bus voltage	$V_{DC}$	200	-	400	V	
Operating power supply voltage range of Pre-driver	$V_{CC}$	13.5	15	16.5	V	
Switching frequency of IPM	$fsw$	1	-	20	kHz	
Screw torque	Mounting (M5)	-	2.5	-	3.0	N·m
	Terminal (M5)	-	2.5	-	3.0	N·m

Block diagram

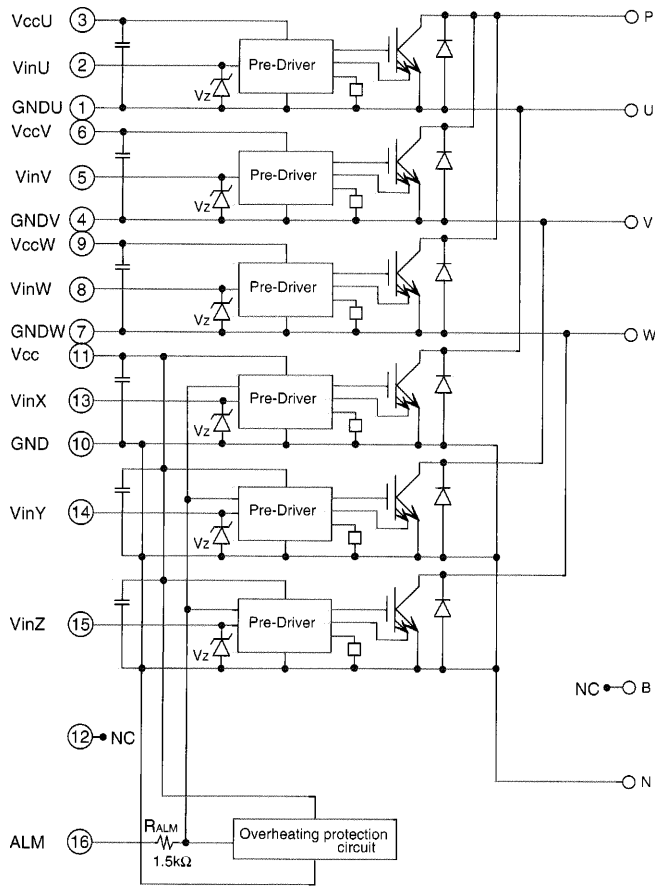

- Pre-drivers include following functions
- a) Amplifier for driver
  - b) Short circuit protection
  - c) Undervoltage lockout circuit
  - d) Over current protection
  - e) IGBT chip over heating protection

Outline drawings, mm

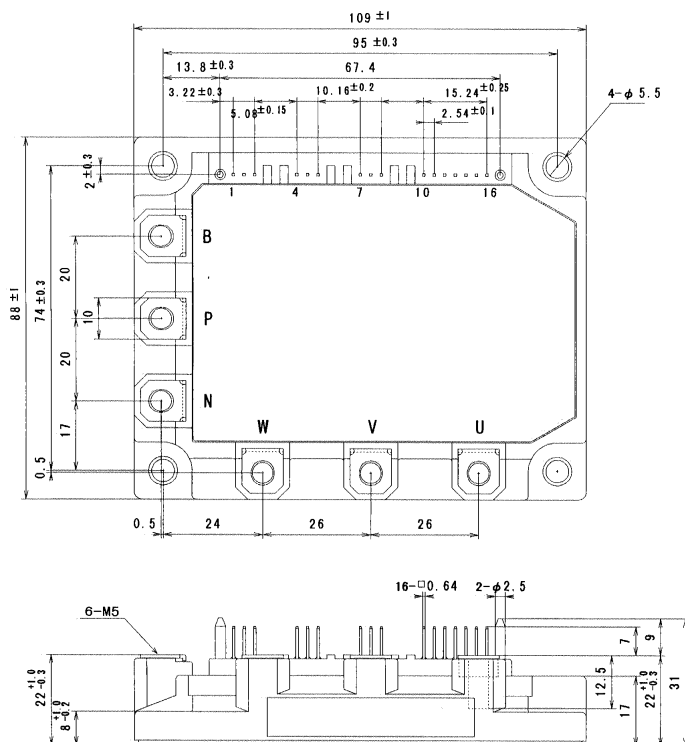

Mass : 440g

■ Characteristics (Representative)

● Control circuit

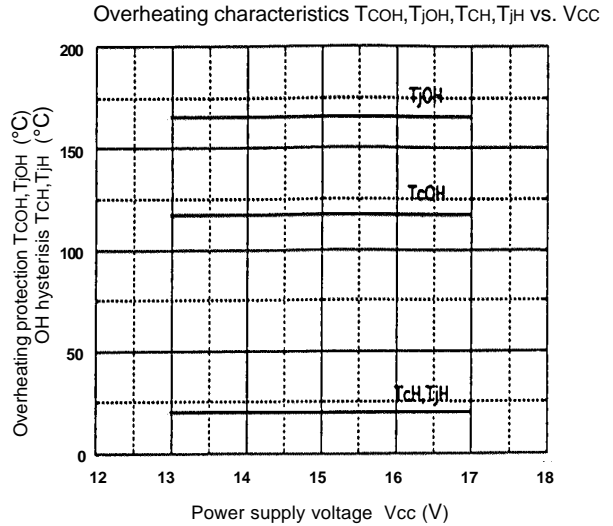
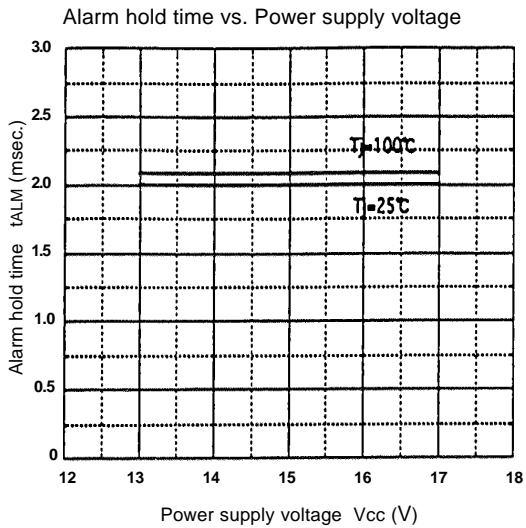
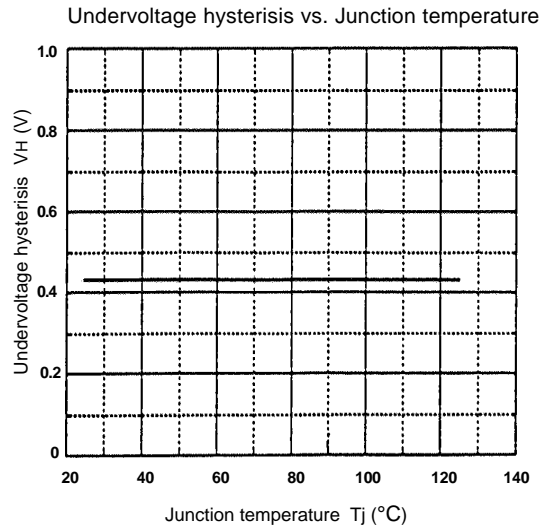
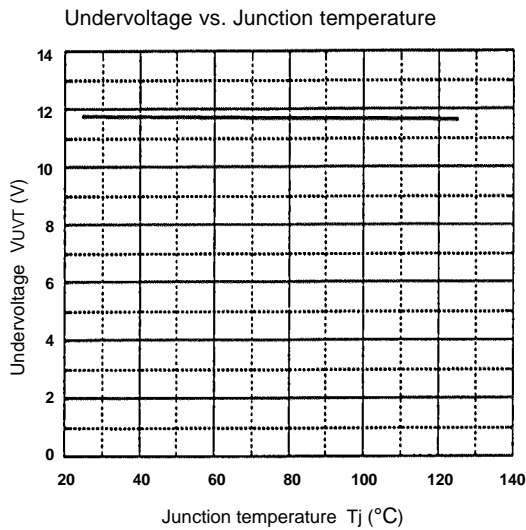
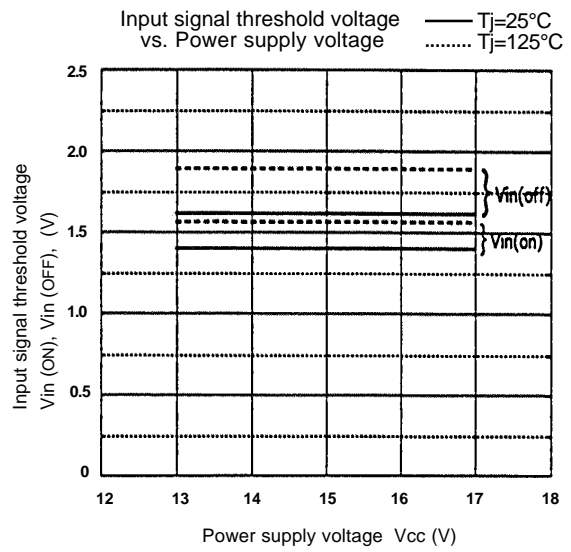
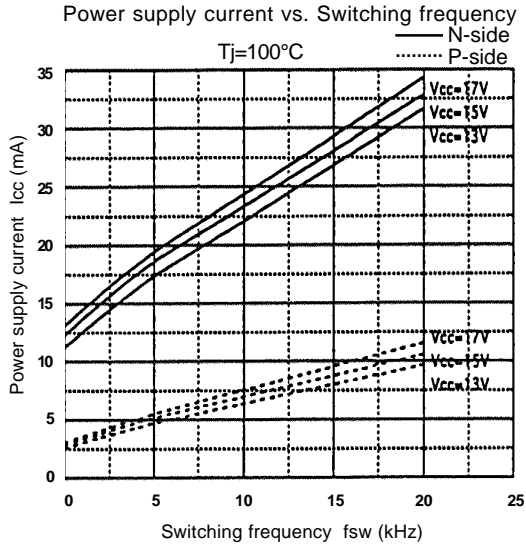

● Inverter

Collector current vs. Collector-Emitter voltage  
T<sub>j</sub>=25°C

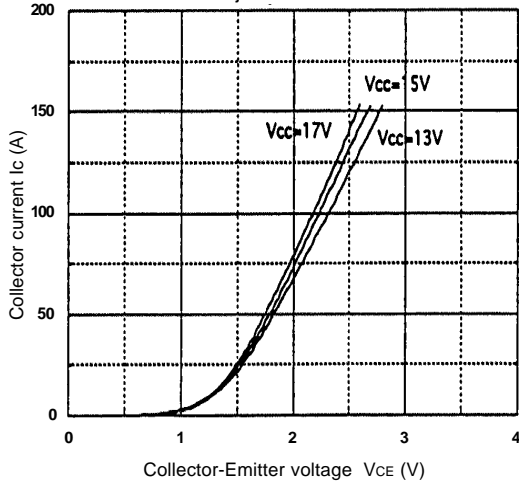

Collector current vs. Collector-Emitter voltage  
T<sub>j</sub>=125°C

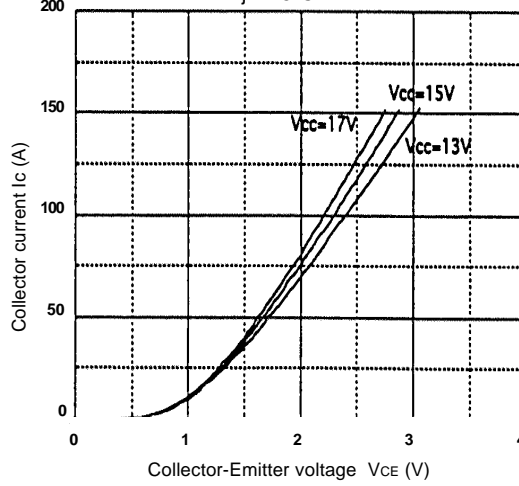

Switching time vs. Collector current  
E<sub>dc</sub>=300V, V<sub>cc</sub>=15V, T<sub>j</sub>=25°C

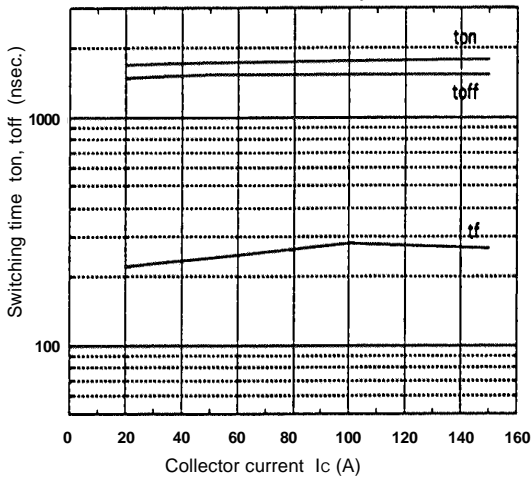

Switching time vs. Collector current  
E<sub>dc</sub>=300V, V<sub>cc</sub>=15V, T<sub>j</sub>=125°C

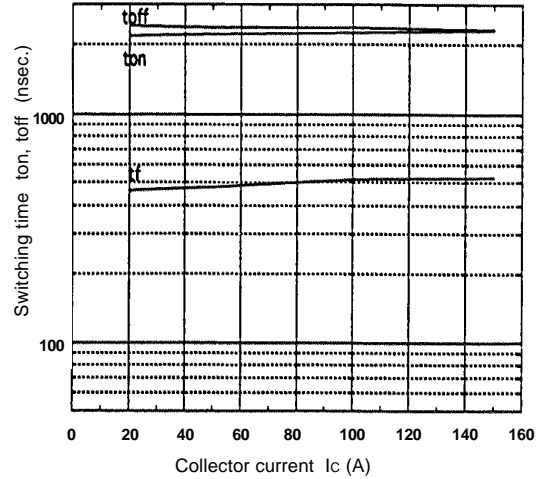

Forward current vs. Forward voltage

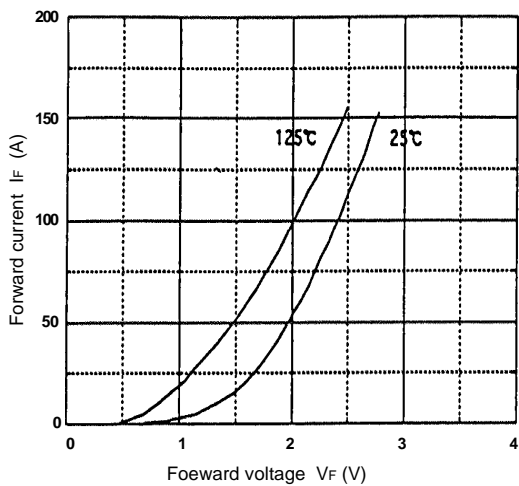

Reverse recovery characteristics trr, Irr, vs. If

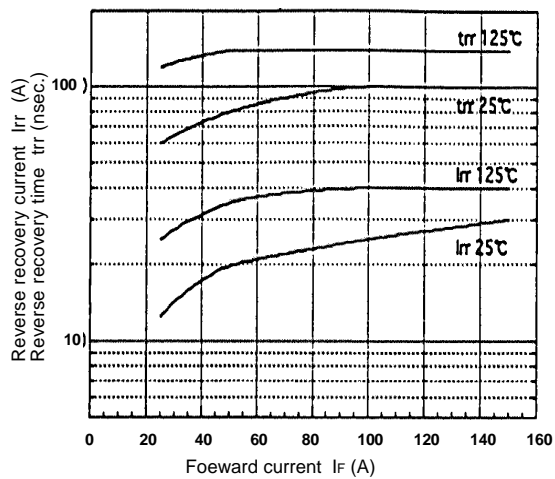

● Inverter

Transient thermal resistance

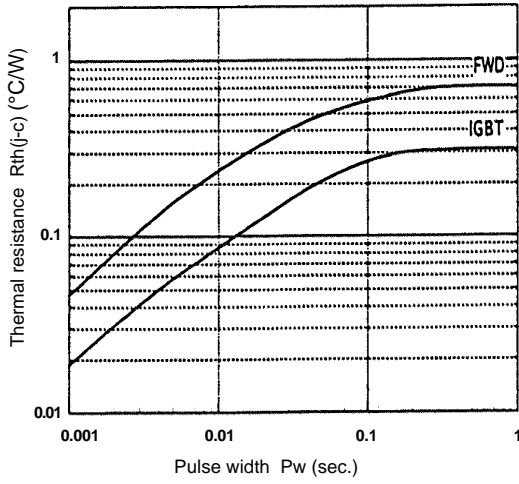

Reverse biased safe operating area  
 $V_{cc}=15V, T_j \leq 125^\circ C$

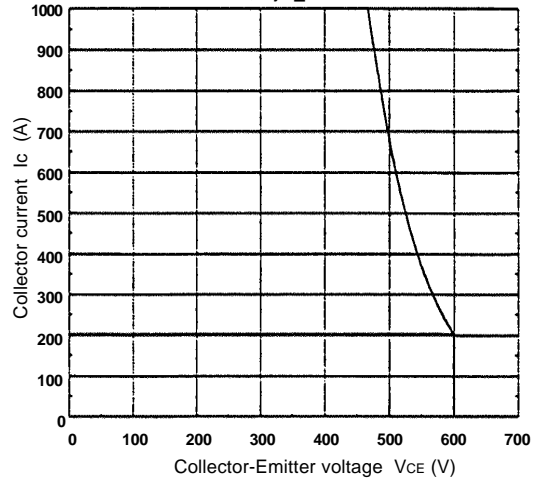

Power derating for IGBT (per device)

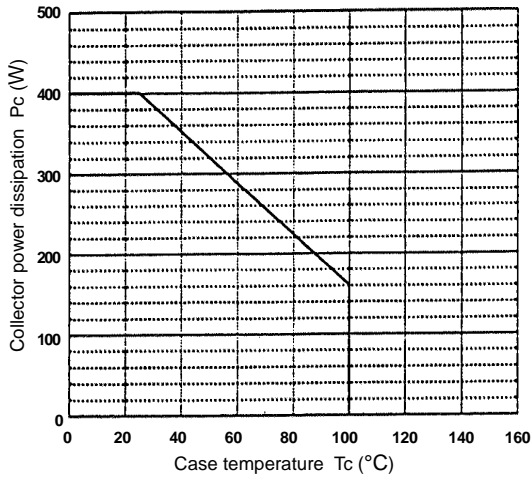

Power derating for FWD (per device)

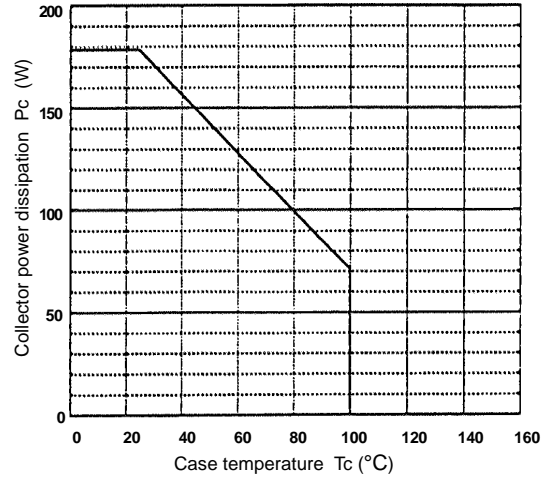

Switching loss vs. Collector current  
 $E_{dc}=300V, V_{cc}=15V, T_j=25^\circ C$

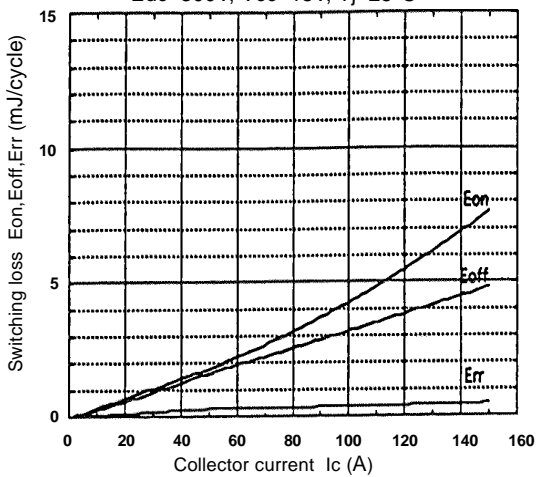

Switching loss vs. Collector current  
 $E_{dc}=300V, V_{cc}=15V, T_j=125^\circ C$

