

6MBP50RTB060

IPM-R3 series

600V / 50A 6 in one-package

Features

- Temperature protection provided by directly detecting the junction temperature of the IGBTs
- Low power loss and soft switching
- High performance and high reliability IGBT with overheating protection
- Higher reliability because of a big decrease in number of parts in built-in control circuit

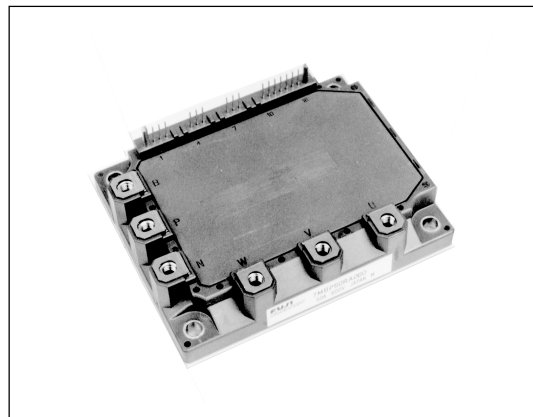

Maximum ratings and characteristics

- Absolute maximum ratings(at Tc=25°C unless otherwise specified)

Item	Symbol	Rating		Unit	
		Min.	Max.		
DC bus voltage	V _{DC}	0	450	V	
DC bus voltage (surge)	V _{DC(surge)}	0	500	V	
DC bus voltage (short operating)	V _{SC}	200	400	V	
Collector-Emitter voltage	V _{CES} *1	0	600	V	
INV Collector current	DC	I _C	-	50	A
	1ms	I _{CP}	-	100	A
	Duty=76.1%	-I _C *2	-	50	A
Collector power dissipation	One transistor	P _C *3	-	144	W
Junction temperature	T _j	-	150	°C	
Input voltage of power supply for Pre-Driver	V _{CC} *4	-0.5	20	V	
Input signal voltage	V _{in} *5	-0.5	V _{CC} +0.5	V	
Input signal current	I _{in}	-	3	mA	
Alarm signal voltage	V _{ALM} *6	-0.5	V _{CC}	V	
Alarm signal current	I _{ALM} *7	-	20	mA	
Storage temperature	T _{stg}	-40	125	°C	
Operating case temperature	T _{op}	-20	100	°C	
Isolating voltage (Case-Terminal)	V _{iso} *8	-	AC2.5	kV	
Screw torque	Mounting (M5)	-	3.5 *9	N·m	
	Terminal (M5)	-	3.5 *9	N·m	

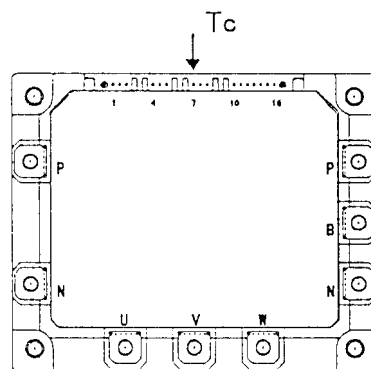

Fig.1 Measurement of case temperature

*1 : V_{CES} shall be applied to the input voltage between terminal P and U or V or W, N and U or V or W.

*2 : $125^{\circ}\text{C}/\text{FWD } R_{th(j-c)}/(I_c \times V_F \text{ MAX})=125/1.263/(50 \times 2.6) \times 100=76.1\%$

*3 : $P_c=125^{\circ}\text{C}/\text{IGBT } R_{th(j-c)}=125/0.87=144\text{W}$ [Inverter]

*4 : V_{CC} shall be applied to the input voltage between terminal No. 3 and 1, 6 and 4, 9 and 7, 11 and 10.

*5 : V_{in} shall be applied to the input voltage between terminal No. 2 and 1, 5 and 4, 8 and 7, 13,14,15 and 10.

*6 : V_{ALM} shall be applied to the voltage between terminal No. 16 and 10.

*7 : I_{ALM} shall be applied to the input current to terminal No. 16.

*8 : 50Hz/60Hz sine wave 1 minute.

*9 : Recommendable Value : 2.5 to 3.0 N·m

● **Electrical characteristics** (at $T_c=T_j=25^\circ\text{C}$, $V_{cc}=15\text{V}$ unless otherwise specified.)

Main circuit

Item		Symbol	Condition	Min.	Typ.	Max.	Unit	
INV	Collector current at off signal input	I_{CES}	$V_{CE}=600\text{V}$ V_{in} terminal open.	-	-	1.0	mA	
	Collector-Emitter saturation voltage	$V_{CE(sat)}$	$I_c=50\text{A}$	Terminal	-	-	2.5	V
				Chip	-	2.0	-	
	Forward voltage of FWD	V_F	$-I_c=50\text{A}$	Terminal	-	-	2.6	V
Chip				-	1.6	-		
Turn-on time		t_{on}	$V_{DC}=300\text{V}, T_j=125^\circ\text{C}$	1.2	-	-	μs	
Turn-off time		t_{off}	$I_c=50\text{A}$ Fig.1, Fig.6	-	-	3.6		
Reverse recovery time		t_{rr}	$V_{DC}=300\text{V}, I_c=50\text{A}$ Fig.1, Fig.6	-	-	0.3		
Maximum Avalanche Energy (A non-repetition)		P_{AV}	Internal wiring inductance=50nH Main circuit wiring inductance=54nH	30	-	-	mJ	

● **Control circuit**

Item	Symbol	Condition	Min.	Typ.	Max.	Unit
Supply current of P-line side pre-driver(one unit)	I_{ccp}	Switching Frequency : 0 to 15kHz $T_c=-20$ to 125°C Fig.7	-	-	18	mA
Supply current of N-line side pre-driver	I_{ccn}		-	-	65	mA
Input signal threshold voltage (on/off)	$V_{in(th)}$	ON	1.00	1.35	1.70	V
		OFF	1.25	1.60	1.95	V
Input zener voltage	V_Z	$R_{in}=20\text{k ohm}$	-	8.0	-	V
Alarm signal hold time	t_{ALM}	$T_c=-20^\circ\text{C}$ Fig.2	1.1	-	-	ms
		$T_c=25^\circ\text{C}$ Fig.2	-	2.0	-	ms
		$T_c=125^\circ\text{C}$ Fig.2	-	-	4.0	ms
Limiting resistor for alarm	R_{ALM}		1425	1500	1575	ohm

● **Protection Section** ($V_{cc}=15\text{V}$)

Item	Symbol	Condition	Min.	Typ.	Max.	Unit
Over Current Protection Level of Inverter circuit	I_{oc}	$T_j=125^\circ\text{C}$	75	-	-	A
Over Current Protection Delay time	t_{doc}	$T_j=125^\circ\text{C}$	-	5	-	μs
SC Protection Delay time	t_{sc}	$T_j=125^\circ\text{C}$ Fig.4	-	-	8	μs
IGBT Chip Over Heating	T_{jOH}	surface of IGBT chips	150	-	-	$^\circ\text{C}$
Over Heating Protection Hysteresis	T_{jH}	$V_{DC}=0\text{V}, I_c=0\text{A}$, Case temperature	-	20	-	$^\circ\text{C}$
Over Heating Protection Temperature Level	T_{COH}		110	-	125	$^\circ\text{C}$
Over Heating Protection Hysteresis	T_{CH}		-	20	-	
Under Voltage Protection Level	V_{UV}		11.0	-	12.5	V
Under Voltage Protection Hysteresis	V_H		0.2	0.5	-	

● **Thermal characteristics**($T_c=25^\circ\text{C}$)

Item	Symbol		Min.	Typ.	Max.	Unit
Junction to Case thermal resistance	INV	IGBT	-	-	0.87	$^\circ\text{C/W}$
		FWD	-	-	1.263	$^\circ\text{C/W}$
Case to fin thermal resistance with compound	Rth(c-f)		-	0.05	-	$^\circ\text{C/W}$

● **Noise Immunity** ($V_{DC}=300\text{V}$, $V_{cc}=15\text{V}$, Test Circuit Fig.5)

Item	Condition	Min.	Typ.	Max.	Unit
Common mode rectangular noise	Pulse width $1\mu\text{s}$, polarity \pm , 10minuets Judge : no over-current, no miss operating	± 2.0	-	-	kV
Common mode lightning surge	Rise time $1.2\mu\text{s}$, Fall time $50\mu\text{s}$ Interval 20s, 10 times Judge : no over-current, no miss operating	± 5.0	-	-	kV

● **Recommendable value**

Item	Symbol	Min.	Typ.	Max.	Unit
DC Bus Voltage	V_{DC}	-	-	400	V
Operating Supply Voltage of Pre-Driver	V_{cc}	13.5	15.0	16.5	V
Screw torque (M5)	-	2.5	-	3.0	Nm

● **Weight**

Item	Symbol	Min.	Typ.	Max.	Unit
Weight	W_t	-	450	-	g

*9 : (For 1 device, Case is under the device)

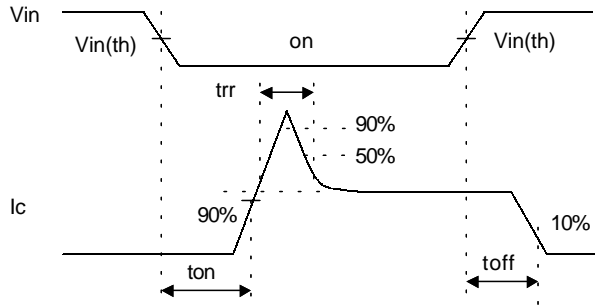
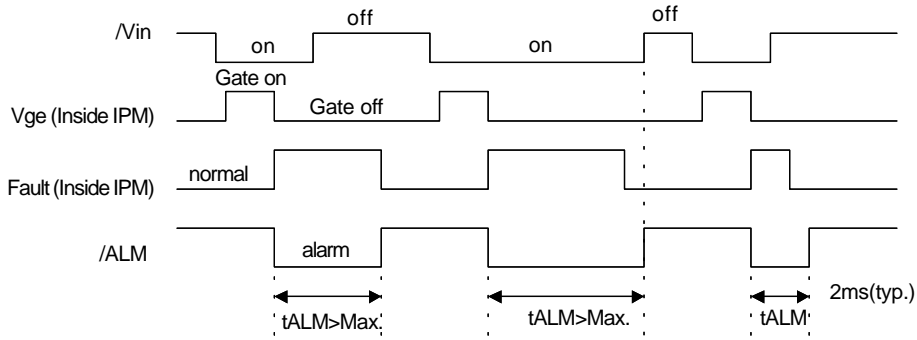

Figure 1. Switching Time Waveform Definitions



Fault : Over-current, Over-heat or Under-voltage

Figure 2. Input / Output Timing Diagram

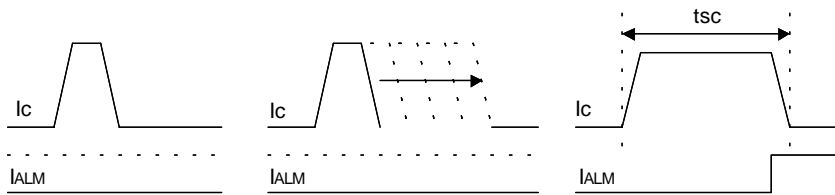

Figure. 4 Definition of tsc

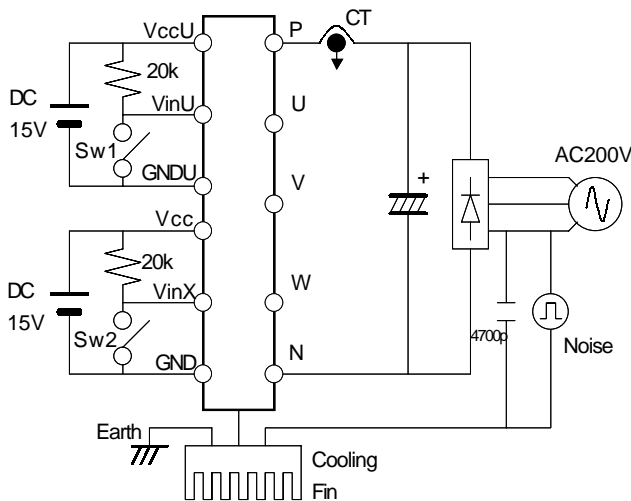

Figure 5. Noise Test Circuit

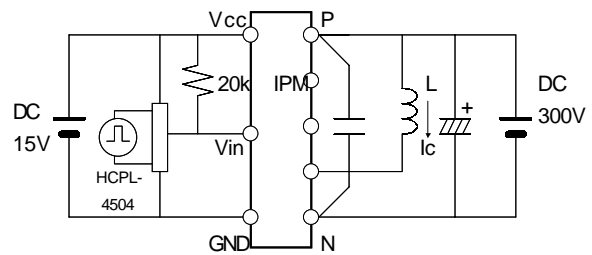

Figure 6. Switching Characteristics Test Circuit

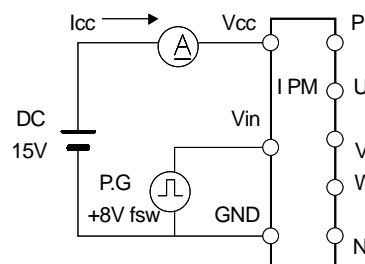
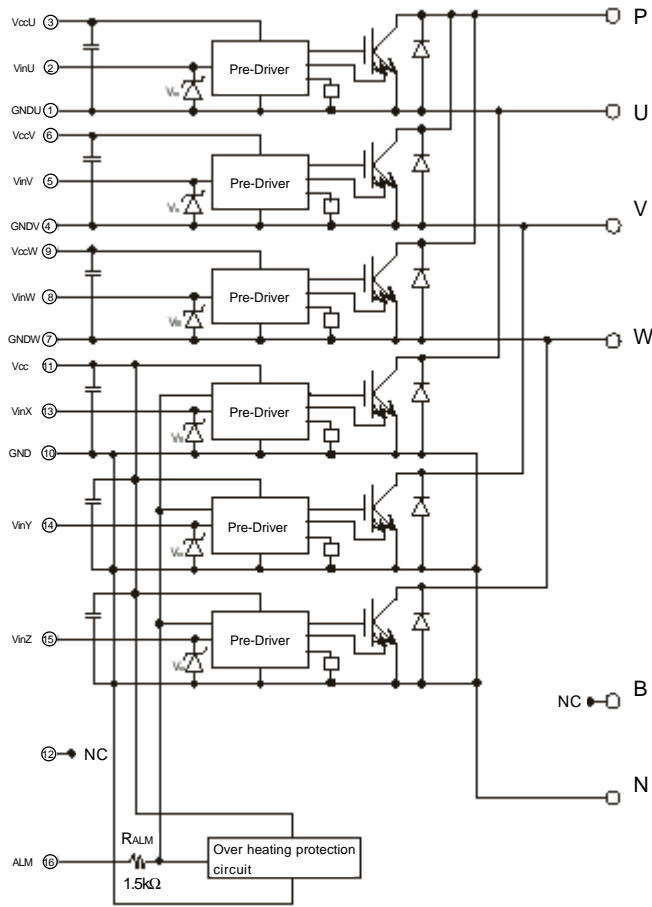

Figure 7. Icc Test Circuit

Block diagram



- Pre-driver include following functions
- ① Amplifier for drive
 - ② Short circuit protection
 - ③ Under voltage lockout circuit
 - ④ Over current protection
 - ⑤ IGBT chip over heating protection

Outline drawings, mm

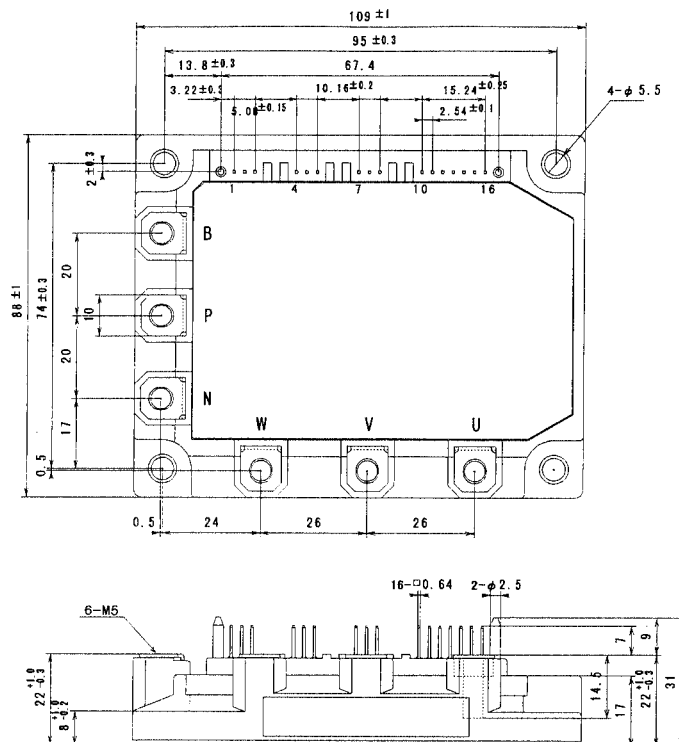

Mass : 450g

Characteristics

Control circuit characteristics (Representative)

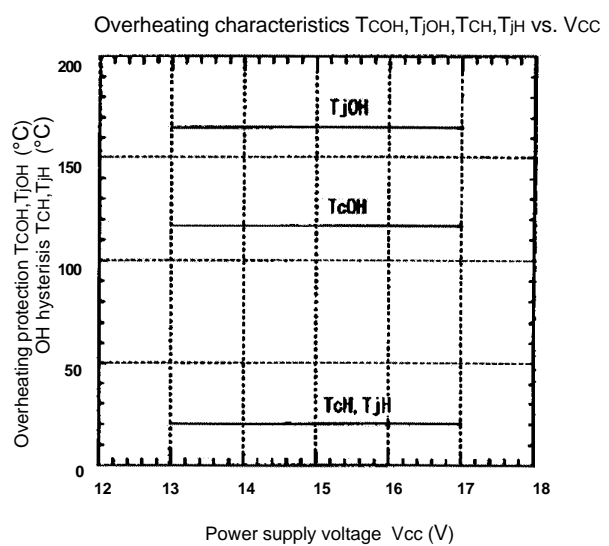
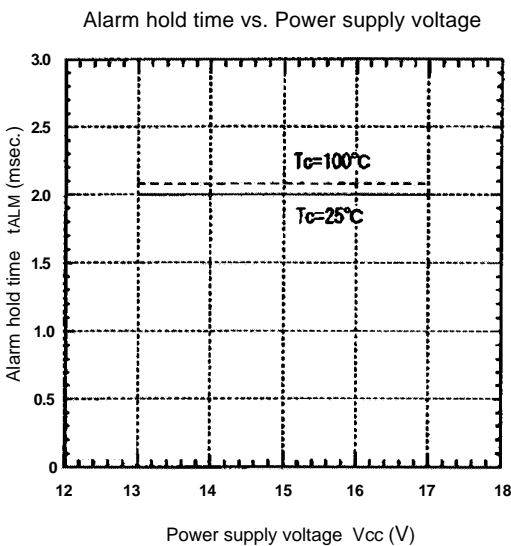
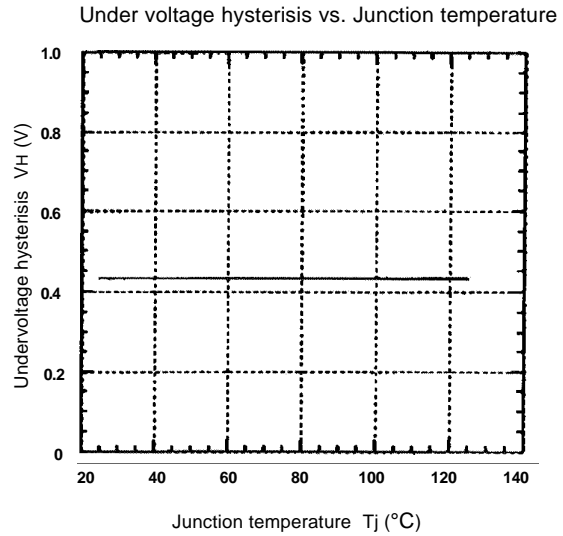
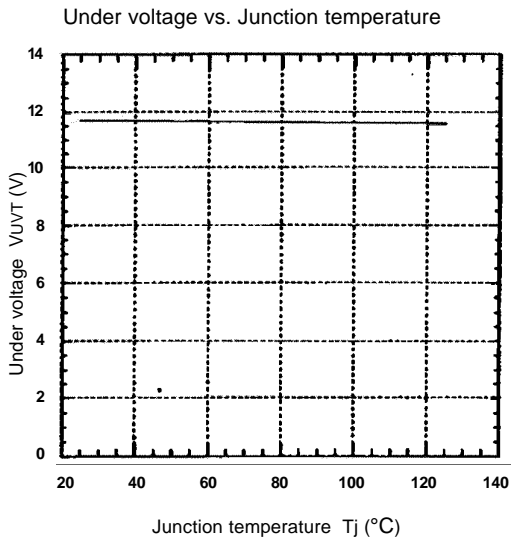
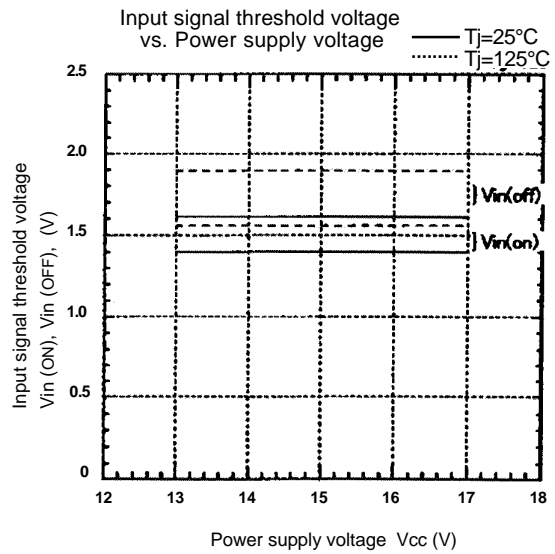
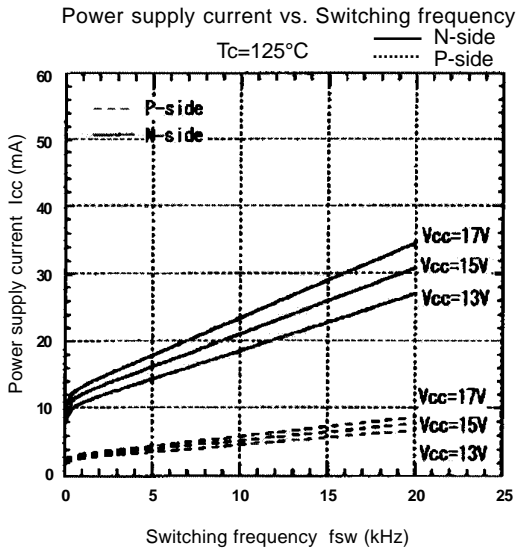

● Main circuit characteristics (Representative)

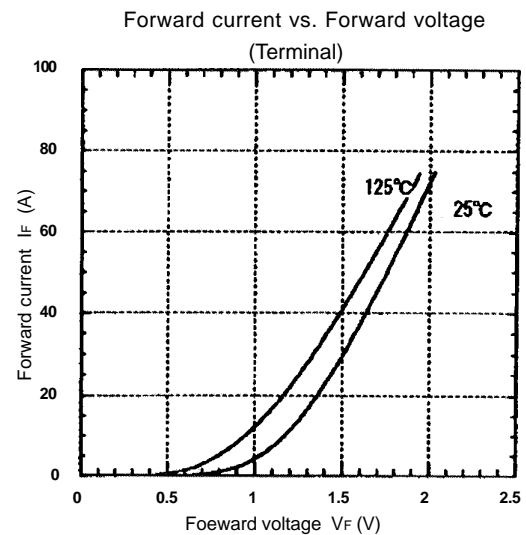
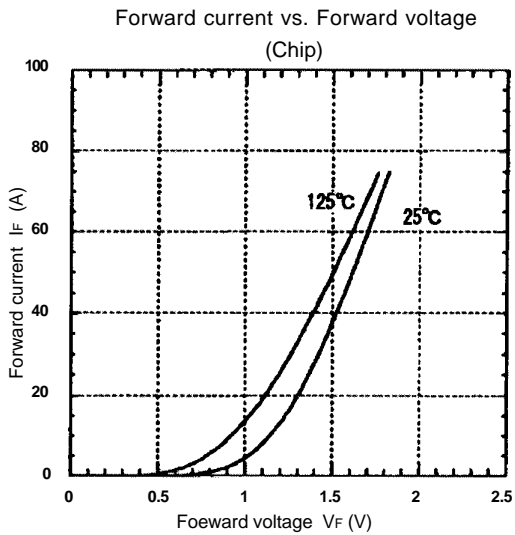
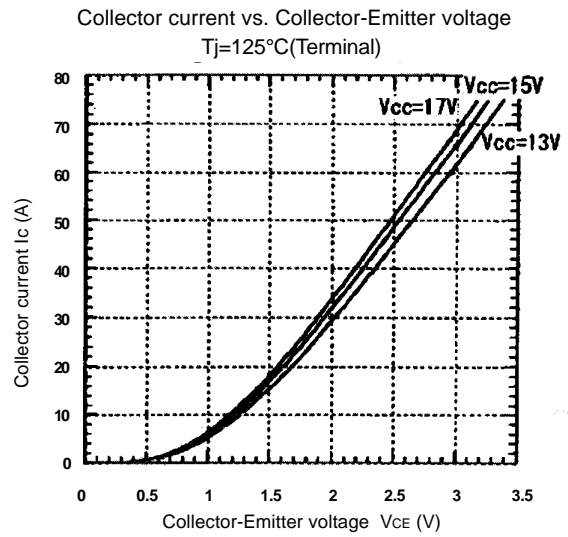
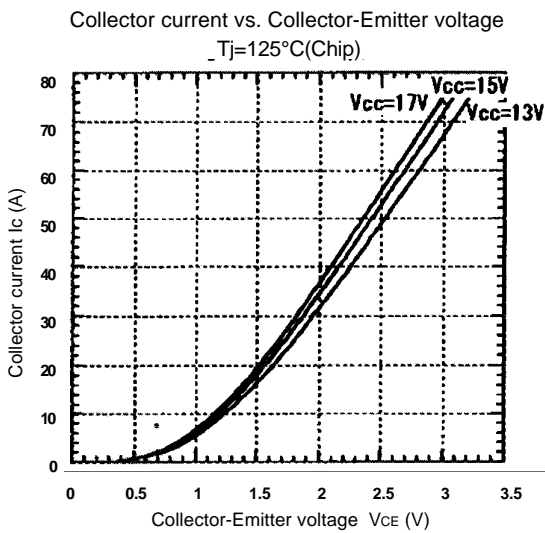
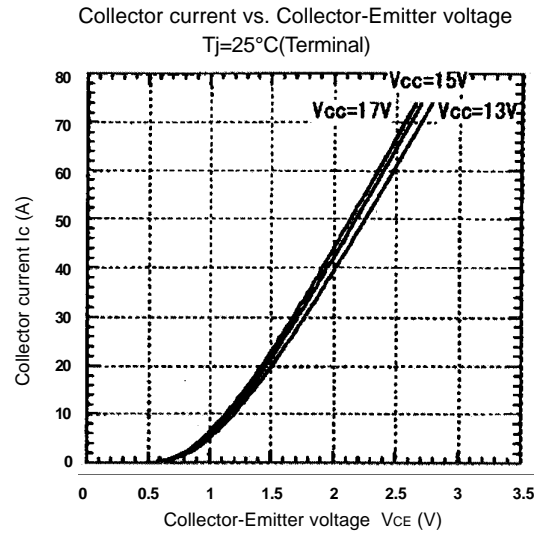
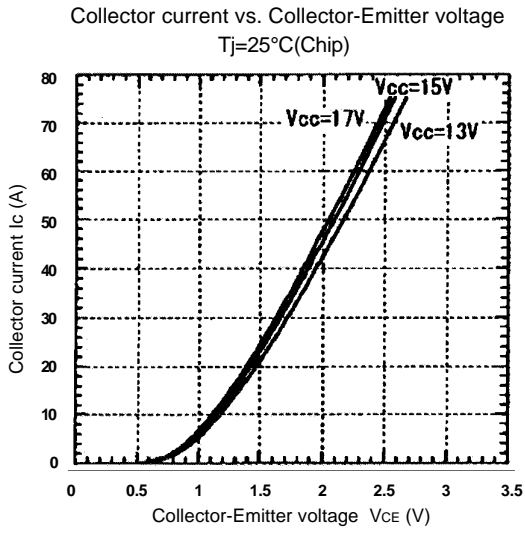

Switching Loss vs. Collector current
 $E_{dc}=300V, V_{cc}=15V, T_j=25^\circ C$

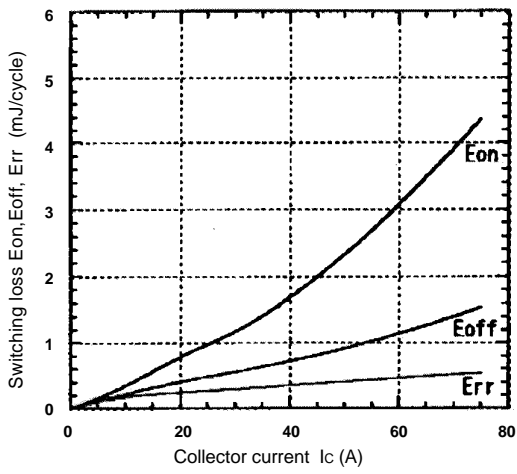

Switching Loss vs. Collector current
 $E_{dc}=300V, V_{cc}=15V, T_j=125^\circ C$

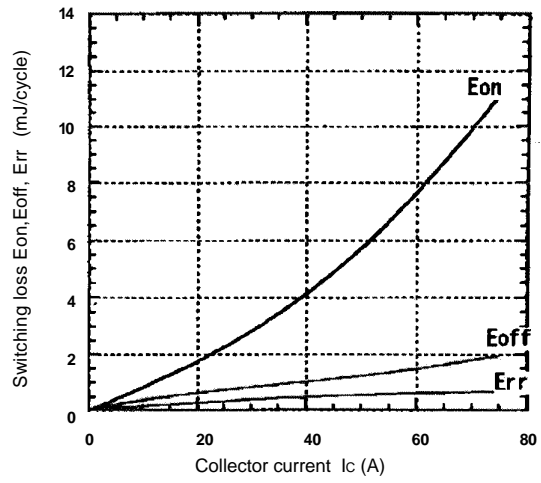

Reverse biased safe operating area
 $V_{cc}=15V, T_j \le 125^\circ C$

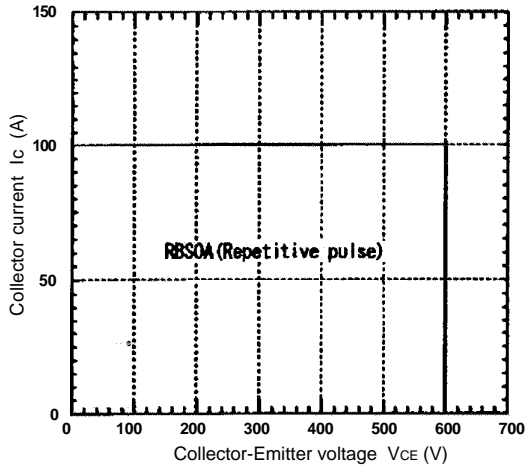

Transient thermal resistance

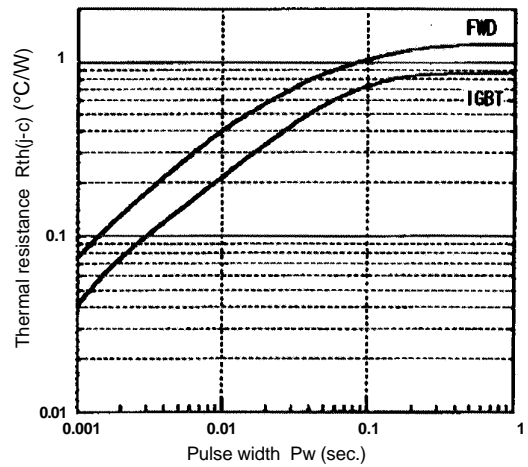

Power derating for IGBT (per device)

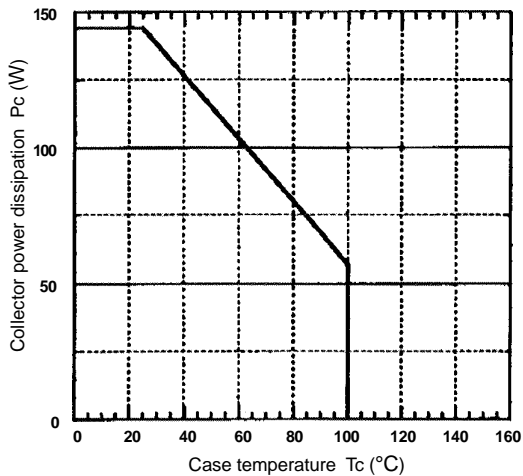

Power derating for FWD (per device)

