

IGBT MODULE (S series) 600V / 50A / PIM



■ Features

- Low $V_{CE(sat)}$
- Compact package
- P.C. board mount
- Converter diode bridge, Dynamic brake circuit

■ Applications

- Inverter for motor drive
- AC and DC servo drive amplifier
- Uninterruptible power supply

■ Maximum ratings and characteristics

● Absolute maximum ratings ($T_c=25^{\circ}\text{C}$ unless without specified)

Item	Symbol	Condition	Rating	Unit	
Inverter	Collector-Emitter voltage	V_{CES}	600	V	
	Gate-Emitter voltage	V_{GES}	± 20	V	
	Collector current	I_C	Continuous	50	A
		I_{CP}	1ms	100	A
		$-I_C$		50	A
Collector power dissipation	P_C	1 device	200	W	
Brake	Collector-Emitter voltage	V_{CES}	600	V	
	Gate-Emitter voltage	V_{GES}	± 20	V	
	Collector current	I_C	Continuous	30	A
		I_{CP}	1ms	60	A
	Collector power dissipation	P_C	1 device	120	W
Converter	Repetitive peak reverse voltage	V_{RRM}	600	V	
	Repetitive peak reverse voltage	V_{RRM}	800	V	
	Average output current	I_O	50Hz/60Hz sine wave	50	A
	Surge current (Non-Repetitive)	I_{FSM}	$T_j=150^{\circ}\text{C}$, 10ms	350	A
	I^2t (Non-Repetitive)	I^2t	half sine wave	613	A^2s
Operating junction temperature	T_j		+150	$^{\circ}\text{C}$	
Storage temperature	T_{stg}		-40 to +125	$^{\circ}\text{C}$	
Isolation between terminal and copper base *2	V_{iso}	AC : 1 minute	AC 2500	V	
			AC 2500	V	
voltage between thermistor and others *3			AC 2500	V	
Mounting screw torque			3.5 *1	N·m	

*1 Recommendable value : 2.5 to 3.5 N·m (M5)

*2 All terminals should be connected together when isolation test will be done.

*3 Terminal 8 and 9 should be connected together. Terminal 1 to 7 and 10 to 24 should be connected together and shorted to copper base.

● Electrical characteristics (Tj=25°C unless otherwise specified)

Item	Symbol	Condition	Characteristics			Unit		
			Min.	Typ.	Max.			
Inverter	Zero gate voltage collector current	ICES	VCE=600V, VGE=0V		1.0	mA		
	Gate-Emitter leakage current	IGES	VCE=0V, VGE=±20V		0.2	µA		
	Gate-Emitter threshold voltage	VGE(th)	VCE=20V, Ic=50mA		5.5	7.8	8.5	V
	Collector-Emitter saturation voltage	VCE(sat)	VGE=15V, Ic=50A	chip	1.8		V	
				terminal	1.95	2.4		
	Input capacitance	Cies	VGE=0V, VCE=10V, f=1MHz		5000		pF	
	Turn-on time	ton	VCC=300V		0.45	1.2	µs	
		tr	Ic=50A		0.25	0.6		
		tr(i)	VGE=±15V		0.08			
	Turn-off	toff	RG=51Ω		0.40	1.0		
tf				0.05	0.35			
Forward on voltage	VF	IF=50A	chip	1.75		V		
			terminal	1.9	2.6			
Reverse recovery time of FRD	trr	IF=50A			0.3	µs		
Brake	Zero gate voltage collector current	ICES	VCEs=600V, VGE=0V		1.0	mA		
	Gate-Emitter leakage current	IGES	VCE=0V, VGE=±20V		0.2	µA		
	Collector-Emitter saturation voltage	VCE(sat)	Ic=30A, VGE=15V	chip	1.8		V	
				terminal	1.95	2.4		
	Turn-on time	ton	VCC=300V		0.45	1.2	µs	
		tr	Ic=30A		0.25	0.6		
	Turn-off time	toff	VGE=±15V		0.40	1.0		
		tf	RG=82Ω		0.05	0.35		
	Reverse current	Irrm	VR=600V			1.0	mA	
	Converter	Forward on voltage	VFM	IF=50A	chip	1.1	V	
terminal					1.2	1.5		
Reverse current	Irrm	VR=800V			1.0	mA		
Thermistor	Resistance	R	T=25°C		5000		Ω	
			T=100°C		465	495		520
	B value	B	T=25/50°C		3305	3375	3450	K

● Thermal resistance Characteristics

Item	Symbol	Condition	Characteristics			Unit
			Min.	Typ.	Max.	
Thermal resistance (1 device)	Rth(j-c)	Inverter IGBT			0.63	°C/W
		Inverter FWD			1.33	
		Brake IGBT			1.04	
		Converter Diode			0.90	
Contact thermal resistance *	Rth(c-f)	With thermal compound		0.05		

* This is the value which is defined mounting on the additional cooling fin with thermal compound

■ Equivalent Circuit Schematic

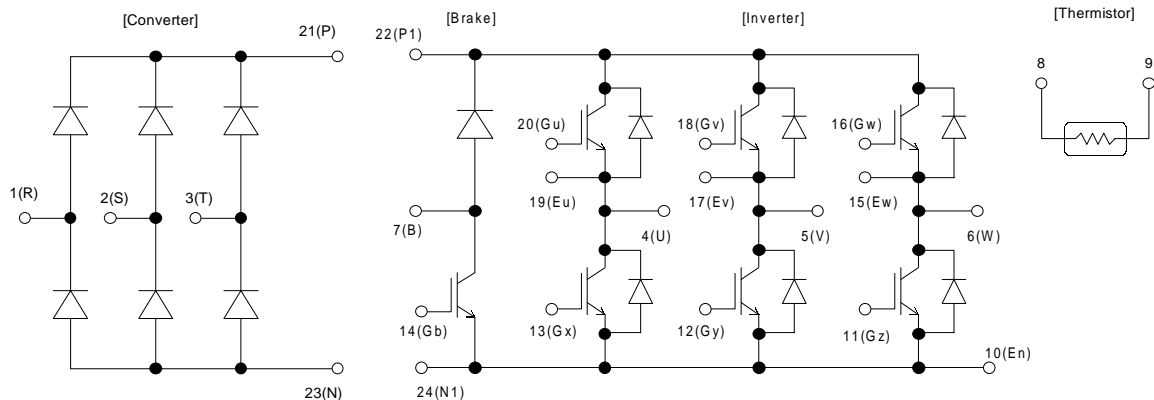

Characteristics (Representative)

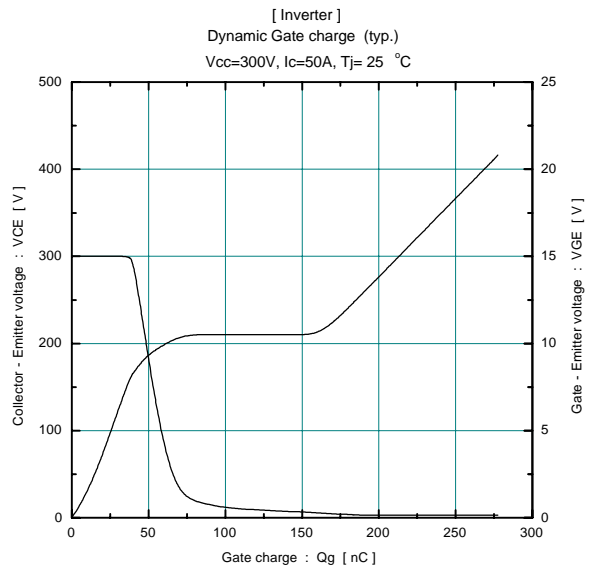
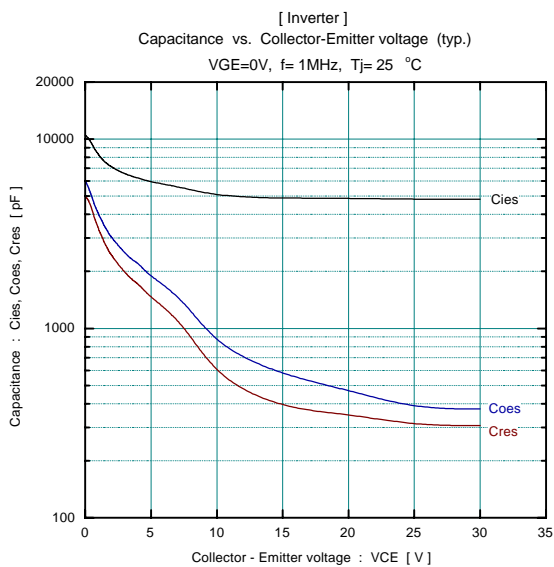
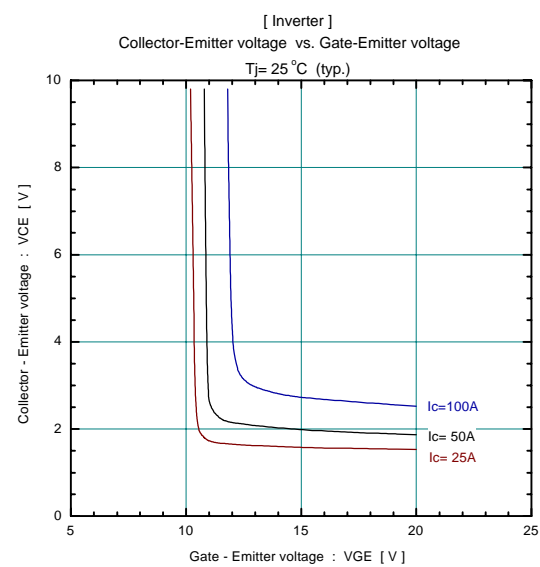
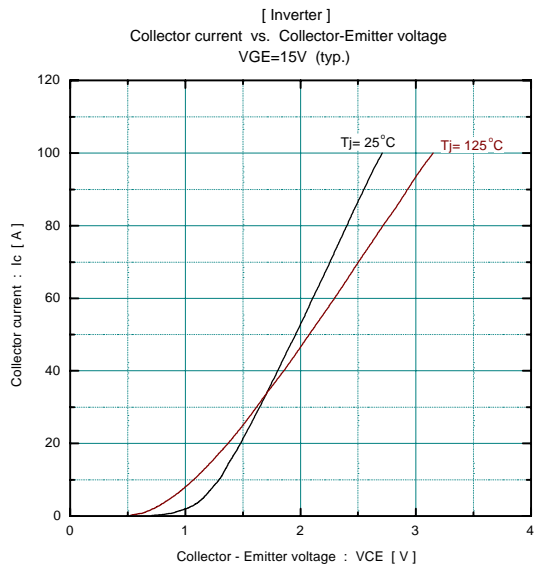
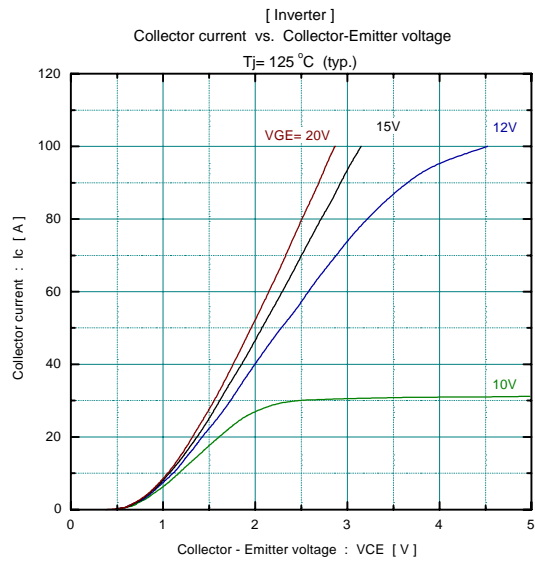
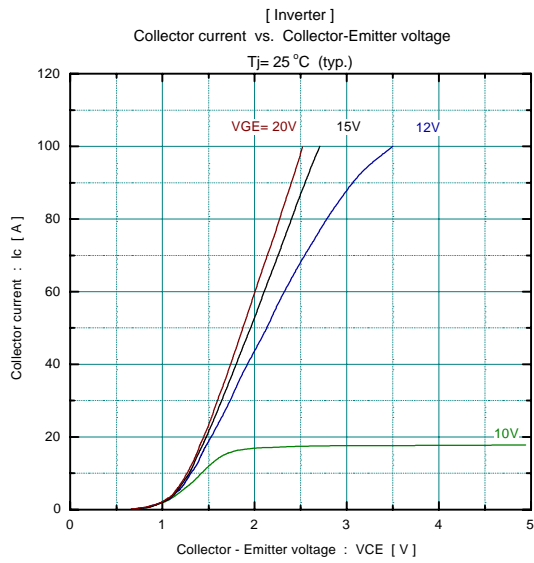

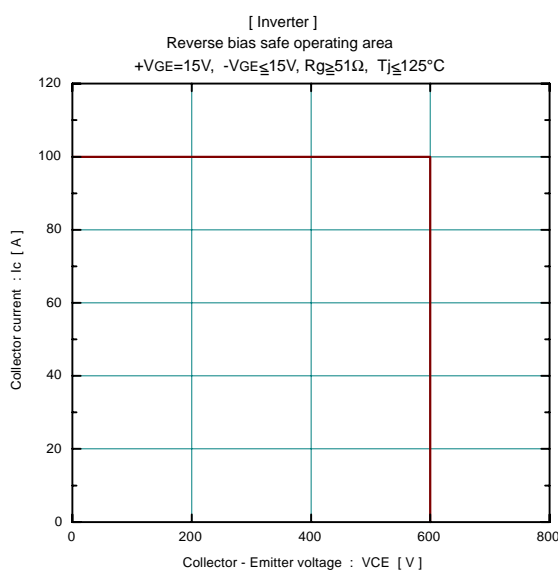
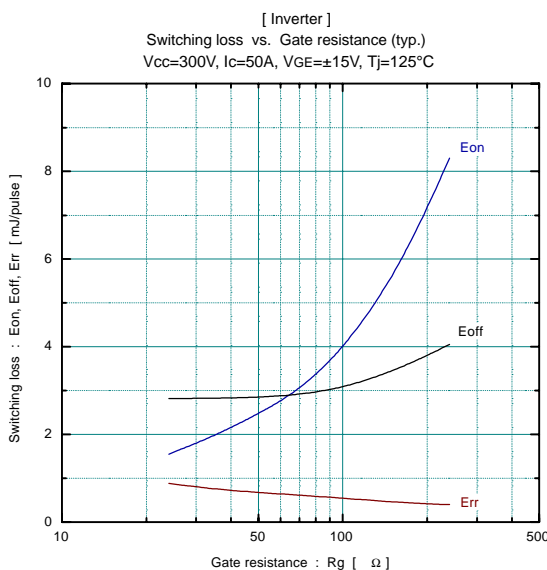
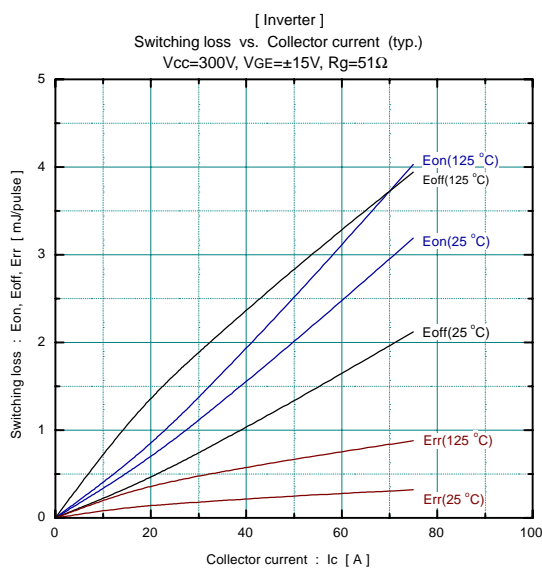
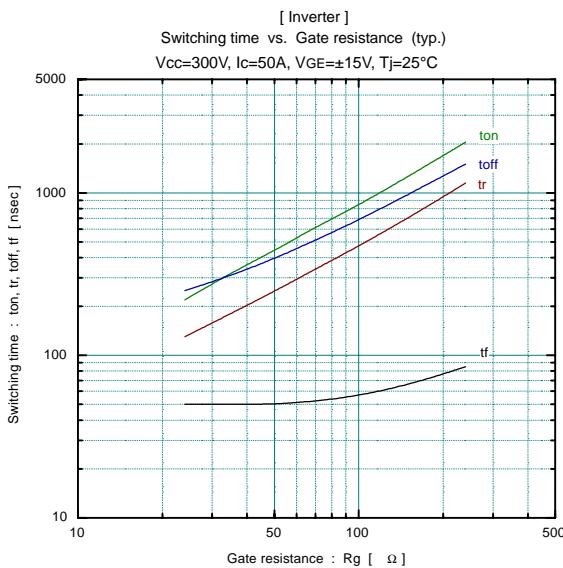
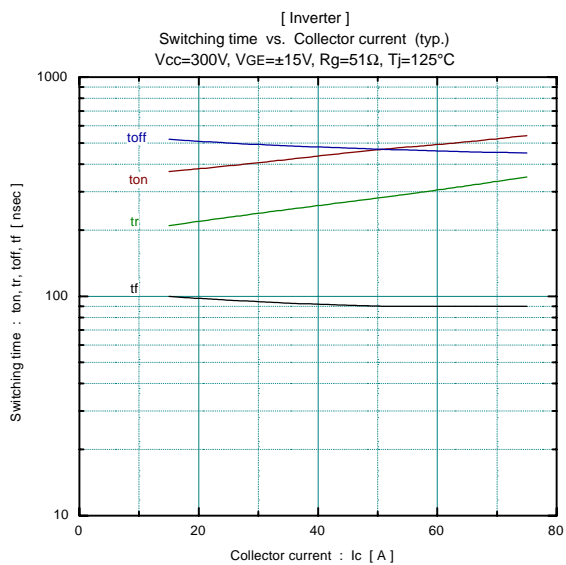
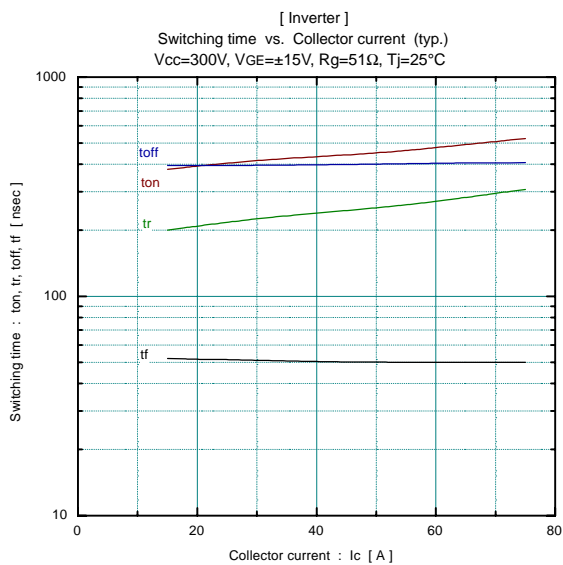

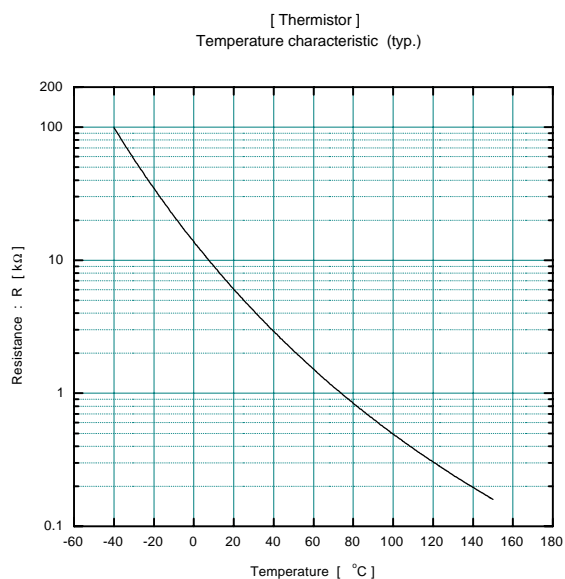
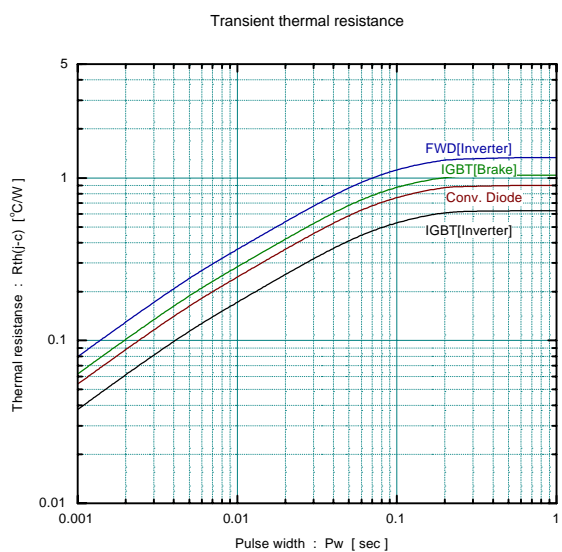
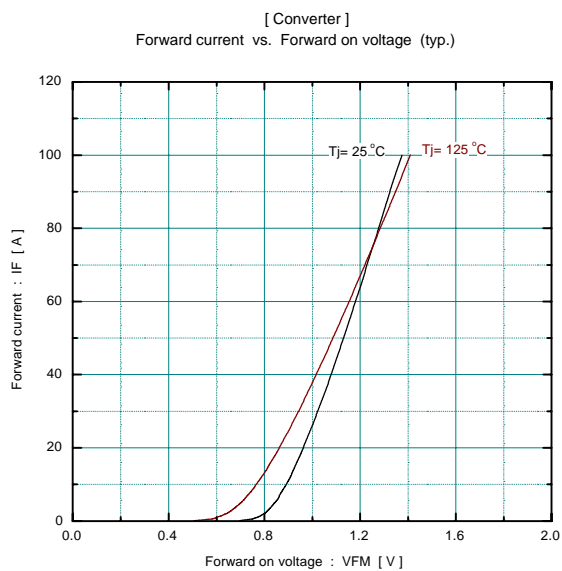
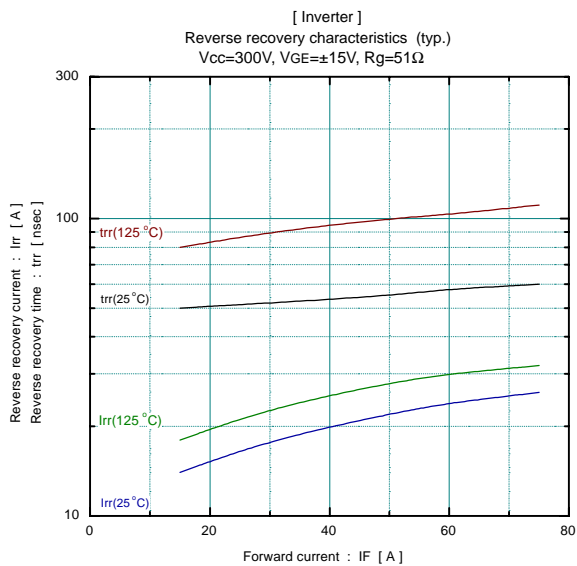
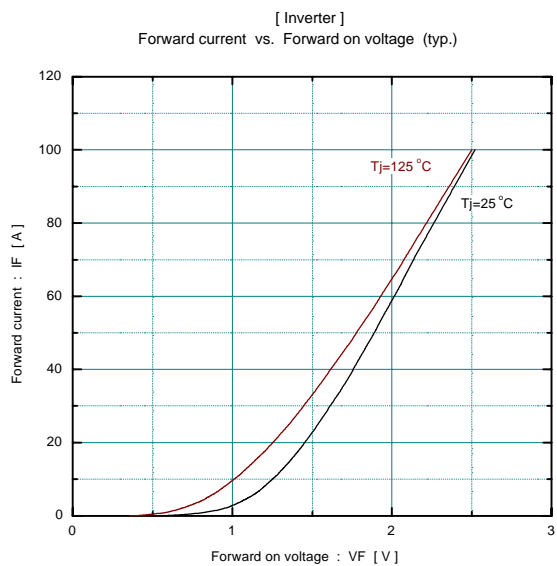

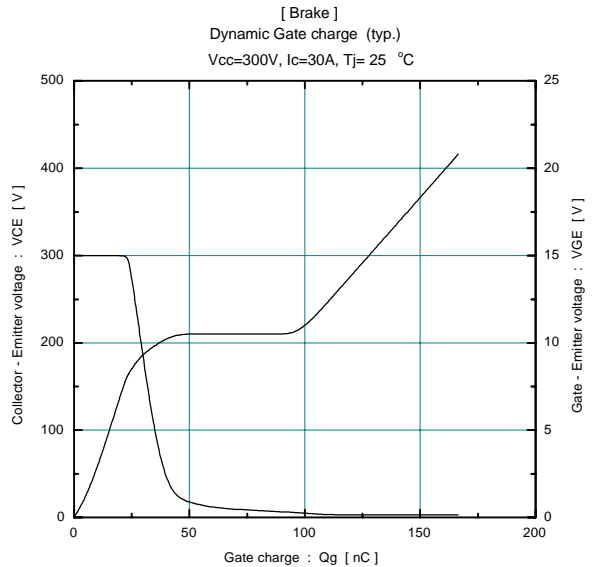
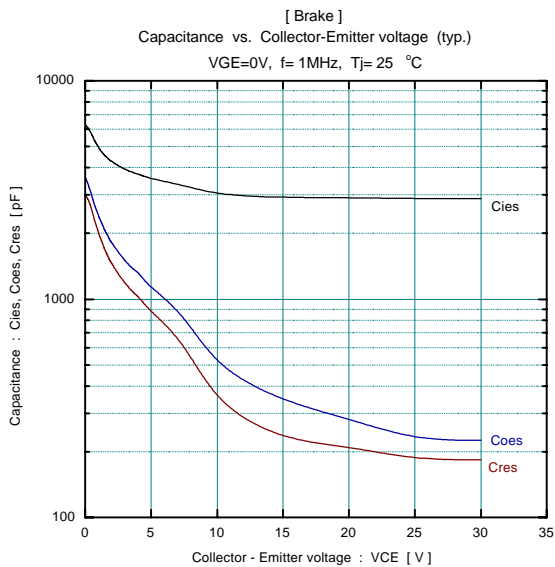
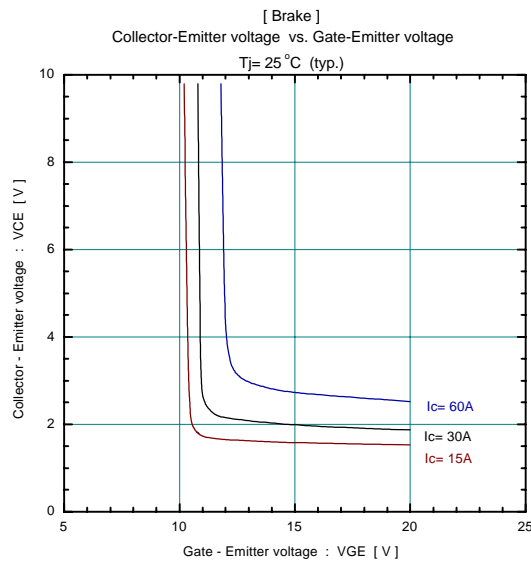
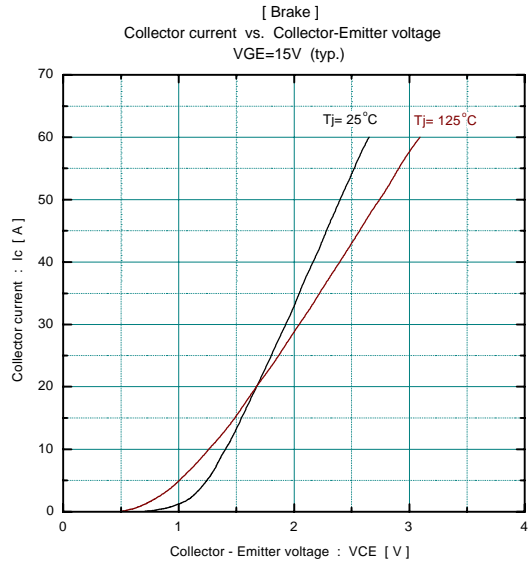
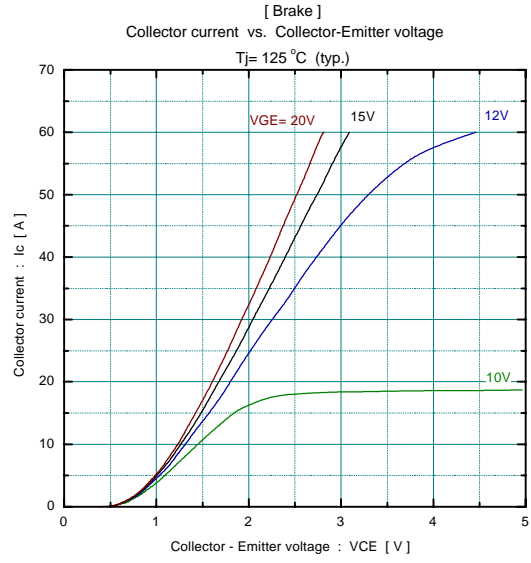
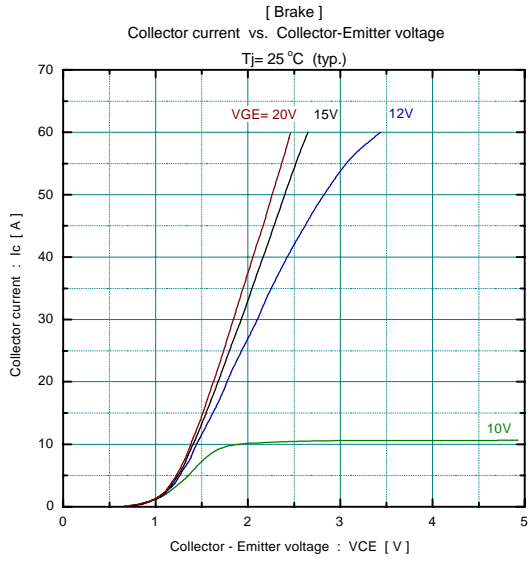

■ Outline Drawings, mm

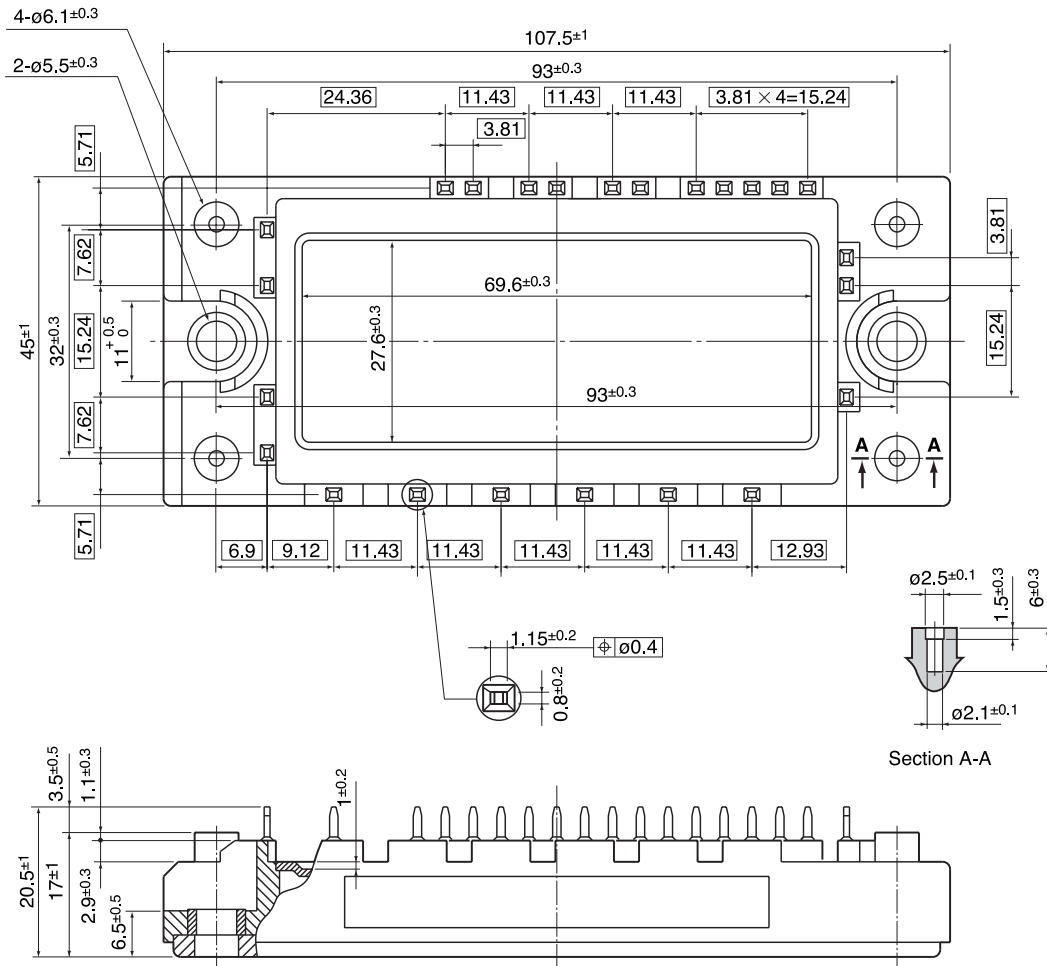

□ Shows theory dimensions