

FEATURES

- Double Side Cooling
- High Surge Capability

APPLICATIONS

- High Power Drives
- High Voltage Power Supplies
- Static Switches

VOLTAGE RATINGS

Part and Ordering Number	Repetitive Peak Voltages V_{DRM} and V_{RRM} V	Conditions
DCR3990A52*	5200	$T_{vj} = -40^{\circ}\text{C}$ to 125°C , $I_{DRM} = I_{RRM} = 300\text{mA}$, $V_{DRM}, V_{RRM} t_p = 10\text{ms}$, V_{DSM} & $V_{RSM} =$ V_{DRM} & $V_{RRM} + 100\text{V}$ respectively
DCR3990A50	5000	
DCR3990A45	4500	

Lower voltage grades available.
 *5000V @ -40°C , 5200V @ 0°C

ORDERING INFORMATION

When ordering, select the required part number shown in the Voltage Ratings selection table.

For example:

DCR3990A52

Note: Please use the complete part number when ordering and quote this number in any future correspondence relating to your order.

KEY PARAMETERS

V_{DRM}	5200V
$I_{T(AV)}$	3990A
I_{TSM}	53400A
dV/dt^*	2000V/ μs
di/dt	400A/ μs

* Higher dV/dt selections available

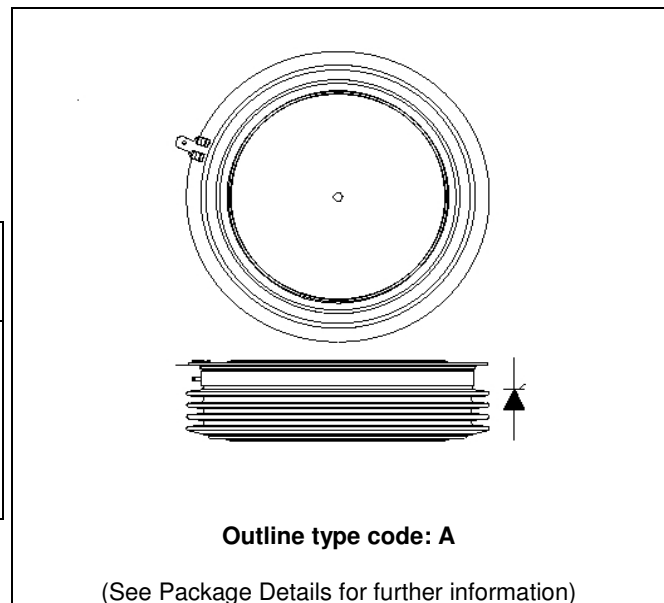

Fig. 1 Package outline

CURRENT RATINGS

$T_{case} = 60^{\circ}\text{C}$ unless stated otherwise

Symbol	Parameter	Test Conditions	Max.	Units
Double Side Cooled				
$I_{T(AV)}$	Mean on-state current	Half wave resistive load	3990	A
$I_{T(RMS)}$	RMS value	-	6270	A
I_T	Continuous (direct) on-state current	-	5640	A

SURGE RATINGS

Symbol	Parameter	Test Conditions	Max.	Units
I_{TSM}	Surge (non-repetitive) on-state current	10ms half sine, $T_{case} = 125^{\circ}\text{C}$	53.4	kA
I^2t	I^2t for fusing	$V_R = 0$	14.25	MA^2s

THERMAL AND MECHANICAL RATINGS

Symbol	Parameter	Test Conditions	Min.	Max.	Units	
$R_{th(j-c)}$	Thermal resistance – junction to case	Double side cooled	DC	-	0.00603	$^{\circ}\text{C/W}$
		Single side cooled	Anode DC	-	0.01024	$^{\circ}\text{C/W}$
			Cathode DC	-	0.01467	$^{\circ}\text{C/W}$
$R_{th(c-h)}$	Thermal resistance – case to heatsink	Clamping force 83.0kN (with mounting compound)	Double side	-	0.001	$^{\circ}\text{C/W}$
			Single side	-	0.002	$^{\circ}\text{C/W}$
T_{vj}	Virtual junction temperature	On-state (conducting)	-	135	$^{\circ}\text{C}$	
		Reverse (blocking)	-	125	$^{\circ}\text{C}$	
T_{stg}	Storage temperature range		-55	125	$^{\circ}\text{C}$	
F_m	Clamping force		74.0	91.0	kN	

DYNAMIC CHARACTERISTICS

Symbol	Parameter	Test Conditions	Min.	Max.	Units	
I_{RRM}/I_{DRM}	Peak reverse and off-state current	At V_{RRM}/V_{DRM} , $T_{case} = 125^{\circ}C$	-	300	mA	
dV/dt	Max. linear rate of rise of off-state voltage	To 67% V_{DRM} , $T_j = 125^{\circ}C$, gate open	-	2000	V/ μs	
dl/dt	Rate of rise of on-state current	From 67% V_{DRM} to $2x I_{T(AV)}$	Repetitive 50Hz	-	400	A/ μs
		Gate source 30V, 10 Ω , $t_r < 0.5\mu s$, $T_j = 125^{\circ}C$	Non-repetitive	-	1000	A/ μs
$V_{T(TO)}$	Threshold voltage – Low level	1000 to 2600A at $T_{case} = 125^{\circ}C$	-	0.85	V	
	Threshold voltage – High level	2600 to 9000A at $T_{case} = 125^{\circ}C$	-	0.99	V	
r_T	On-state slope resistance – Low level	1000 to 2600A at $T_{case} = 125^{\circ}C$	-	0.2115	m Ω	
	On-state slope resistance – High level	2600 to 9000A at $T_{case} = 125^{\circ}C$	-	0.1578	m Ω	
t_{gd}	Delay time	$V_D = 67\% V_{DRM}$, gate source 30V, 10 Ω $t_r = 0.5\mu s$, $T_j = 25^{\circ}C$	-	3	μs	
t_q	Turn-off time	$T_j = 125^{\circ}C$, $V_R = 200V$, $dl/dt = 1A/\mu s$, $dV_{DR}/dt = 20V/\mu s$ linear	-	750	μs	
Q_S	Stored charge	$I_T = 3000A$, $T_j = 125^{\circ}C$, $dl/dt = 1A/\mu s$, $V_{Rpeak} \sim 3100V$, $V_R \sim 2100V$	4030	5420	μC	
I_{RR}	Reverse recovery current		49	59	A	
I_L	Latching current	$T_j = 25^{\circ}C$, $V_D = 5V$	-	3	A	
I_H	Holding current	$T_j = 25^{\circ}C$, $R_{G-K} = \infty$, $I_{TM} = 500A$, $I_T = 5A$	-	300	mA	

GATE TRIGGER CHARACTERISTICS AND RATINGS

Symbol	Parameter	Test Conditions	Max.	Units
V _{GT}	Gate trigger voltage	V _{DRM} = 5V, T _{case} = 25 °C	1.5	V
V _{GD}	Gate non-trigger voltage	At 50% V _{DRM} , T _{case} = 125 °C	0.4	V
I _{GT}	Gate trigger current	V _{DRM} = 5V, T _{case} = 25 °C	300	mA
I _{GD}	Gate non-trigger current	At 50% V _{DRM} , T _{case} = 125 °C	10	mA

CURVES

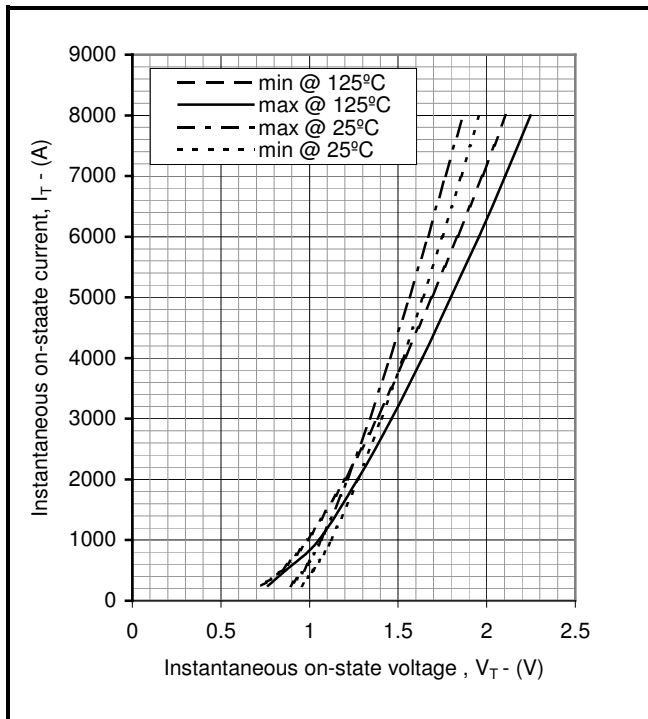

Fig.2 Maximum & minimum on-state characteristics

V_{TM} EQUATION

$$V_{TM} = A + B \ln(I_T) + C \cdot I_T + D \cdot \sqrt{I_T}$$

Where A = 0.061592
 B = 0.115333
 C = 0.000119
 D = 0.002394

these values are valid for T_j = 125 °C for I_T 250A to 9000A

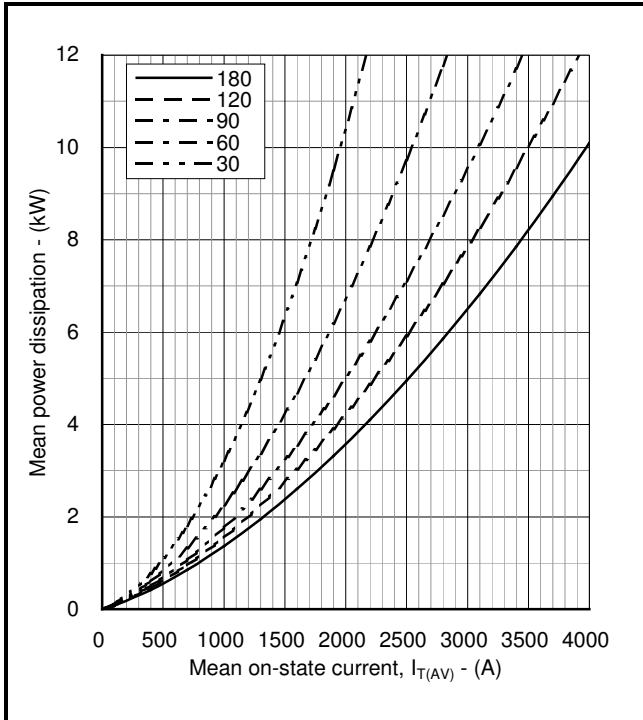

Fig.3 On-state power dissipation – sine wave

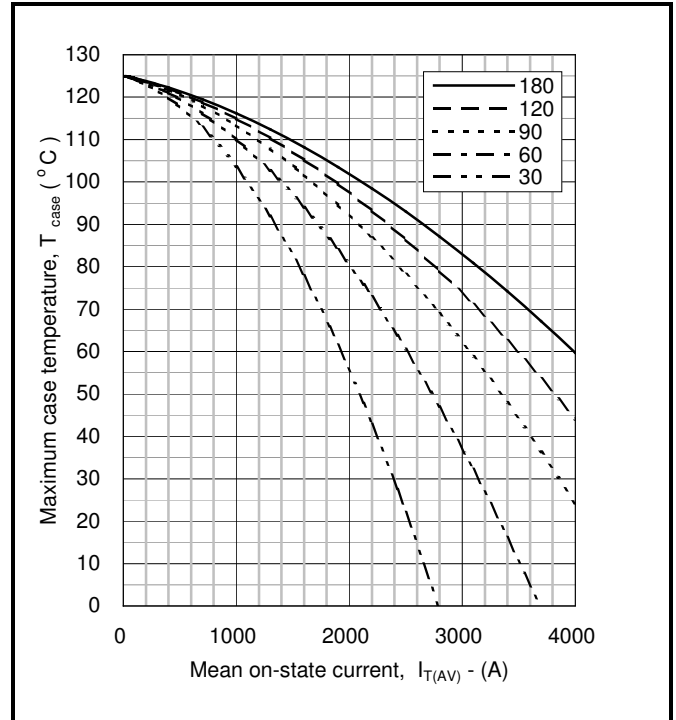

Fig.4 Maximum permissible case temperature, double side cooled – sine wave

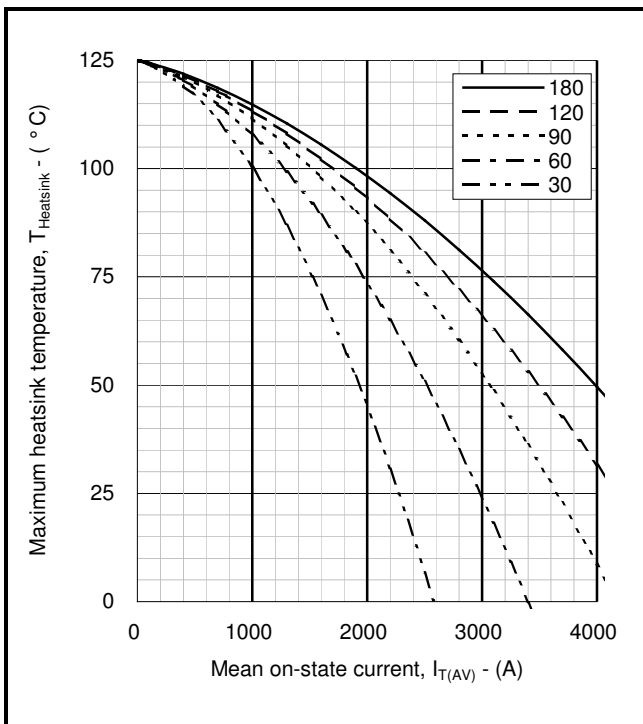

Fig.5 Maximum permissible heatsink temperature, double side cooled – sine wave

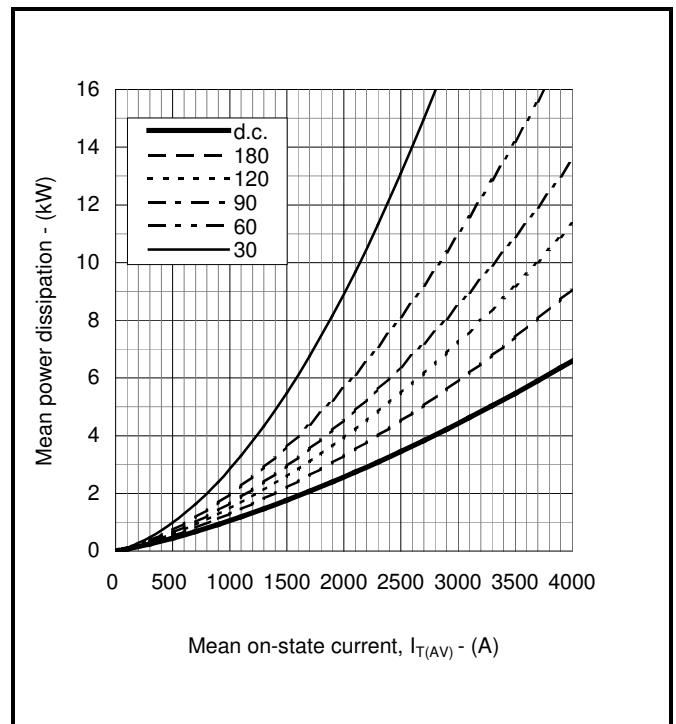

Fig.6 On-state power dissipation – rectangular wave

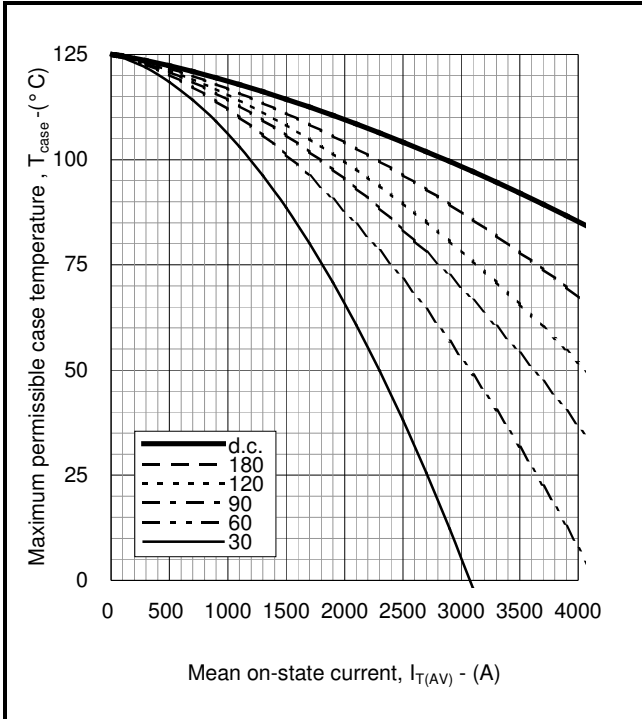

Fig.7 Maximum permissible case temperature, double side cooled – rectangular wave

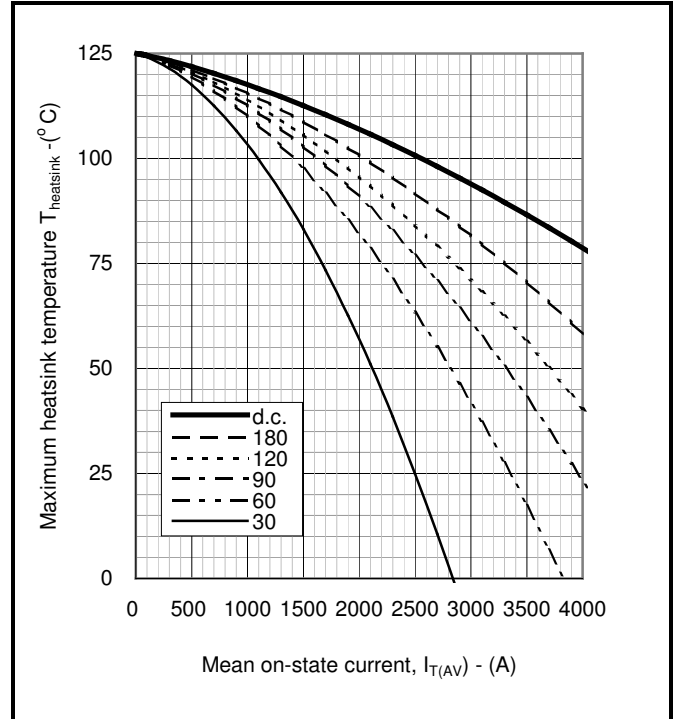

Fig.8 Maximum permissible heatsink temperature, double side cooled – rectangular wave

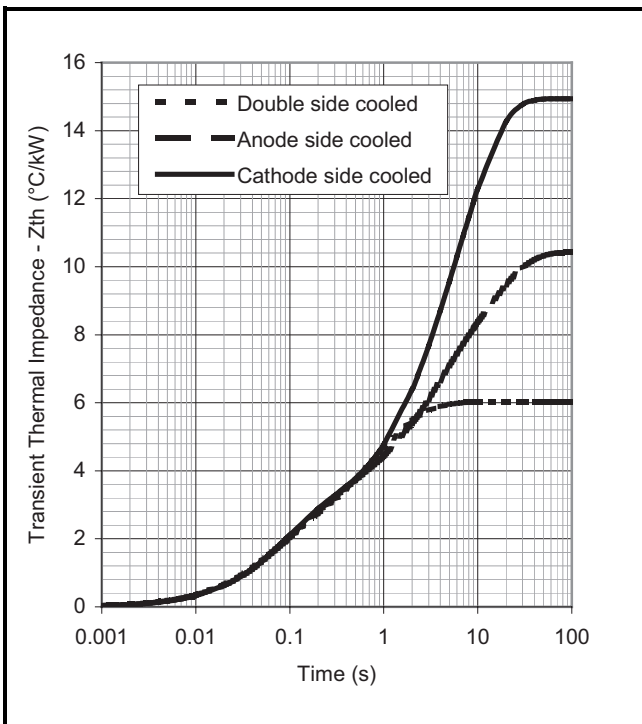

Fig.9 Maximum (limit) transient thermal impedance – junction to case (°C/kW)

		1	2	3	4
Double side cooled	R _i (°C/kW)	3.01541	1.048955	0.983519	0.983519
	T _i (s)	0.703874	1.904794	0.059	0.059
Anode side cooled	R _i (°C/kW)	3.156003	4.092806	1.556555	1.623962
	T _i (s)	2.69023	13.79162	0.059	0.205916
Cathode side cooled	R _i (°C/kW)	7.077369	3.483481	1.745839	2.634274
	T _i (s)	6.648601	8.436484	1.762119	0.08069

$$Z_{th} = \sum_{i=1}^{i=4} [R_i \times (1 - \exp(-T/T_i))]$$

ΔR_{th(j-c)} Conduction

Tables show the increments of thermal resistance R_{th(j-c)} when the device operates at conduction angles other than d.c.

θ °	Double side cooling	
	sine.	rect.
180	0.44	0.31
120	0.49	0.43
90	0.55	0.49
60	0.60	0.55
30	0.64	0.61
15	0.66	0.64

θ °	Anode Side Cooling	
	sine.	rect.
180	0.42	0.30
120	0.47	0.41
90	0.52	0.46
60	0.57	0.52
30	0.61	0.58
15	0.62	0.61

θ °	Cathode Sided Cooling	
	sine.	rect.
180	0.42	0.30
120	0.47	0.41
90	0.52	0.46
60	0.57	0.52
30	0.60	0.58
15	0.62	0.60

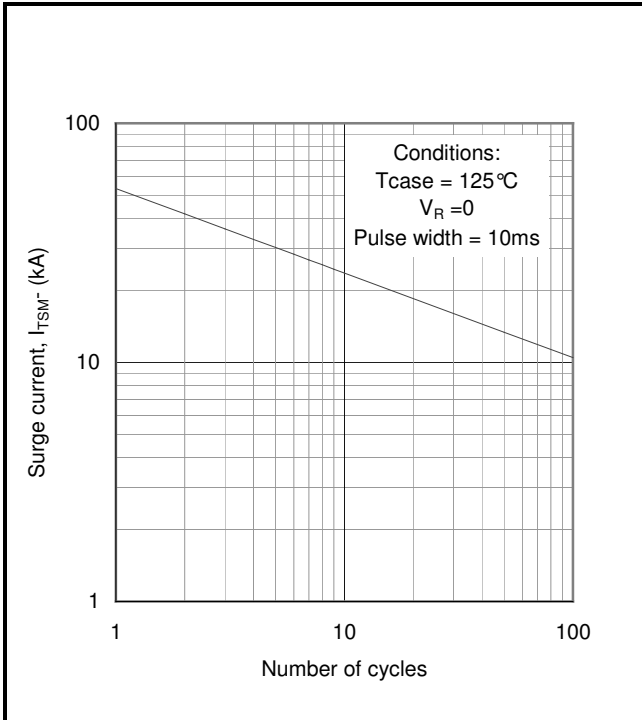

Fig.10 Multi-cycle surge current

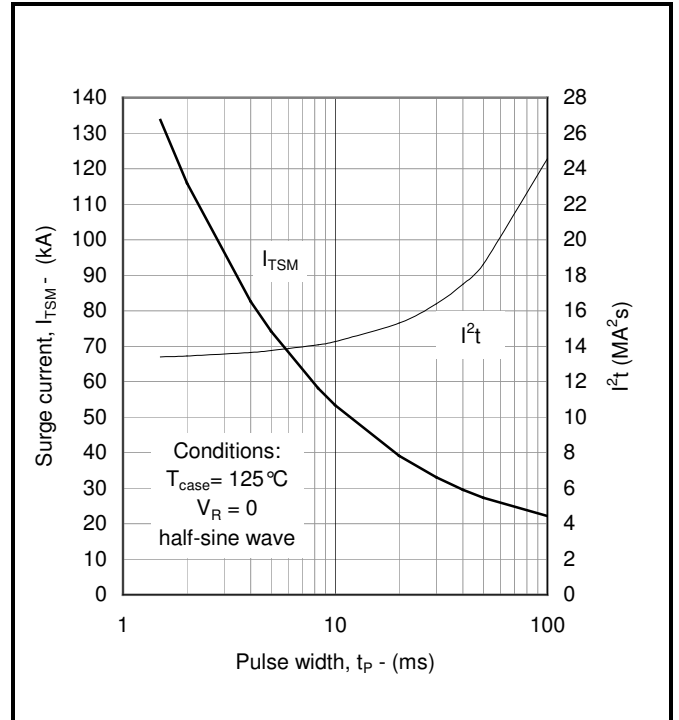

Fig.11 Single-cycle surge current

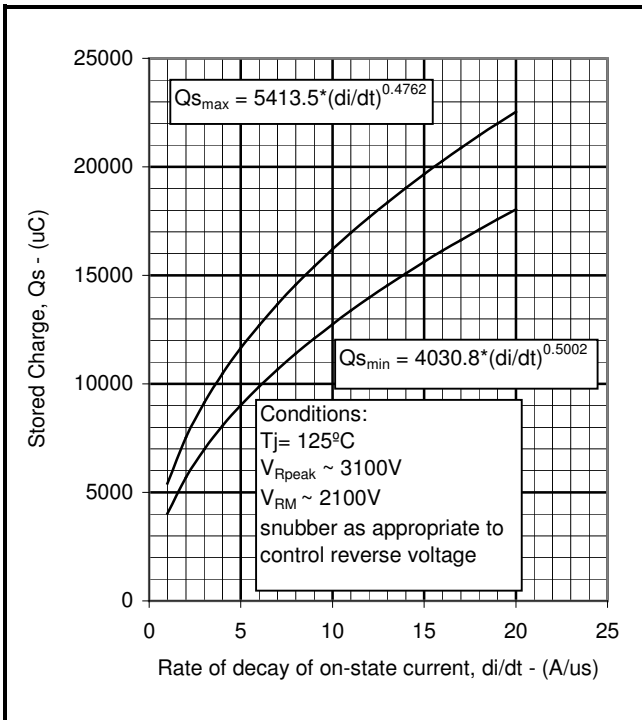

Fig.12 Stored charge

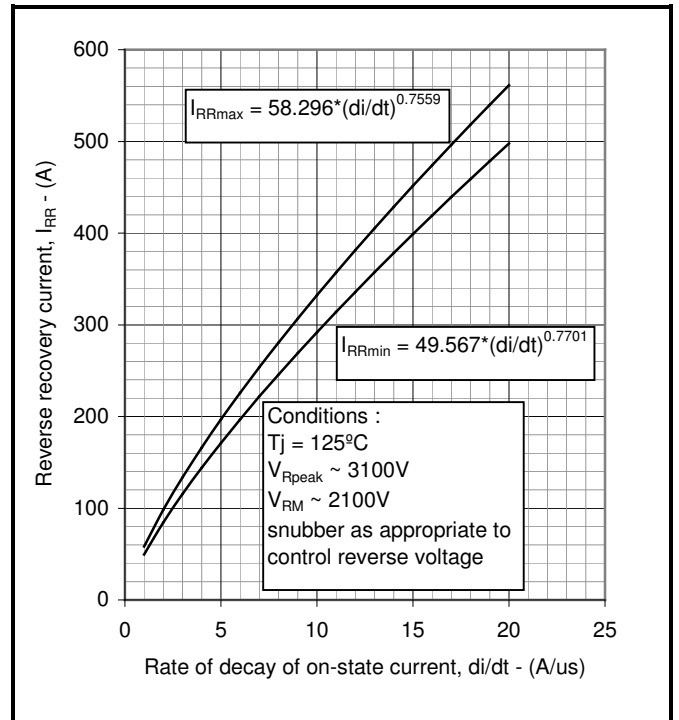

Fig.13 Reverse recovery current

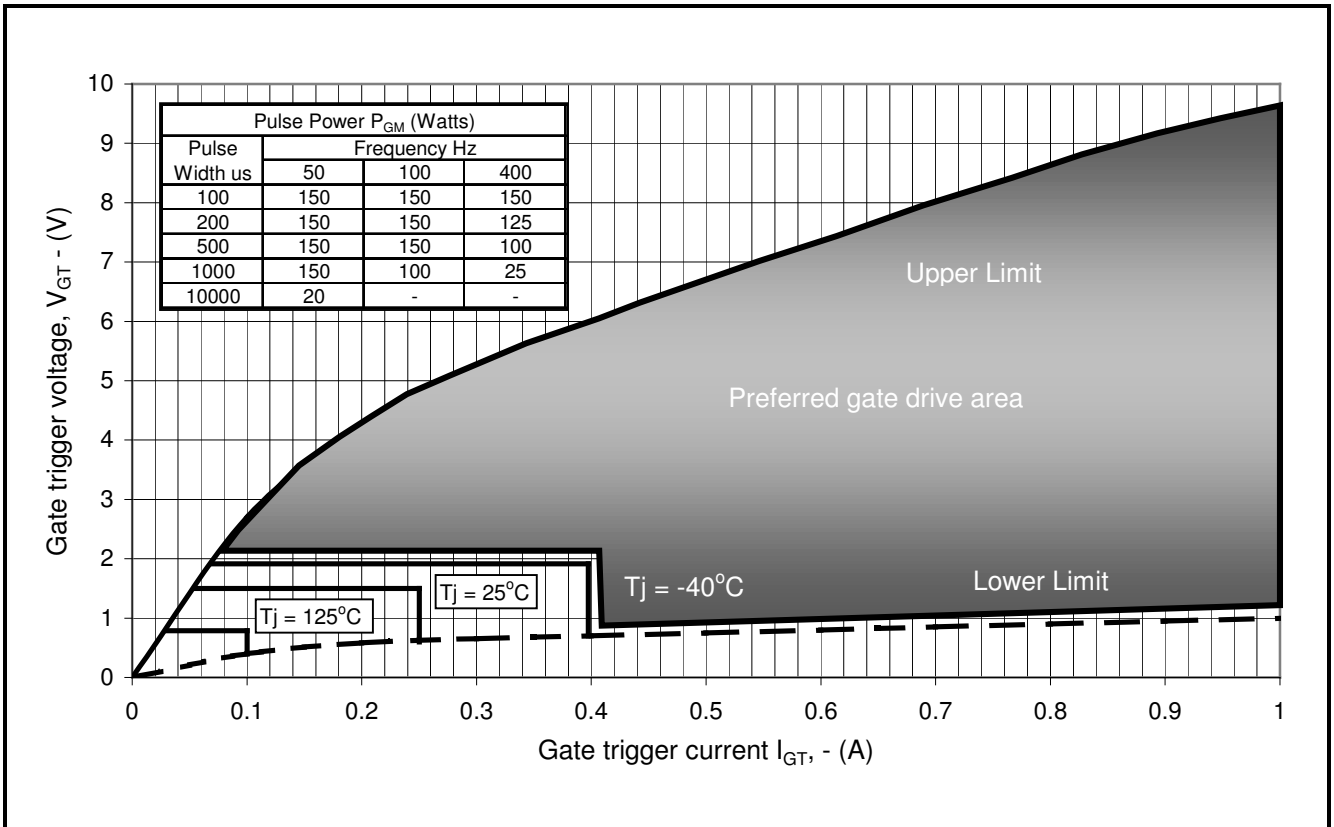

Fig14 Gate Characteristics

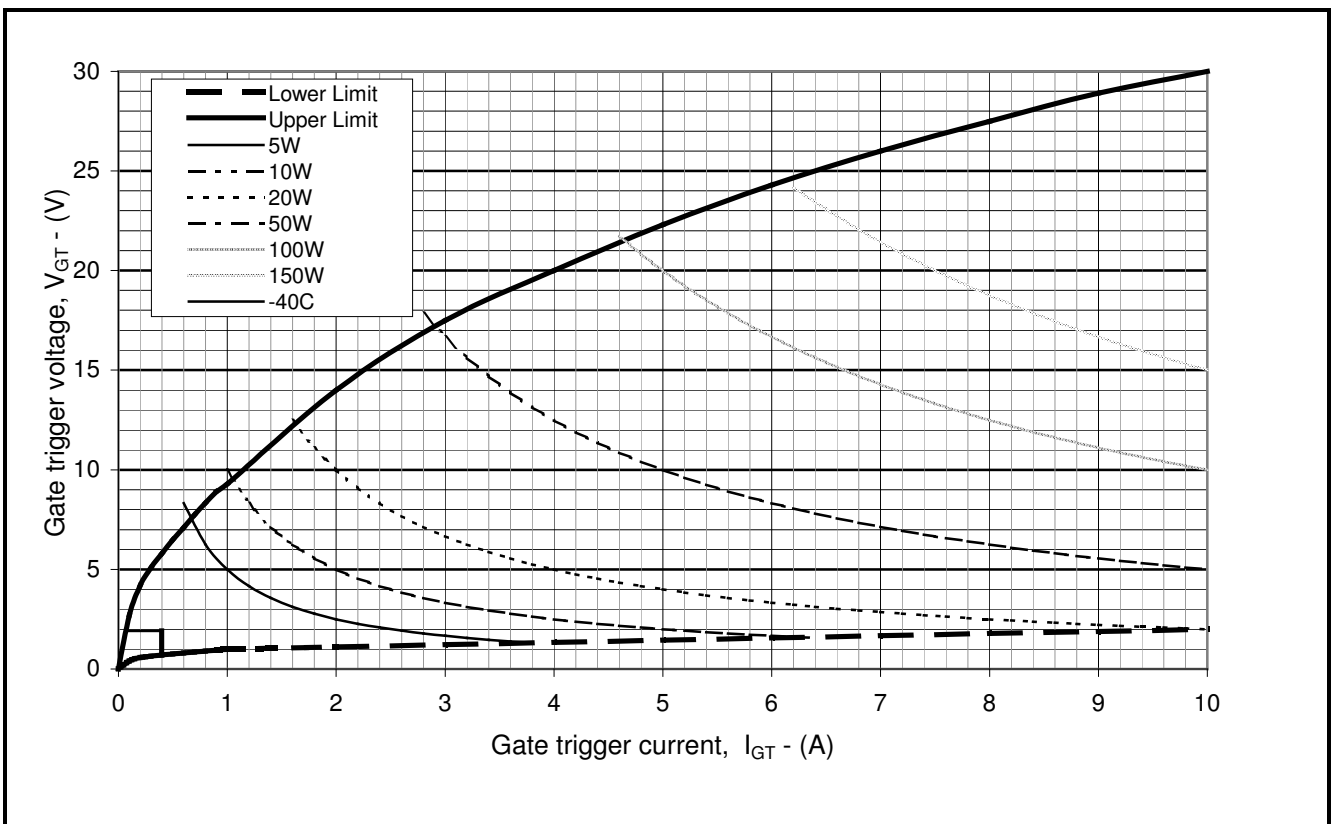

Fig. 15 Gate characteristics

PACKAGE DETAILS

For further package information, please contact Customer Services. All dimensions in mm, unless stated otherwise. DO NOT SCALE.

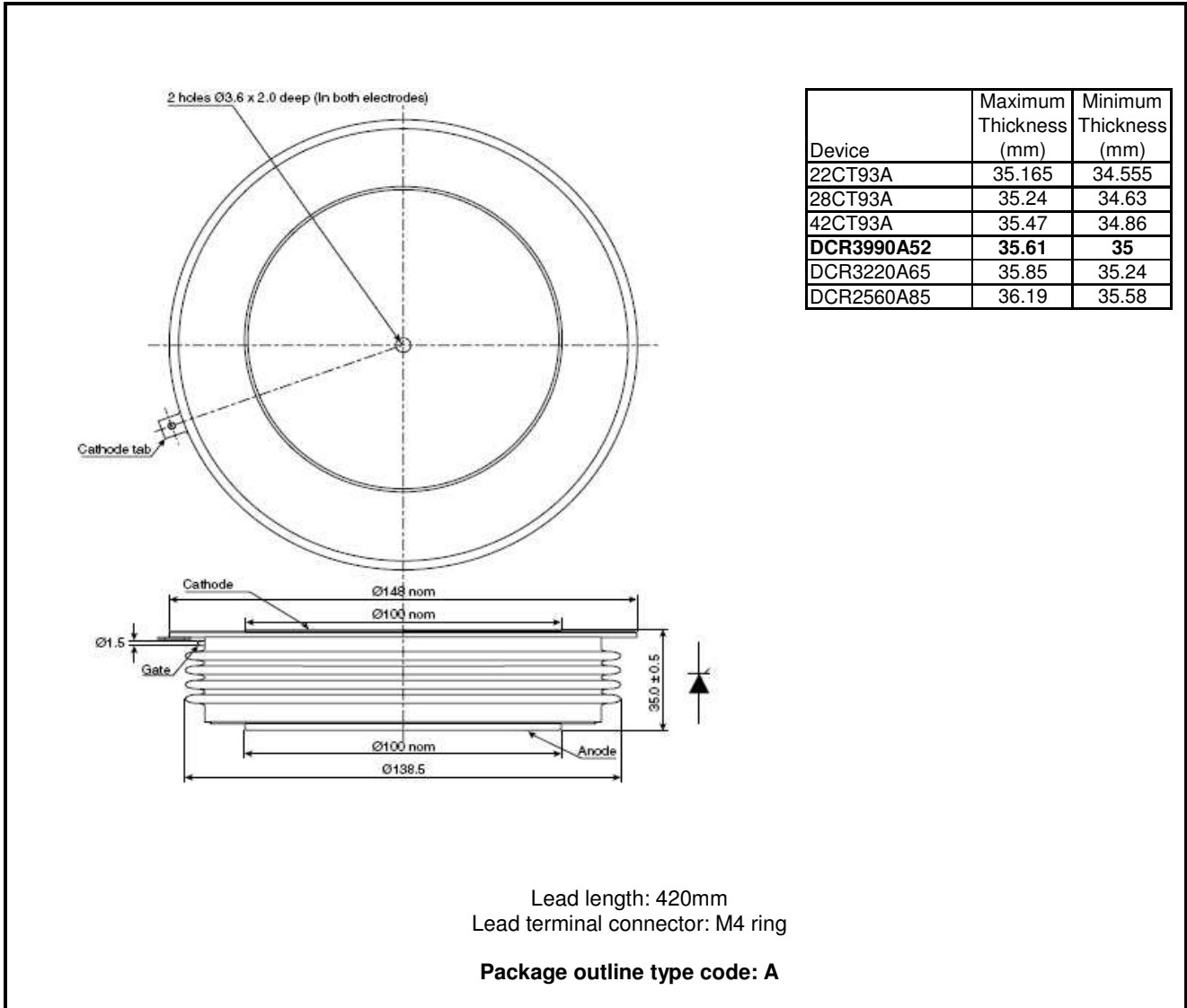

Fig.16 Package outline

POWER ASSEMBLY CAPABILITY

The Power Assembly group was set up to provide a support service for those customers requiring more than the basic semiconductor, and has developed a flexible range of heatsink and clamping systems in line with advances in device voltages and current capability of our semiconductors.

We offer an extensive range of air and liquid cooled assemblies covering the full range of circuit designs in general use today. The Assembly group offers high quality engineering support dedicated to designing new units to satisfy the growing needs of our customers.

Using the latest CAD methods our team of design and applications engineers aim to provide the Power Assembly Complete Solution (PACs).

HEATSINKS

The Power Assembly group has its own proprietary range of extruded aluminium heatsinks which have been designed to optimise the performance of Dynex semiconductors. Data with respect to air natural, forced air and liquid cooling (with flow rates) is available on request.

For further information on device clamps, heatsinks and assemblies, please contact your nearest sales representative or Customer Services.

Stresses above those listed in this data sheet may cause permanent damage to the device. In extreme conditions, as with all semiconductors, this may include potentially hazardous rupture of the package. Appropriate safety precautions should always be followed.



<http://www.dynexsemi.com>

e-mail: power_solutions@dynexsemi.com

**HEADQUARTERS OPERATIONS
DYNEX SEMICONDUCTOR LTD**
Doddington Road, Lincoln
Lincolnshire, LN6 3LF. United Kingdom.
Tel: +44(0)1522 500500
Fax: +44(0)1522 500550

CUSTOMER SERVICE
Tel: +44(0)1522 502753 / 502901. Fax: +44(0)1522 500020

© Dynex Semiconductor 2003 TECHNICAL DOCUMENTATION – NOT FOR
RESALE. PRODUCED IN UNITED KINGDOM.

This publication is issued to provide information only which (unless agreed by the Company in writing) may not be used, applied or reproduced for any purpose nor form part of any order or contract nor to be regarded as a representation relating to the products or services concerned. No warranty or guarantee express or implied is made regarding the capability, performance or suitability of any product or service. The Company reserves the right to alter without prior notice the specification, design or price of any product or service. Information concerning possible methods of use is provided as a guide only and does not constitute any guarantee that such methods of use will be satisfactory in a specific piece of equipment. It is the user's responsibility to fully determine the performance and suitability of any equipment using such information and to ensure that any publication or data used is up to date and has not been superseded. These products are not suitable for use in any medical products whose failure to perform may result in significant injury or death to the user. All products and materials are sold and services provided subject to the Company's conditions of sale, which are available on request.

All brand names and product names used in this publication are trademarks, registered trademarks or trade names of their respective owners.