

DIODE MODULE

DWF(R)70A30/40

DWF(R)70A is a non-isolated diode module designed for 3 phase rectification.

- $I_{F(AV)} = 70A$, $V_{RRM} = 400V$
- Easy Construction with Joint-Cathode (F) Type and Joint-Anode (R) type.
- Non-isolated. (Mounting Base as terminals.)
- High Surge Capability

(Applications)

Welding Power Supply
3 Phase Rectifier

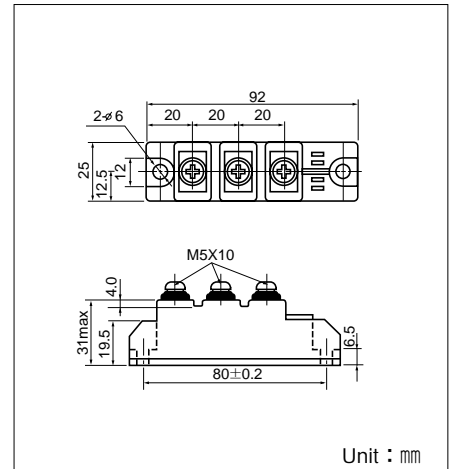
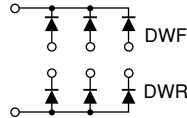

Maximum Ratings

($T_j = 25^\circ C$ unless otherwise specified)

Symbol	Item	Ratings		Unit
		DWF(R)70A30	DWF(R)70A40	
V_{RRM}	Repetitive Peak Reverse Voltage	300	400	V
V_{RSM}	Non-Repetitive Peak Reverse Voltage	360	480	V
$V_{R(DC)}$	D.C. Reverse Voltage	240	320	V

Symbol	Item	Conditions	Ratings	Unit	
$I_{F(AV)}$	Average Forward Current	Single phase, half wave, 180° conduction, $T_c : 119^\circ C$	70	A	
$I_{F(RMS)}$	R.M.S. Forward Current	Single phase, half wave, 180° conduction, $T_c : 119^\circ C$	110	A	
I_{FSM}	Surge Forward Current	$\frac{1}{2}$ cycle, 60Hz, peak value, non-repetitive	1400	A	
I^2t	I^2t	Value for one cycle of surge current	8100	A ² S	
T_j	Operating Junction Temperature		-30 to +150	$^\circ C$	
T_{stg}	Storage Temperature		-30 to +125	$^\circ C$	
	Mounting Torque	Mounting (M5)	Recommended Value 1.5-2.5 (15-25)	2.7 (48)	N·m (kgf·cm)
		Terminal (M5)	Recommended Value 1.5-2.5 (15-25)	2.7 (48)	
	Mass			170	g

Electrical Characteristics

Symbol	Item	Conditions	Ratings	Unit
I_{RRM}	Repetitive Peak Reverse Current, max.	at V_{DRM} , single phase, half wave, $T_j = 150^\circ C$	12	mA
V_{FM}	Forward Voltage Drop, max.	Forward current 220A, $T_j = 25^\circ C$, Inst. measurement	1.15	V
$R_{th(j-c)}$	Thermal Impedance, max.	Junction to case	0.40	$^\circ C/W$

