

# High Power Thyristor Modules

$I_{TRMS} = 880 \text{ A}$   
 $I_{T(AV)M} = 560 \text{ A}$   
 $V_{RRM} = 1200-1800 \text{ V}$

$V_{RSM}$	$V_{RRM}$	Type
$V_{DSM}$	$V_{DRM}$	
V	V	
1300	1200	MCO 500-12io1
1500	1400	MCO 500-14io1
1700	1600	MCO 500-16io1
1900	1800	MCO 500-18io1

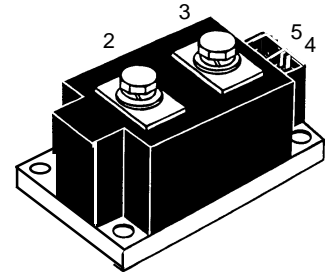
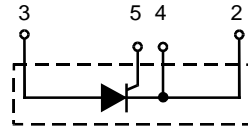

Symbol	Test Conditions	Maximum Ratings	
$I_{TRMS}$	$T_{VJ} = T_{VJM}$	880	A
$I_{T(AV)M}$	$T_C = 85^\circ\text{C}; 180^\circ \text{ sine}$	560	A
$I_{TSM}$	$T_{VJ} = 45^\circ\text{C}$	$t = 10 \text{ ms (50 Hz)}$	17000 A
	$V_R = 0$	$t = 8.3 \text{ ms (60 Hz)}$	16000 A
	$T_{VJ} = T_{VJM}$	$t = 10 \text{ ms (50 Hz)}$	13000 A
	$V_R = 0$	$t = 8.3 \text{ ms (60 Hz)}$	14400 A
$I^2t$	$T_{VJ} = 45^\circ\text{C}$	$t = 10 \text{ ms (50 Hz)}$	1445000 $A^2s$
	$V_R = 0$	$t = 8.3 \text{ ms (60 Hz)}$	1062000 $A^2s$
	$T_{VJ} = T_{VJM}$	$t = 10 \text{ ms (50 Hz)}$	845000 $A^2s$
	$V_R = 0$	$t = 8.3 \text{ ms (60 Hz)}$	813000 $A^2s$
$(di/dt)_{cr}$	$T_{VJ} = T_{VJM}$ repetitive, $I_T = 960 \text{ A}$	$f = 50 \text{ Hz}, t_p = 200 \mu\text{s}$	100 $A/\mu\text{s}$
	$V_D = 2/3 V_{DRM}$	$I_G = 1 \text{ A},$ non repetitive, $I_T = I_{T(AV)M}$	500 $A/\mu\text{s}$
	$di_G/dt = 1 \text{ A}/\mu\text{s}$		
$(dv/dt)_{cr}$	$T_{VJ} = T_{VJM}; V_{DR} = 2/3 V_{DRM}$		1000 $V/\mu\text{s}$
	$R_{GK} = \infty;$ method 1 (linear voltage rise)		
$P_{GM}$	$T_{VJ} = T_{VJM}$	$t_p = 30 \mu\text{s}$	120 W
	$I_T = I_{T(AV)M}$	$t_p = 500 \mu\text{s}$	60 W
$P_{GAV}$			30 W
$V_{RGM}$			10 V
$T_{VJ}$		-40...140	$^\circ\text{C}$
$T_{VJM}$		140	$^\circ\text{C}$
$T_{stg}$		-40...125	$^\circ\text{C}$
$V_{ISOL}$	50/60 Hz, RMS $t = 1 \text{ min}$	3000	V~
	$I_{ISOL} \leq 1 \text{ mA}$ $t = 1 \text{ s}$	3600	V~
$M_d$	Mounting torque (M6)	4.5-7/40-62	Nm/lb.in.
	Terminal connection torque (M8)	11-13/97-115	Nm/lb.in.
Weight	Typical including screws	650	g

## Features

- International standard package
- Direct copper bonded  $\text{Al}_2\text{O}_3$ -ceramic with copper base plate
- Planar passivated chips
- Isolation voltage 3600 V~
- UL registered E 72873
- Keyed gate/cathode twin pins

## Applications

- Motor control, softstarter
- Power converter
- Heat and temperature control for industrial furnaces and chemical processes
- Lighting control
- Solid state switches

## Advantages

- Simple mounting
- Improved temperature and power cycling
- Reduced protection circuits

Data according to IEC 60747 refer to a single thyristor/diode unless otherwise stated. IXYS reserves the right to change limits, test conditions and dimensions

Symbol	Test Conditions	Characteristic Values	
$I_{RRM}$	$T_{VJ} = T_{VJM}; V_R = V_{RRM}$	40	mA
$V_T$	$I_T = 1200 \text{ A}; T_{VJ} = 25^\circ\text{C}$	1.3	V
$V_{T0}$	For power-loss calculations only ( $T_{VJ} = T_{VJM}$ )	0.8	V
$r_T$		0.38	m $\Omega$
$V_{GT}$	$V_D = 6 \text{ V}; T_{VJ} = 25^\circ\text{C}$	2	V
	$T_{VJ} = -40^\circ\text{C}$	3	V
$I_{GT}$	$V_D = 6 \text{ V}; T_{VJ} = 25^\circ\text{C}$	300	mA
	$T_{VJ} = -40^\circ\text{C}$	400	mA
$V_{GD}$	$T_{VJ} = T_{VJM}; V_D = 2/3 V_{DRM}$	0.25	V
$I_{GD}$	$T_{VJ} = T_{VJM}; V_D = 2/3 V_{DRM}$	10	mA
$I_L$	$T_{VJ} = 25^\circ\text{C}; V_D = 6 \text{ V}; t_p = 30 \mu\text{s}$ $di_G/dt = 1 \text{ A}/\mu\text{s}; I_G = 1 \text{ A}$	400	mA
$I_H$	$T_{VJ} = 25^\circ\text{C}; V_D = 6 \text{ V}; R_{GK} = \infty$	300	mA
$t_{gd}$	$T_{VJ} = 25^\circ\text{C}; V_D = 1/2 V_{DRM}$ $di_G/dt = 1 \text{ A}/\mu\text{s}; I_G = 1 \text{ A}$	2	$\mu\text{s}$
$t_q$	$T_{VJ} = T_{VJM}; V_R = 100 \text{ V}; V_D = 2/3 V_{DRM}; t_p = 200 \mu\text{s}$ $dv/dt = 50 \text{ V}/\mu\text{s}; I_T = 500 \text{ A}; -di/dt = 10 \text{ A}/\mu\text{s}$	typ. 350	$\mu\text{s}$
$R_{thJC}$	DC current	0.072	K/W
$R_{thJK}$	DC current	0.096	K/W
$d_s$	Creeping distance on surface	12.7	mm
$d_A$	Creepage distance in air	9.6	mm
$a$	Maximum allowable acceleration	50	m/s <sup>2</sup>

Optional accessories for modules

Keyed Gate/Cathode twin plugs with wire length = 350 mm, gate = yellow, cathode = red

Type **ZY 180 L** (L = Left for pin pair 4/5)  $\left\{ \begin{array}{l} \text{UL 758, style 1385,} \\ \text{CSA class 5851, guide 460-1-1} \end{array} \right.$

Dimensions in mm (1 mm = 0.0394")

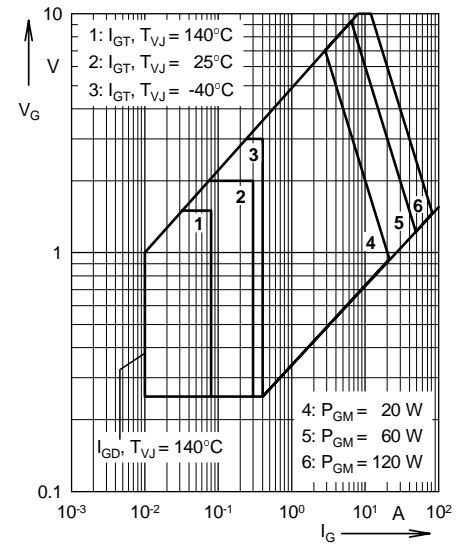
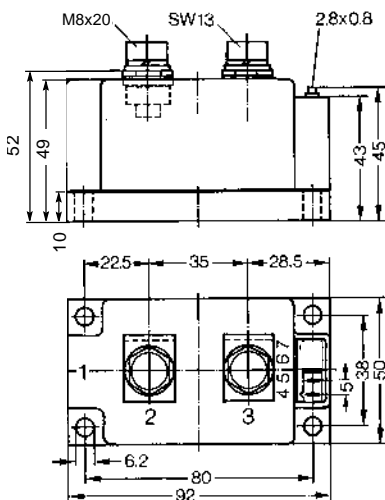

Fig. 1 Gate trigger characteristics

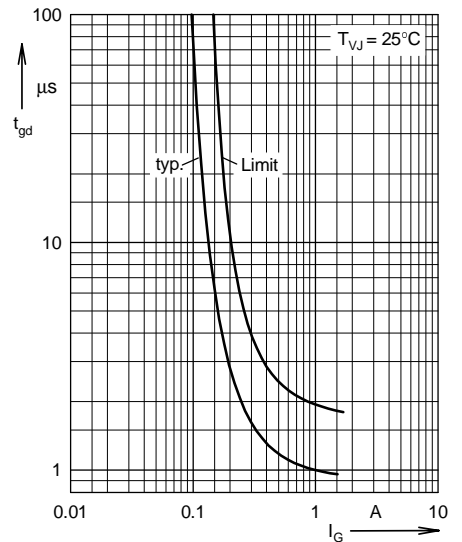

Fig. 2 Gate trigger delay time

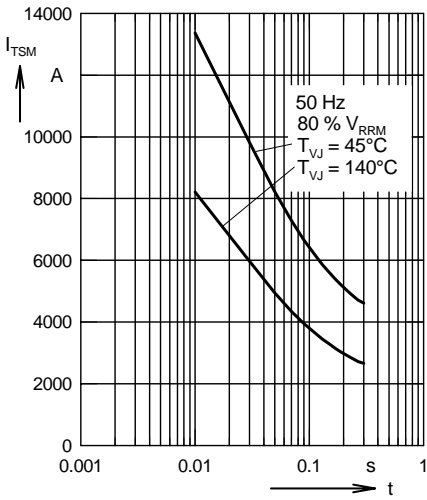

Fig. 3 Surge overload current  
 $I_{TSM}$ ,  $I_{FSM}$ : Crest value, t: duration

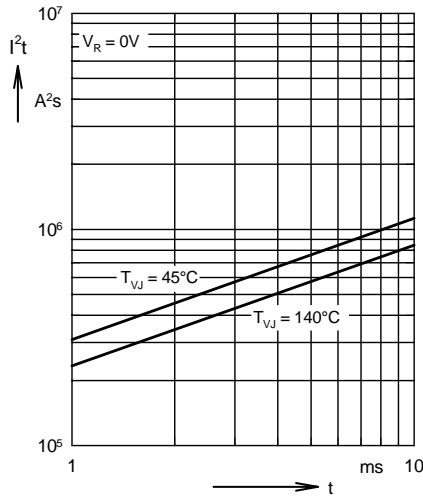

Fig. 4  $\int i^2 dt$  versus time (1-10 ms)

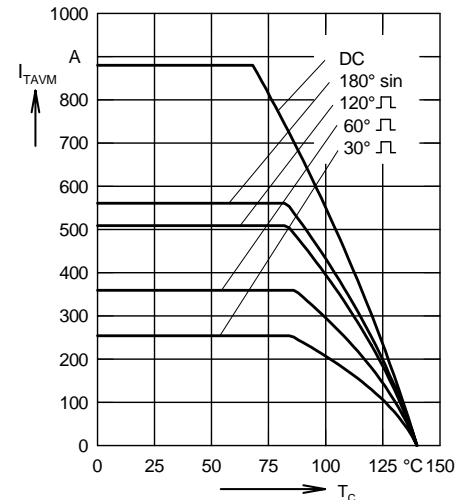

Fig. 5 Maximum forward current at case temperature

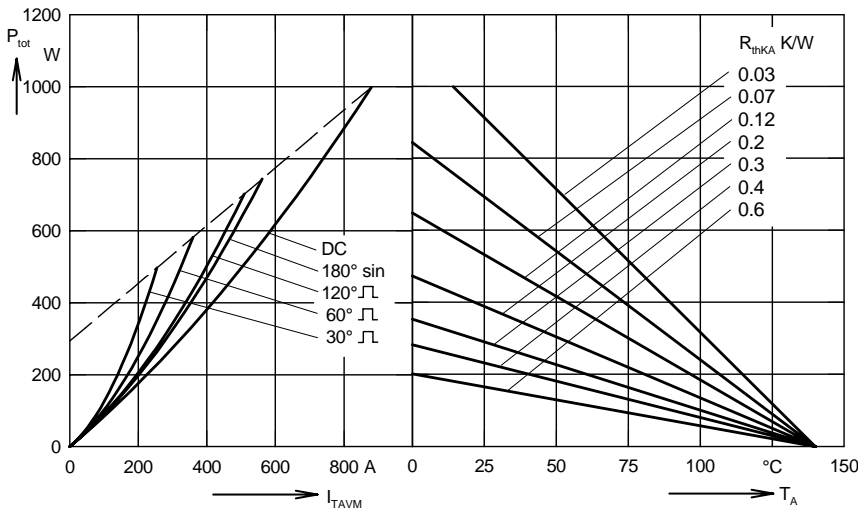

Fig. 6 Power dissipation versus on-state current and ambient temperature

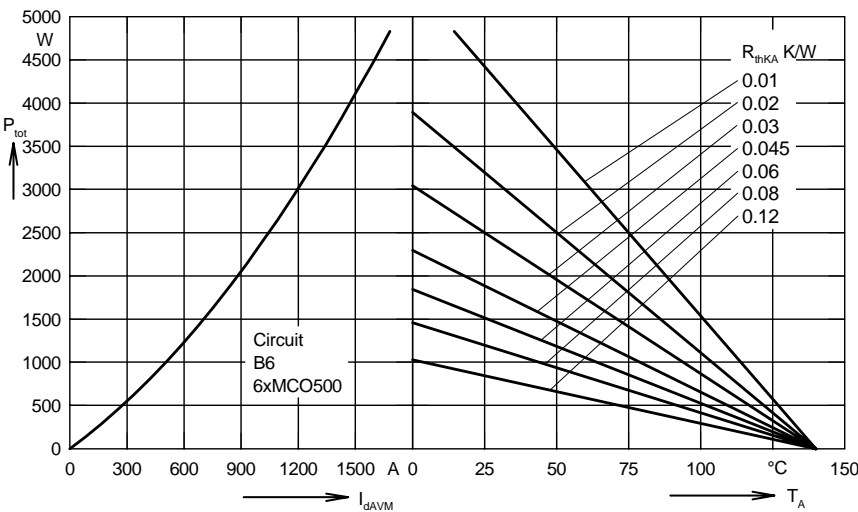

Fig. 7 Three phase rectifier bridge:  
 Power dissipation versus direct output current and ambient temperature

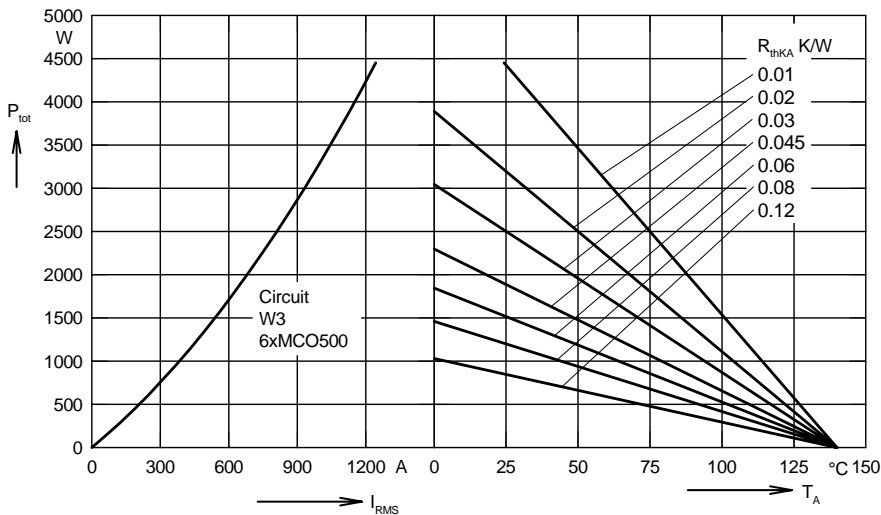

Fig. 8 Three phase AC-controller: Power dissipation versus RMS output current and ambient temperature

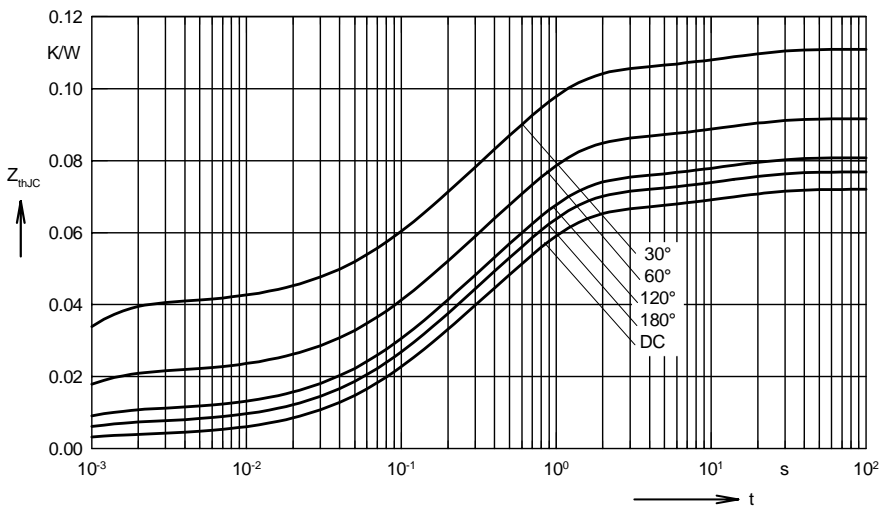

Fig. 9 Transient thermal impedance junction to case (per thyristor)

$R_{thJC}$  for various conduction angles  $d$ :

$d$	$R_{thJC}$ (K/W)
DC	0.072
180°	0.0768
120°	0.081
60°	0.092
30°	0.111

Constants for  $Z_{thJC}$  calculation:

$i$	$R_{thi}$ (K/W)	$t_i$ (s)
1	0.0035	0.0054
2	0.0186	0.098
3	0.0432	0.54
4	0.0067	12

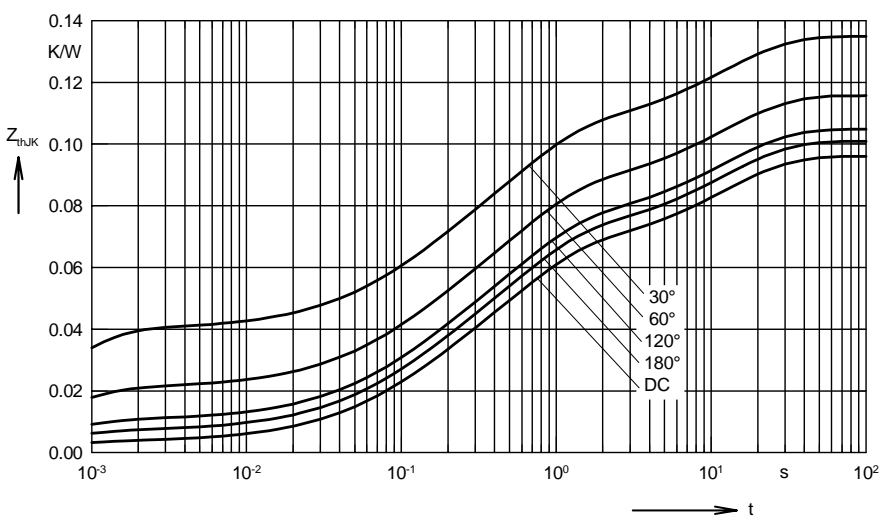

Fig.10 Transient thermal impedance junction to heatsink (per thyristor)

$R_{thJK}$  for various conduction angles  $d$ :

$d$	$R_{thJK}$ (K/W)
DC	0.096
180°	0.1
120°	0.105
60°	0.116
30°	0.135

Constants for  $Z_{thJK}$  calculation:

$i$	$R_{thi}$ (K/W)	$t_i$ (s)
1	0.0035	0.0054
2	0.0186	0.098
3	0.0432	0.54
4	0.0067	12
5	0.024	12