Netz-Thyristor
Phase Control Thyristor
T 1500 N 12...18
Elektrische Eigenschaften / Electrical properties
 Höchstzulässige Werte / Maximum rated values

Periodische Vorwärts- und Rückwärts-Spitzensperrspannung repetitive peak forward off-state and reverse voltages	$T_{vj} = -40^{\circ}\text{C} \dots T_{vj \max}$	$V_{\text{DRM}}, V_{\text{RRM}}$	1200 1600	1400 1800	V V
Vorwärts-Stoßspitzensperrspannung non-repetitive peak forward off-state voltage	$T_{vj} = -40^{\circ}\text{C} \dots T_{vj \max}$	V_{DSM}	1200 1600	1400 1800	V V
Rückwärts-Stoßspitzensperrspannung non-repetitive peak reverse voltage	$T_{vj} = +25^{\circ}\text{C} \dots T_{vj \max}$	V_{RSM}	1300 1700	1500 1900	V V
Durchlaßstrom-Grenzeffektivwert maximum RMS on-state current		I_{TRMSM}		3500	A
Dauergrenzstrom average on-state current	$T_{\text{C}} = 85^{\circ}\text{C}$ $T_{\text{C}} = 54^{\circ}\text{C}$	I_{TAVM}		1500 2228	A A
Stoßstrom-Grenzwert surge current	$T_{vj} = 25^{\circ}\text{C}, t_p = 10 \text{ ms}$ $T_{vj} = T_{vj \max}, t_p = 10 \text{ ms}$	I_{TSM}		39000 35000	A 1) A
Grenzlastintegral I^2t -value	$T_{vj} = 25^{\circ}\text{C}, t_p = 10 \text{ ms}$ $T_{vj} = T_{vj \max}, t_p = 10 \text{ ms}$	I^2t		7606 5611	$10^3 \text{ A}^2\text{s}$ $10^3 \text{ A}^2\text{s}$
Kritische Stromsteilheit critical rate of rise of on-state current	DIN IEC 747-6 $f = 50 \text{ Hz}, i_{\text{GM}} = 1 \text{ A}, di_{\text{G}}/dt = 1 \text{ A}/\mu\text{s}$	$(di_{\text{T}}/dt)_{\text{cr}}$		200	A/ μs
Kritische Spannungssteilheit critical rate of rise of off-state voltage	$T_{vj} = T_{vj \max}, V_{\text{D}} = 0,67 V_{\text{DRM}}$ 5.Kennbuchstabe / 5 th letter F	$(dv_{\text{D}}/dt)_{\text{cr}}$		1000	V/ μs

Charakteristische Werte / Characteristic values

Durchlaßspannung on-state voltage	$T_{vj} = T_{vj \max}, i_{\text{T}} = 7 \text{ kA}$ $T_{vj} = T_{vj \max}, i_{\text{T}} = 1,5 \text{ kA}$	V_{T}	max. 2,10 max. 1,13	V V
Schleusenspannung threshold voltage	$T_{vj} = T_{vj \max}$	$V_{(\text{TO})}$	0,9	V
Ersatzwiderstand slope resistance	$T_{vj} = T_{vj \max}$	r_{T}	0,15	m Ω
Durchlaßkennlinie on-state characteristic $v_{\text{T}} = A + B \cdot i_{\text{T}} + C \cdot \ln(i_{\text{T}} + 1) + D \cdot \sqrt{i_{\text{T}}}$	$T_{vj} = T_{vj \max}$	A= B= C= D=	3,027E-01 1,696E-04 9,303E-02 -2,552E-03	
Zündstrom gate trigger current	$T_{vj} = 25^{\circ}\text{C}, V_{\text{D}} = 6 \text{ V}$	I_{GT}	max. 250	mA
Zündspannung gate trigger voltage	$T_{vj} = 25^{\circ}\text{C}, V_{\text{D}} = 6 \text{ V}$	V_{GT}	max. 2	V
Nicht zündender Steuerstrom gate non-trigger current	$T_{vj} = T_{vj \max}, V_{\text{D}} = 6 \text{ V}$ $T_{vj} = T_{vj \max}, V_{\text{D}} = 0,5 V_{\text{DRM}}$	I_{GD}	max. 10 max. 5	mA mA
Nicht zündende Steuerspannung gate non-trigger voltage	$T_{vj} = T_{vj \max}, V_{\text{D}} = 0,5 V_{\text{DRM}}$	V_{GD}	max. 0,2	V
Haltestrom holding current	$T_{vj} = 25^{\circ}\text{C}, V_{\text{D}} = 6 \text{ V}, R_{\text{A}} = 5 \Omega$	I_{H}	max. 500	mA
Einraststrom latching current	$T_{vj} = 25^{\circ}\text{C}, V_{\text{D}} = 6 \text{ V}, R_{\text{GK}} \geq 10 \Omega$ $i_{\text{GM}} = 1 \text{ A}, di_{\text{G}}/dt = 1 \text{ A}/\mu\text{s}, t_{\text{g}} = 20 \mu\text{s}$	I_{L}	max. 2500	mA
Vorwärts- und Rückwärts-Sperrstrom forward off-state and reverse current	$T_{vj} = T_{vj \max}$ $V_{\text{D}} = V_{\text{DRM}}, V_{\text{R}} = V_{\text{RRM}}$	$i_{\text{D}}, i_{\text{R}}$	max. 150	mA
Zündverzögerung gate controlled delay time	DIN IEC 747-6 $T_{vj} = 25^{\circ}\text{C}, i_{\text{GM}} = 1 \text{ A}, di_{\text{G}}/dt = 1 \text{ A}/\mu\text{s}$	t_{gd}	max. 4	μs

1) Gehäusegrenzstrom 36 kA (50 Hz Sinushalbwellen) / peak case non-rupture current 36 kA (50 Hz sinusoidal half-wave).

prepared by:	Zellerhoff	date of publication:	13.02.01
approved by:	J. Novotny	revision:	1

N**Datenblatt / Data sheet****eupec****Netz-Thyristor
Phase Control Thyristor****T 1500 N 12...18****Elektrische Eigenschaften / Electrical properties**
Charakteristische Werte / Characteristic values

Freiwerdezeit circuit commutated turn-off time	$T_{vj} = T_{vj\ max}$, $i_{TM} = I_{TAVM}$ $V_{RM} = 100\ V$, $v_{DM} = 0,67\ V_{DRM}$ $dv_D/dt = 20\ V/\mu s$, $-di_T/dt = 10\ A/\mu s$ 4.Kennbuchstabe / 4 th letter O	t_q	typ.	240	μs
---	--	-------	------	-----	---------

Thermische Eigenschaften / Thermal properties

Innerer Wärmewiderstand thermal resistance, junction to case	<u>Kühlfläche / cooling surface</u> beidseitig / two-sided, $\theta = 180^\circ\ sin$ beidseitig / two-sided, DC Anode / anode, $\theta = 180^\circ\ sin$ Anode / anode, DC Kathode / cathode, $\theta = 180^\circ\ sin$ Kathode / cathode, DC	R_{thJC}	max.	0,0184	$^\circ C/W$
			max.	0,017	$^\circ C/W$
			max.	0,0344	$^\circ C/W$
			max.	0,033	$^\circ C/W$
			max.	0,0364	$^\circ C/W$
			max.	0,035	$^\circ C/W$
Übergangs-Wärmewiderstand thermal resistance, case to heatsink	<u>Kühlfläche / cooling surface</u> beidseitig / two-sided einseitig / single-sided	R_{thCH}	max.	0,0025	$^\circ C/W$
			max.	0,005	$^\circ C/W$
Höchstzulässige Sperrschichttemperatur maximum junction temperature		$T_{vj\ max}$		125	$^\circ C$
Betriebstemperatur operating temperature		$T_{c\ op}$		-40...+125	$^\circ C$
Lagertemperatur storage temperature		T_{stg}		-40...+150	$^\circ C$

Mechanische Eigenschaften / Mechanical properties

Gehäuse, siehe Anlage case, see annex				Seite 3 page 3	
Si-Element mit Druckkontakt Si-pellet with pressure contact					
Anpresskraft clamping force		F		24...56	kN
Gewicht weight		G	typ.	540	g
Kriechstrecke creepage distance				30	mm
Feuchtekategorie humidity classification	DIN 40040			C	
Schwingfestigkeit vibration resistance	f = 50 Hz			50	m/s^2

Mit diesem Datenblatt werden Halbleiterbauelemente spezifiziert, jedoch keine Eigenschaften zugesichert. Sie gilt in Verbindung mit den zugehörigen technischen Erläuterungen.

This data sheet specifies semiconductor devices, but promises no characteristics. It is valid in combination with the belonging technical notes.

N

Datenblatt / Data sheet

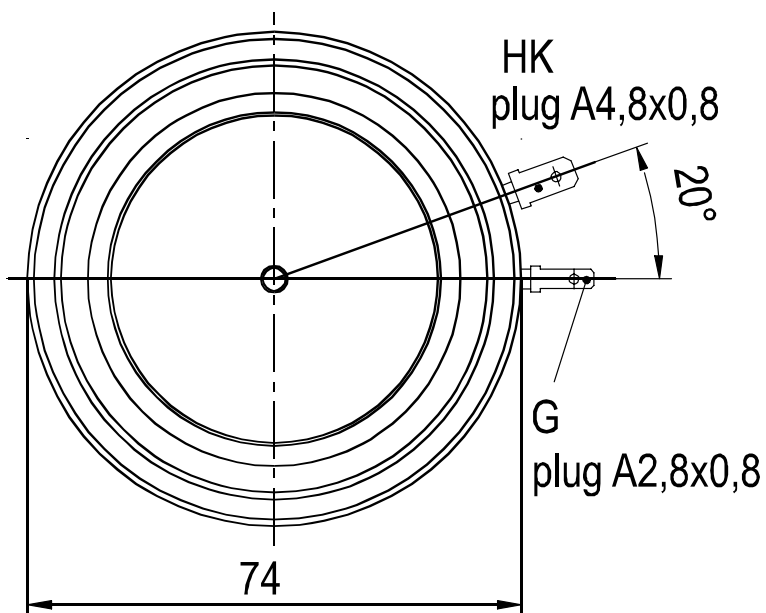
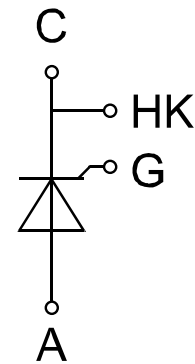
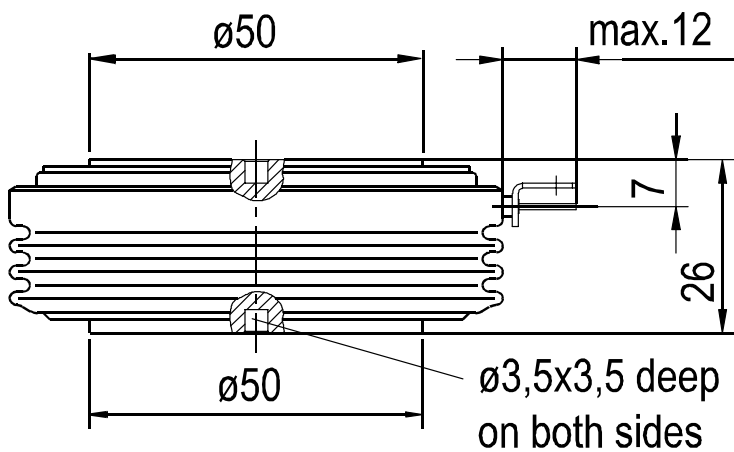
eupec
 Netz-Thyristor
 Phase Control Thyristor
T 1500 N 12...18

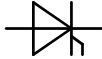

Netz-Thyristor
Phase Control Thyristor

T 1500 N 12...18

	Analytische Elemente des transienten Wärmewiderstandes Z_{thJC} für DC Analytical elements of transient thermal impedance Z_{thJC} for DC							
	Pos. n	1	2	3	4	5	6	7
beidseitig two-sided	R_{thn} [°C/W]	0,00022	0,0011	0,00102	0,00283	0,00608	0,00575	
	τ_n [s]	0,00136	0,00306	0,0139	0,0662	0,512	1,49	
anodenseitig anode-sided	R_{thn} [°C/W]	0,00065	0,0019	0,00239	0,00381	0,00425	0,02	
	τ_n [s]	0,0016	0,0091	0,0791	0,26	1,736	7,21	
kathodenseitig cathode-sided	R_{thn} [°C/W]	0,00055	0,00206	0,00604	0,00551	0,02084		
	τ_n [s]	0,0014	0,00857	0,154	2,58	7,007		

Analytische Funktion / Analytical function:
$$Z_{thJC} = \sum_{n=1}^{n_{max}} R_{thn} \left(1 - e^{-\frac{t}{\tau_n}} \right)$$

Kühler heatsink K0.05F natürliche Luftkühlung natural air-cooling $P_{AV} = xxx$ W	Analytische Elemente des transienten Wärmewiderstandes Z_{thCA} Analytical elements of transient thermal impedance Z_{thCA}							
	Pos. n	1	2	3	4	5	6	7
R_{thn} [°C/W]	0,0008	0,0223	0,0125	0,2094				
τ_n [s]	1,27	10,36	655	1338				

Kühler heatsink K0.05F verstärkte Luftkühlung forced air-cooling $v_L = 120$ l/s	Analytische Elemente des transienten Wärmewiderstandes Z_{thCA} Analytical elements of transient thermal impedance Z_{thCA}							
	Pos. n	1	2	3	4	5	6	7
R_{thn} [°C/W]	0,003	0,021	0,034					
τ_n [s]	2,7	12	209					

Analytische Funktion / Analytical function:
$$Z_{thCA} = \sum_{n=1}^{n_{max}} R_{thn} \left(1 - e^{-\frac{t}{\tau_n}} \right)$$

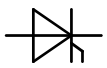
N		Datenblatt / Data sheet	eupec
Netz-Thyristor Phase Control Thyristor		T 1500 N 12...18	
<p>Grenzdurchlaßkennlinie / Limiting on-state characteristic $i_T = f(v_T)$</p> <p>$T_{vj} = T_{vj \text{ max}}$</p>			
MA4 BE / 23 Jul 1992, H.G. Zellerhoff	A15/92	Seite/page	5/4

N		Datenblatt / Data sheet	eupec
Netz-Thyristor Phase Control Thyristor		T 1500 N 12...18	
<p style="text-align: center;">Durchlaßverlustleistung / on-state power loss $P_{TAV} = f(I_{TAV})$</p> <p style="text-align: center;">Sinusförmiger Strom / sinusoidal current</p> <p style="text-align: center;">Parameter: Stromflußwinkel Θ / current conduction angle Θ</p>			
MA4 BE / 23 Jul 1992, H.G. Zellerhoff	A15/92	Seite/page	6/4

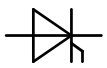
N		Datenblatt / Data sheet	eupec
Netz-Thyristor Phase Control Thyristor		T 1500 N 12...18	
<p>Höchstzulässige Gehäusetemperatur / Maximum allowable case temperature $T_C = f(I_{TAVM})$</p> <p>Sinusförmiger Strom / sinusoidal current</p> <p>Beidseitige Kühlung / Two-sided cooling</p> <p>Parameter: Stromflußwinkel Θ / current conduction angle Θ</p>			
MA4 BE / 23 Jul 1992, H.G. Zellerhoff	A15/92	Seite/page	7/4

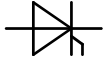
N		Datenblatt / Data sheet	eupec
Netz-Thyristor Phase Control Thyristor		T 1500 N 12...18	
<p>Höchstzulässige Gehäusetemperatur / Maximum allowable case temperature $T_C = f(I_{TAVM})$</p> <p>Sinusförmiger Strom / sinusoidal current</p> <p>Anodenseitige Kühlung / anode-sided cooling</p> <p>Parameter: Stromflußwinkel Θ / current conduction angle Θ</p>			
MA4 BE / 23 Jul 1992, H.G. Zellerhoff	A15/92	Seite/page	8/4

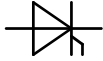
N		Datenblatt / Data sheet	eupec
Netz-Thyristor Phase Control Thyristor		T 1500 N 12...18	
<p>Höchstzulässige Gehäusetemperatur / maximum allowable case temperature $T_C = f(I_{TAVM})$</p> <p>Sinusförmiger Strom / sinusoidal current</p> <p>Kathodenseitige Kühlung / cathode-sided cooling</p> <p>Parameter: Stromflußwinkel Θ / current conduction angle Θ</p>			
MA4 BE / 23 Jul 1992, H.G. Zellerhoff	A15/92	Seite/page	9/4

N		Datenblatt / Data sheet	eupec
Netz-Thyristor Phase Control Thyristor		T 1500 N 12...18	
<p>Höchstzulässige Kühlmitteltemperatur / Max. allowable cooling medium temperature $T_A = f(I_{TAVM})$</p> <p>Sinusförmiger Strom / sinusoidal current</p> <p>Luftselbstkühlung / Natural air-cooling</p> <p>Kühlkörper / Heatsink: K0.05F</p> <p>Parameter: Stromflußwinkel Θ / current conduction angle Θ</p>			
MA4 BE / 23 Jul 1992, H.G. Zellerhoff	A15/92	Seite/page	10/4

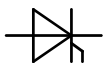
N		Datenblatt / Data sheet	eupec
Netz-Thyristor Phase Control Thyristor		T 1500 N 12...18	
<p>Höchstzulässige Kühlmitteltemperatur / Max. allowable cooling medium temperature $T_A = f(I_{TAVM})$</p> <p>Sinusförmiger Strom / sinusoidal current</p> <p>Verstärkte Luftkühlung / Forced air-cooling</p> <p>Kühlkörper / Heatsink: K0.05F, $T_A = 35\text{ °C}$, $V_L = 120\text{ l/s}$</p> <p>Parameter: Stromflußwinkel Θ / current conduction angle Θ</p>			
MA4 BE / 23 Jul 1992, H.G. Zellerhoff	A15/92	Seite/page	11/4

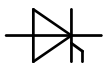
N		Datenblatt / Data sheet	eupec
Netz-Thyristor Phase Control Thyristor		T 1500 N 12...18	
<p>Durchlaßverlustleistung / On-state power loss $P_{TAV} = f(I_{TAV})$</p> <p>Rechteckförmiger Strom / rectangular current</p> <p>Parameter: Stromflußwinkel Θ / current conduction angle Θ</p>			
MA4 BE / 23 Jul 1992, H.G. Zellerhoff	A15/92	Seite/page	12/4

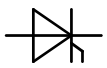
N		Datenblatt / Data sheet	eupec
Netz-Thyristor Phase Control Thyristor		T 1500 N 12...18	
<p style="text-align: center;">Höchstzulässige Gehäusetemperatur / Maximum allowable case temperature $T_C = f(I_{TAVM})$</p> <p style="text-align: center;">Rechteckförmiger Strom / rectangular current</p> <p style="text-align: center;">Beidseitige Kühlung / two-sided cooling</p> <p style="text-align: center;">Parameter: Stromflußwinkel Θ / current conduction angle Θ</p>			
MA4 BE / 23 Jul 1992, H.G. Zellerhoff	A15/92	Seite/page	13/4

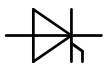
N		Datenblatt / Data sheet	eupec
Netz-Thyristor Phase Control Thyristor		T 1500 N 12...18	
<p>Höchstzulässige Gehäusetemperatur / Maximum allowable case temperature $T_C = f(I_{TAVM})$</p> <p>Rechteckförmiger Strom / rectangular current</p> <p>Anodenseitige Kühlung / anode-sided cooling</p> <p>Parameter: Stromflußwinkel Θ / current conduction angle Θ</p>			
MA4 BE / 23 Jul 1992, H.G. Zellerhoff	A15/92	Seite/page	14/4

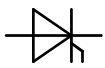
N		Datenblatt / Data sheet	eupec
Netz-Thyristor Phase Control Thyristor		T 1500 N 12...18	
<p style="text-align: center;">Höchstzulässige Gehäusetemperatur / Maximum allowable case temperature $T_C = f(I_{TAVM})$</p> <p style="text-align: center;">Rechteckförmiger Strom / rectangular current</p> <p style="text-align: center;">Kathodenseitige Kühlung / cathode-sided cooling</p> <p style="text-align: center;">Parameter: Stromflußwinkel Θ / current conduction angle Θ</p>			
MA4 BE / 23 Jul 1992, H.G. Zellerhoff	A15/92	Seite/page	15/4

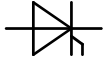
N		Datenblatt / Data sheet	eupec
Netz-Thyristor Phase Control Thyristor		T 1500 N 12...18	
<p>Höchstzulässige Kühlmitteltemperatur / max. allowable cooling medium temperature $T_A = f(I_{TAVM})$</p> <p>Sinusförmiger Strom / sinusoidal current</p> <p>Luftselbstkühlung / Natural air-cooling</p> <p>Kühlkörper / Heatsink: K0.05F</p> <p>Parameter: Stromflußwinkel Θ / current conduction angle Θ</p>			
MA4 BE / 23 Jul 1992, H.G. Zellerhoff	A15/92		Seite/page 16/4

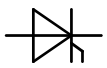
N		Datenblatt / Data sheet	eupec
Netz-Thyristor Phase Control Thyristor		T 1500 N 12...18	
<p style="text-align: center;">Höchstzulässige Kühlmitteltemperatur / Max. allowable cooling medium temperature $T_A = f(I_{TAVM})$</p> <p style="text-align: center;">Sinusförmiger Strom / sinusoidal current</p> <p style="text-align: center;">Verstärkte Luftkühlung / Forced air-cooling</p> <p style="text-align: center;">Kühlkörper / Heatsink: K0.05F, $T_A = 35\text{ °C}$, $V_L = 120\text{ l/s}$</p> <p style="text-align: center;">Parameter: Stromflußwinkel Θ / current conduction angle Θ</p>			
MA4 BE / 23 Jul 1992, H.G. Zellerhoff	A15/92	Seite/page	17/4

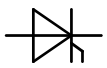
N		Datenblatt / Data sheet	eupec
Netz-Thyristor Phase Control Thyristor		T 1500 N 12...18	
<p>Überstrom / Overload on-state current $I_{T(OV)} = f(t)$</p> <p>Beidseitige natürliche Kühlung / natural two-sided cooling K0.05F</p> <p>Parameter: Vorlaststrom / pre-load current $I_{TAV(vor)}$</p>			
MA4 BE / 23 Jul 1992, H.G. Zellerhoff	A15/92		Seite/page 18/4

N		Datenblatt / Data sheet	eupec
Netz-Thyristor Phase Control Thyristor		T 1500 N 12...18	
<p>Überstrom / Overload on-state current $I_{T(OV)} = f(t)$</p> <p>Beidseitige verstärkte Kühlung / forced two-sided cooling K0.05F</p> <p>$T_A = 35^\circ\text{C}, V_L = 120 \text{ l/s}$</p> <p>Parameter: Vorlaststrom / pre-load current $I_{TAV(vor)}$</p>			
MA4 BE / 23 Jul 1992, H.G. Zellerhoff	A15/92	Seite/page	19/4

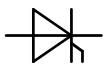
N		Datenblatt / Data sheet	eupec
Netz-Thyristor Phase Control Thyristor		T 1500 N 12...18	
<p>Höchstzulässiger Durchlaßstrom bei Aussetzbetrieb maximum allowable on-state current during intermittent operation $I_{TINT} = f(ED)$</p> <p>Beidseitige verstärkte Kühlung / forced two-sided cooling K0.05F</p> <p>$T_A = 35^{\circ}\text{C}$, $V_L = 120 \text{ l/s}$</p> <p>Parameter: Vorlaststrom / pre-load current $I_{TAV(vor)}$, Spieldauer / cycle duration SD</p>			
MA4 BE / 23 Jul 1992, H.G. Zellerhoff	A15/92	Seite/page	20/4

N		Datenblatt / Data sheet	eupec
Netz-Thyristor Phase Control Thyristor		T 1500 N 12...18	
<p style="text-align: center;">Grenzstrom / Maximum overload on-state current $I_{T(OV)M} = f(t)$, $v_{RM} = 0,8 V_{RRM}$</p> <p style="text-align: center;">Beidseitige Kühlung / two-sided cooling K0.05F</p> <p style="text-align: center;">Belastung aus / Surge current occurs:</p> <p style="text-align: center;">a - Leerlauf / No-load conditions</p> <p style="text-align: center;">b - Betrieb mit Dauergrenzstrom / During operation at max. average on-state current I_{TAVM}</p>			
MA4 BE / 23 Jul 1992, H.G. Zellerhoff	A15/92	Seite/page	21/4

N		Datenblatt / Data sheet	eupec
Netz-Thyristor Phase Control Thyristor		T 1500 N 12...18	
<p> Steuercharakteristik $v_G = f(i_G)$ mit Zündbereichen für $V_D = 6\text{ V}$ Gate characteristic $v_G = f(i_G)$ with triggering area for $V_D = 6\text{ V}$ </p> <p> Höchstzulässige Spitzensteuerverlustleistung / Maximum rated peak gate power dissipation $P_{GM} = f(t_g)$: </p> <p> a - 20 W/10ms b - 40 W/1ms c - 60 W/0,5ms </p>			
MA4 BE / 23 Jul 1992, H.G. Zellerhoff	A15/92		Seite/page 22/4

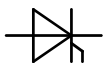
N		Datenblatt / Data sheet	eupec
Netz-Thyristor Phase Control Thyristor		T 1500 N 12...18	
<p>Zündverzug / Gate controlled delay time $t_{gd} = f(i_G)$</p> <p>$T_{vj} = 25^\circ\text{C}, di_G/dt = i_{GM}/1\mu\text{s}$</p> <p>a - maximaler Verlauf / limiting characteristic</p> <p>b - typischer Verlauf / typical characteristic</p>			
MA4 BE / 23 Jul 1992, H.G. Zellerhoff	A15/92	Seite/page	23/4

N		Datenblatt / Data sheet	eupec
Netz-Thyristor Phase Control Thyristor		T 1500 N 12...18	
<p>Sperrverzögerungsladung / Recovered charge $Q_r = f(di/dt)$</p> <p>$t_{vj} = t_{vjmax}, V_R = 0,5 V_{RRM}, V_{RM} = 0,8 V_{RRM}$</p> <p>Parameter: Durchlaßstrom / On-state current i_{TM}</p>			
MA4 BE / 23 Jul 1992, H.G. Zellerhoff	A15/92	Seite/page	24/4

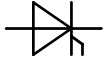
N		Datenblatt / Data sheet	eupec
Netz-Thyristor Phase Control Thyristor		T 1500 N 12...18	
<p>Transienter innerer Wärmewiderstand / transient thermal impedance $Z_{(th)JC} = f(t)$</p> <p>Sinusförmiger Strom / sinusoidal current</p> <p>Beidseitige Kühlung / Two-sided cooling</p> <p>Parameter: Stromflußwinkel Θ / current conduction angle Θ</p>			
MA4 BE / 23 Jul 1992, H.G. Zellerhoff	A15/92	Seite/page	25/4

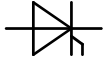
N		Datenblatt / Data sheet	eupec
Netz-Thyristor Phase Control Thyristor		T 1500 N 12...18	
<p>Transienter innerer Wärmewiderstand / transient thermal impedance $Z_{(th)JC} = f(t)$</p> <p>Sinusförmiger Strom / sinusoidal current</p> <p>Anodenseitige Kühlung / anode-sided cooling</p> <p>Parameter: Stromflußwinkel Θ / current conduction angle Θ</p>			
MA4 BE / 23 Jul 1992, H.G. Zellerhoff	A15/92	Seite/page	26/4

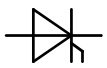
N		Datenblatt / Data sheet	eupec
Netz-Thyristor Phase Control Thyristor		T 1500 N 12...18	
<p style="text-align: center;">Transienter innerer Wärmewiderstand / transient thermal impedance $Z_{(th)JC} = f(t)$</p> <p style="text-align: center;">Sinusförmiger Strom / sinusoidal current</p> <p style="text-align: center;">Kathodenseitige Kühlung / cathode-sided cooling</p> <p style="text-align: center;">Parameter: Stromflußwinkel Θ / current conduction angle Θ</p>			
MA4 BE / 23 Jul 1992, H.G. Zellerhoff	A15/92		Seite/page 27/4

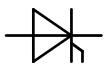
N		Datenblatt / Data sheet	eupec	
Netz-Thyristor Phase Control Thyristor		T 1500 N 12...18		
<p>Transienter innerer Wärmewiderstand / transient thermal impedance $Z_{(th)JC} = f(t)$</p> <p>Rechteckförmiger Strom / rectangular current</p> <p>Beidseitige Kühlung / two-sided cooling</p> <p>Parameter: Stromflußwinkel Θ / current conduction angle Θ</p>				
MA4 BE / 23 Jul 1992, H.G. Zellerhoff	A15/92		Seite/page	28/4

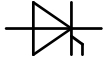
N		Datenblatt / Data sheet	eupec
Netz-Thyristor Phase Control Thyristor		T 1500 N 12...18	
<p>Transienter innerer Wärmewiderstand / transient thermal impedance $Z_{(th)JC} = f(t)$</p> <p>Rechteckförmiger Strom / rectangular current</p> <p>Anodenseitige Kühlung / anode-sided cooling</p> <p>Parameter: Stromflußwinkel Θ / current conduction angle Θ</p>			
MA4 BE / 23 Jul 1992, H.G. Zellerhoff	A15/92	Seite/page	29/4

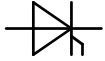
N		Datenblatt / Data sheet	eupec
Netz-Thyristor Phase Control Thyristor		T 1500 N 12...18	
<p style="text-align: center;">Transienter innerer Wärmewiderstand / transient thermal impedance $Z_{(th)JC} = f(t)$</p> <p style="text-align: center;">Rechteckförmiger Strom / rectangular current</p> <p style="text-align: center;">Kathodenseitige Kühlung / cathode-sided cooling</p> <p style="text-align: center;">Parameter: Stromflußwinkel Θ / current conduction angle Θ</p>			
MA4 BE / 23 Jul 1992, H.G. Zellerhoff	A15/92	Seite/page	30/4

Nutzungsbedingungen

Die in diesem Produktdatenblatt enthaltenen Daten sind ausschließlich für technisch geschultes Fachpersonal bestimmt. Die Beurteilung der Geeignetheit dieses Produktes für die von Ihnen anvisierte Anwendung sowie die Beurteilung der Vollständigkeit der bereitgestellten Produktdaten für diese Anwendung obliegt Ihnen bzw. Ihren technischen Abteilungen.

In diesem Produktdatenblatt werden diejenigen Merkmale beschrieben, für die wir eine liefervertragliche Gewährleistung übernehmen. Eine solche Gewährleistung richtet sich ausschließlich nach Maßgabe der im jeweiligen Liefervertrag enthaltenen Bestimmungen. Garantien jeglicher Art werden für das Produkt und dessen Eigenschaften keinesfalls übernommen.

Sollten Sie von uns Produktinformationen benötigen, die über den Inhalt dieses Produktdatenblatts hinausgehen und insbesondere eine spezifische Verwendung und den Einsatz dieses Produktes betreffen, setzen Sie sich bitte mit dem für Sie zuständigen Vertriebsbüro in Verbindung (siehe www.eupec.com, Vertrieb&Kontakt). Für Interessenten halten wir Application Notes bereit.

Aufgrund der technischen Anforderungen könnte unser Produkt gesundheitsgefährdende Substanzen enthalten. Bei Rückfragen zu den in diesem Produkt jeweils enthaltenen Substanzen setzen Sie sich bitte ebenfalls mit dem für Sie zuständigen Vertriebsbüro in Verbindung.

Sollten Sie beabsichtigen, das Produkt in Anwendungen der Luftfahrt, in gesundheits- oder lebensgefährdenden oder lebenserhaltenden Anwendungsbereichen einzusetzen, bitten wir um Mitteilung. Wir weisen darauf hin, dass wir für diese Fälle

- die gemeinsame Durchführung eines Risiko- und Qualitätsassessments;
- den Abschluss von speziellen Qualitätssicherungsvereinbarungen;
- die gemeinsame Einführung von Maßnahmen zu einer laufenden Produktbeobachtung dringend empfehlen und gegebenenfalls die Belieferung von der Umsetzung solcher Maßnahmen abhängig machen.

Soweit erforderlich, bitten wir Sie, entsprechende Hinweise an Ihre Kunden zu geben.

Inhaltliche Änderungen dieses Produktdatenblatts bleiben vorbehalten.

Terms & Conditions of usage

The data contained in this product data sheet is exclusively intended for technically trained staff. You and your technical departments will have to evaluate the suitability of the product for the intended application and the completeness of the product data with respect to such application.

This product data sheet is describing the characteristics of this product for which a warranty is granted. Any such warranty is granted exclusively pursuant the terms and conditions of the supply agreement. There will be no guarantee of any kind for the product and its characteristics.

Should you require product information in excess of the data given in this product data sheet or which concerns the specific application of our product, please contact the sales office, which is responsible for you (see www.eupec.com, sales&contact). For those that are specifically interested we may provide application notes.

Due to technical requirements our product may contain dangerous substances. For information on the types in question please contact the sales office, which is responsible for you.

Should you intend to use the Product in aviation applications, in health or life endangering or life support applications, please notify.

Please note, that for any such applications we urgently recommend

- to perform joint Risk and Quality Assessments;
- the conclusion of Quality Agreements;
- to establish joint measures of an ongoing product survey, and that we may make delivery depended on the realization of any such measures.

If and to the extent necessary, please forward equivalent notices to your customers.

Changes of this product data sheet are reserved.