

MITSUBISHI IGBT MODULES
CM75RL-24NF

HIGH POWER SWITCHING USE

CM75RL-24NF



- IC 75A
- VCES 1200V
- Insulated Type
- 7-elements in a pack

APPLICATION

AC drive inverters & Servo controls, etc

OUTLINE DRAWING & CIRCUIT DIAGRAM

Dimensions in mm

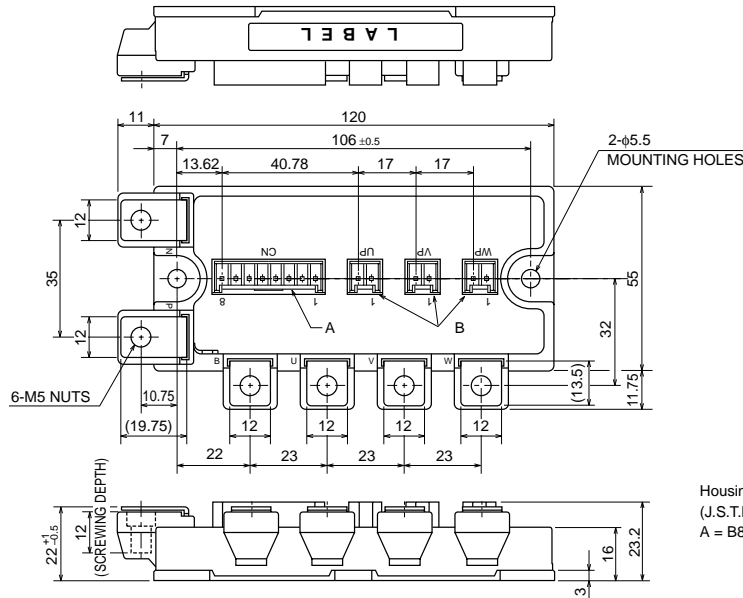

Housing Type of A and B
 (J.S.T.Mfg.Co.Ltd)
 A = B8P-VH-FB-B, B = B2P-VH-FB-B

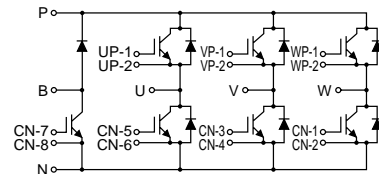

CIRCUIT DIAGRAM

CM75RL-24NF

HIGH POWER SWITCHING USE

ABSOLUTE MAXIMUM RATINGS (T_j = 25°C)
INVERTER PART

| Symbol | Parameter | Conditions | Ratings | Unit |
|--------------------------|-------------------------------|-----------------------------|---------|------|
| V _{CES} | Collector-emitter voltage | G-E Short | 1200 | V |
| V _{GES} | Gate-emitter voltage | C-E Short | ±20 | V |
| I _C | Collector current | DC, T _C = 87°C*1 | 75 | A |
| I _{CM} | | Pulse (Note 2) | 150 | A |
| I _E (Note 1) | Emitter current | | 75 | A |
| I _{EM} (Note 1) | | Pulse (Note 2) | 150 | A |
| P _C (Note 3) | Maximum collector dissipation | T _C = 25°C | 520 | W |

BRAKE PART

| Symbol | Parameter | Conditions | Ratings | Unit |
|-------------------------|---------------------------------|-----------------------------|---------|------|
| V _{CES} | Collector-emitter voltage | G-E Short | 1200 | V |
| V _{GES} | Gate-emitter voltage | C-E Short | ±20 | V |
| I _C | Collector current | DC, T _C = 94°C*1 | 50 | A |
| I _{CM} | | Pulse (Note 2) | 100 | A |
| P _C (Note 3) | Maximum collector dissipation | T _C = 25°C | 390 | W |
| V _{RRM} | Repetitive peak reverse voltage | Clamp diode part | 1200 | V |
| I _{FM} | Forward current | Clamp diode part | 50 | A |

(COMMON RATING)

| Symbol | Parameter | Conditions | Ratings | Unit |
|------------------|----------------------|--|------------|-------|
| T _j | Junction temperature | | -40 ~ +150 | °C |
| T _{stg} | Storage temperature | | -40 ~ +125 | °C |
| V _{iso} | Isolation voltage | Main Terminal to base plate, AC 1 min. | 2500 | V |
| — | Torque strength | Main Terminal M5 | 2.5 ~ 3.5 | N • m |
| — | | Mounting holes M5 | 2.5 ~ 3.5 | N • m |
| — | Weight | Typical value | 350 | g |

CM75RL-24NF

HIGH POWER SWITCHING USE

ELECTRICAL CHARACTERISTICS (T_J = 25°C)
INVERTER PART

| Symbol | Parameter | Test conditions | Limits | | | Unit |
|--------------------------|--------------------------------------|--|--------|-------|------|------|
| | | | Min. | Typ. | Max. | |
| ICES | Collector cutoff current | VCE = VCES, VGE = 0V | — | — | 1 | mA |
| VGE(th) | Gate-emitter threshold voltage | IC = 7.5mA, VCE = 10V | 6 | 7 | 8 | V |
| IGES | Gate leakage current | VGE = VGES, VCE = 0V | — | — | 0.5 | μA |
| VCE(sat) | Collector-emitter saturation voltage | IC = 75A, VGE = 15V | — | 2.1 | 3.0 | V |
| | | T _J = 25°C T _J = 125°C | — | 2.4 | — | |
| Cies | Input capacitance | VCE = 10V VGE = 0V | — | — | 11.5 | nF |
| Coēs | Output capacitance | | — | — | 1.0 | nF |
| Cres | Reverse transfer capacitance | | — | — | 0.23 | nF |
| QG | Total gate charge | VCC = 600V, IC = 75A, VGE = 15V | — | 338 | — | nC |
| td(on) | Turn-on delay time | VCC = 600V, IC = 75A VGE1 = VGE2 = 15V RG = 4.2Ω, Inductive load switching operation IE = 75A | — | — | 100 | ns |
| tr | Turn-on rise time | | — | — | 50 | ns |
| td(off) | Turn-off delay time | | — | — | 300 | ns |
| tf | Turn-off fall time | | — | — | 350 | ns |
| t _{rr} (Note 1) | Reverse recovery time | | — | — | 120 | ns |
| Q _{rr} (Note 1) | Reverse recovery charge | IE = 75A | — | 3 | — | μC |
| VEC(Note 1) | Emitter-collector voltage | IE = 75A, VGE = 0V | — | — | 3.8 | V |
| R _{th(j-c)Q} | Thermal resistance | IGBT part (1/6 module) ^{*1} | — | — | 0.24 | °C/W |
| R _{th(j-c)R} | | FWDi part (1/6 module) ^{*1} | — | — | 0.36 | °C/W |
| R _{th(c-f)} | Contact thermal resistance | Case to fin, Thermal compound Applied (1/6 module) ^{*2} | — | 0.085 | — | °C/W |
| RG | External gate resistance | | 4.2 | — | 63 | Ω |

BRAKE PART

| Symbol | Parameter | Test conditions | Limits | | | Unit |
|-----------------------|--------------------------------------|---|--------|------|------|------|
| | | | Min. | Typ. | Max. | |
| ICES | Collector cutoff current | VCE = VCES, VGE = 0V | — | — | 1 | mA |
| VGE(th) | Gate-emitter threshold voltage | IC = 5.0mA | 6 | 7 | 8 | V |
| IGES | Gate leakage current | VGE = VGES, VCE = 0V | — | — | 0.5 | μA |
| VCE(sat) | Collector-emitter saturation voltage | IC = 50A, VGE = 15V | — | 2.1 | 3.0 | V |
| | | T _J = 25°C T _J = 125°C | — | 2.4 | — | |
| Cies | Input capacitance | VCE = 10V VGE = 0V | — | — | 8.5 | nF |
| Coēs | Output capacitance | | — | — | 0.75 | nF |
| Cres | Reverse transfer capacitance | | — | — | 0.17 | nF |
| QG | Total gate charge | VCC = 600V, IC = 50A, VGE = 15V | — | 250 | — | nC |
| VFM | Forward voltage drop | IF = 50A | — | — | 3.8 | V |
| R _{th(j-c)Q} | Thermal resistance | IGBT part ^{*1} | — | — | 0.32 | °C/W |
| R _{th(j-c)R} | | Clamp diode part ^{*1} | — | — | 0.43 | °C/W |
| RG | External gate resistance | | 6.3 | — | 63 | Ω |

*1 : T_c measured point is just under the chips.

If you use this value, R_{th(f-a)} should be measured just under the chips.

*2 : Typical value is measured by using Shin-etsu Silicone "G-746".

Note 1. IE, VEC, t_{rr} & Q_{rr} represent characteristics of the anti-parallel, emitter to collector free-wheel diode (FWDi).

2. Pulse width and repetition rate should be such that the device junction temp. (T_J) does not exceed T_{Jmax} rating.

3. Junction temperature (T_J) should not increase beyond 150°C.

4. Pulse width and repetition rate should be such as to cause negligible temperature rise.

CM75RL-24NF

HIGH POWER SWITCHING USE

PERFORMANCE CURVES

OUTPUT CHARACTERISTICS (TYPICAL)

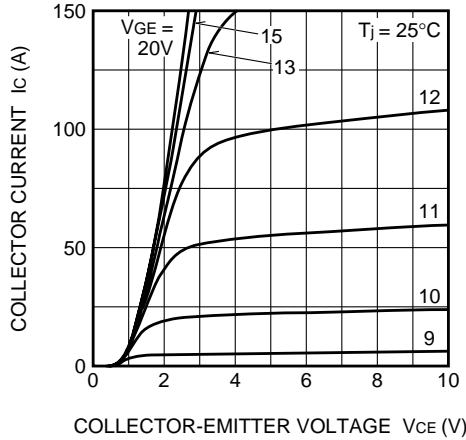

COLLECTOR-EMITTER SATURATION VOLTAGE CHARACTERISTICS (TYPICAL)

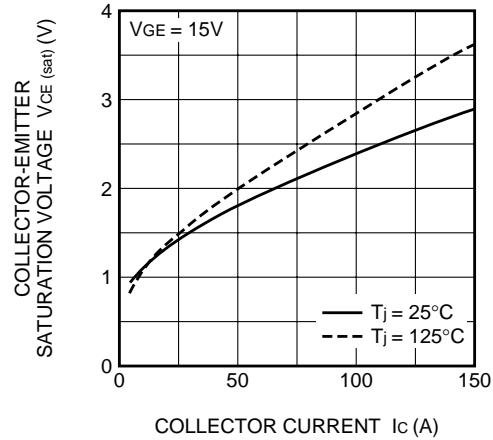

COLLECTOR-EMITTER SATURATION VOLTAGE CHARACTERISTICS (TYPICAL)

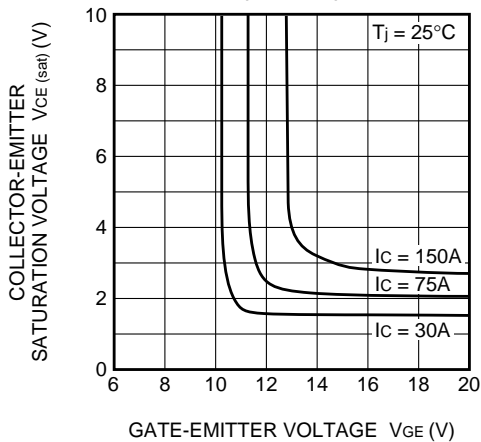

FREE-WHEEL DIODE FORWARD CHARACTERISTICS (TYPICAL)

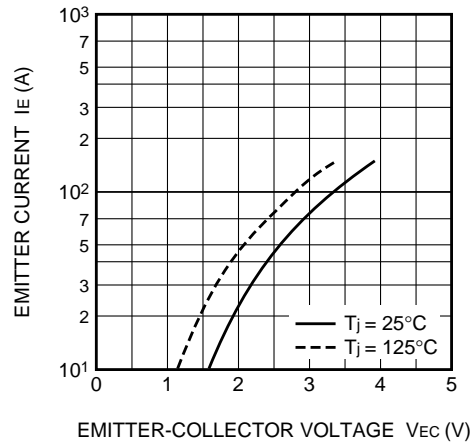

CAPACITANCE-VCE CHARACTERISTICS (TYPICAL)

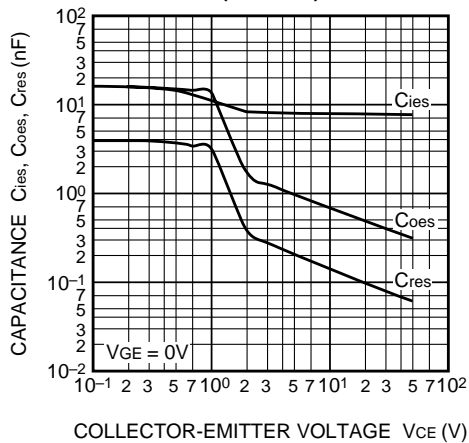

HALF-BRIDGE SWITCHING CHARACTERISTICS (TYPICAL)

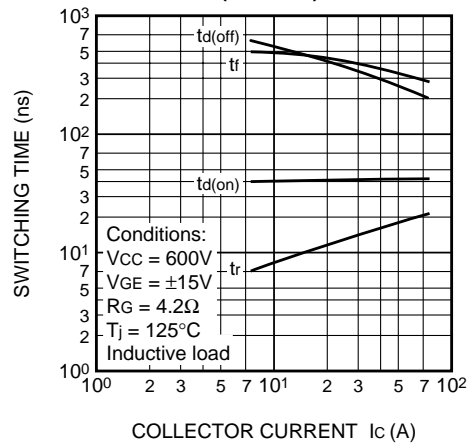

REVERSE RECOVERY CHARACTERISTICS OF FREE-WHEEL DIODE (TYPICAL)

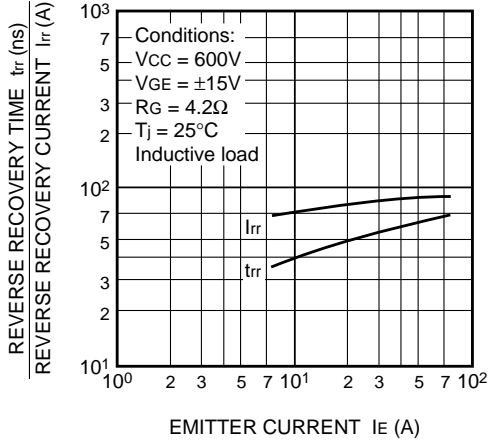

TRANSIENT THERMAL IMPEDANCE CHARACTERISTICS (IGBT part & FWDi part)

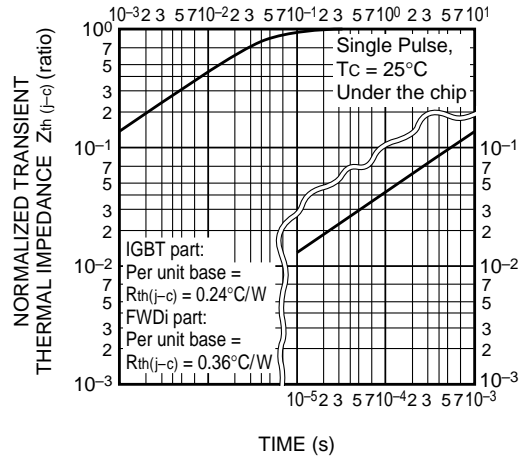

SWITCHING LOSS vs. COLLECTOR CURRENT (TYPICAL)

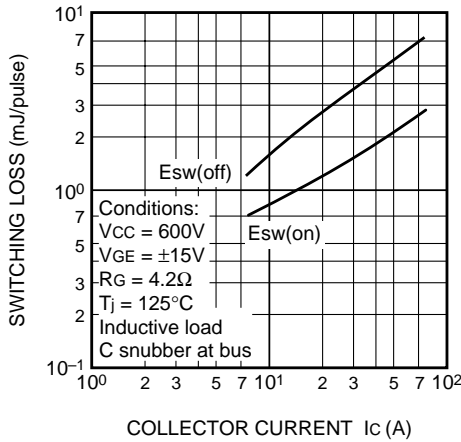

SWITCHING LOSS vs. GATE RESISTANCE (TYPICAL)

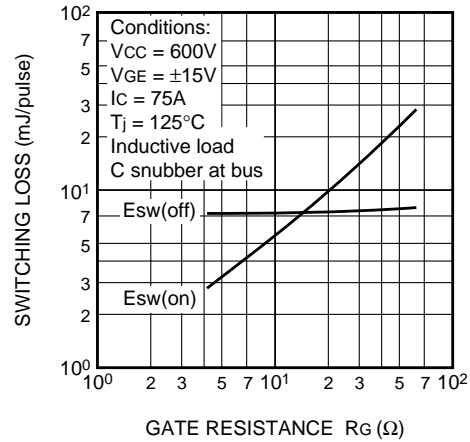

RECOVERY LOSS vs. IE (TYPICAL)

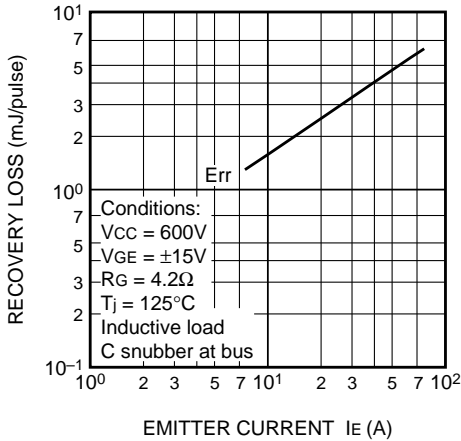

RECOVERY LOSS vs. GATE RESISTANCE (TYPICAL)

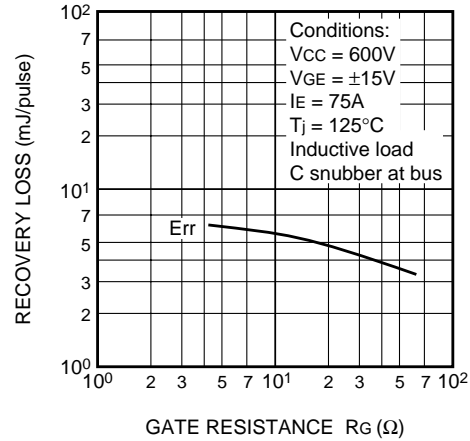

CM75RL-24NF

HIGH POWER SWITCHING USE

