

Ultra-Fast Soft Recovery Diode Module

Description

Ultra-FRD module devices are optimized to reduce losses and EMI/RFI in high frequency power conditioning electrical systems. These diode modules are ideally suited for power converters, motors drives and other applications where switching losses are significant portion of the total losses.



Features

- ☞ Repetitive Reverse Voltage : $V_{RRM} = 600V$
- ☞ Low Forward Voltage Drop : $V_F(\text{typ.}) = 1.4V$
- ☞ Average Forward Current : $I_F(\text{AV.}) = 250A @ T_c = 100^\circ C$
- ☞ Ultra-Fast Reverse Recovery Time : $t_{rr}(\text{typ.}) = 180 \text{ ns}$
- ☞ Extensive Characterization of Recovery Parameters
- ☞ Reduced EMI and RFI
- ☞ Isolation Type Package

Applications

Motor Drives, Free wheel use, High Power Converters, Welders, Various Switching and Telecommunication Power Supply.

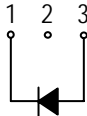
Equivalent Circuit and Package

Equivalent Circuit

Package : 5DM-2 Series

Please see the package Out line information

Absolute Maximum Ratings @ $T_j=25^\circ C$ (Per Leg)

Symbol	Parameter	Conditions	Ratings	Unit
V_{RRM}	Repetitive Peak Reverse Voltage		600	V
$V_{R(DC)}$	Reverse DC Voltage		480	V
$I_{F(AV)}$	Average Forward Current	Resistive Load	@ $T_c = 25^\circ C$ 500	A
			@ $T_c = 100^\circ C$ 250	A
I_{FSM}	Surge(non-repetitive) Forward Current	One Half Cycle at 60Hz, Peak Value	5000	A
I^2_t	I^2t for Fusing	Value for One Cycle Current, $t_w = 8.3\text{ms}, T_j = 25^\circ C$ Start	66.7×10^3	A^2s
T_j	Junction Temperature		-40 ~ 150	$^\circ C$
T_{stg}	Storage Temperature		-40 ~ 125	$^\circ C$
V_{isol}	Isolation Voltage	@ AC 1 minutes	2500	V
P_d	Maximum Power Dissipation		800	W
-	Mounting Torque		4.0	N.m
-	Terminal Torque		3.0	N.m
-	Weight	Typical Including Screws	180	g

Thermal Characteristics

Symbol	Parameter	Conditions	Values			Unit
			Min.	Typ.	Max.	
$R_{th(j-c)}$	Thermal Resistance	Junction to Case	-	-	0.13	°C/W

Electrical Characteristics @ $T_j=25^\circ\text{C}$ (unless otherwise specified)

Symbol	Parameter	Conditions	Values			Unit	
			Min.	Typ.	Max.		
V_R	Cathode Anode Breakdown Voltage	$I_R = 100\mu\text{A}$	600	-	-	V	
V_{FM}	Maximum Forward Voltage	$I_{FM} = 250\text{A}, T_c = 25^\circ\text{C}$	-	1.4	1.7	V	
		$I_{FM} = 250\text{A}, T_c = 100^\circ\text{C}$	-	1.2	1.5	V	
I_{RRM}	Repetitive Peak Reverse Current	$T_c = 100^\circ\text{C}, V_{RRM}$ applied	-	-	10.0	mA	
t_{rr}	Reverse Recovery Time	$I_{FM} = 250\text{A}, V_R = 300\text{V}, di/dt = -100\text{A}/\mu\text{s}$	$T_c = 25^\circ\text{C}$	-	180	200	ns
			$T_c = 100^\circ\text{C}$	-	240	-	ns

Performance Curves

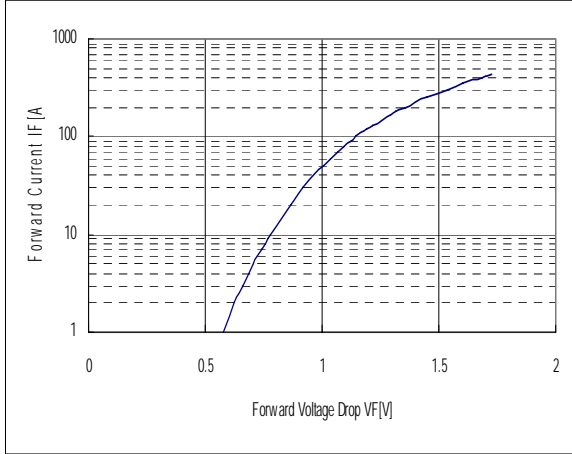

Fig. 1 : Typical Forward Voltage Drop vs. Instantaneous Forward Current

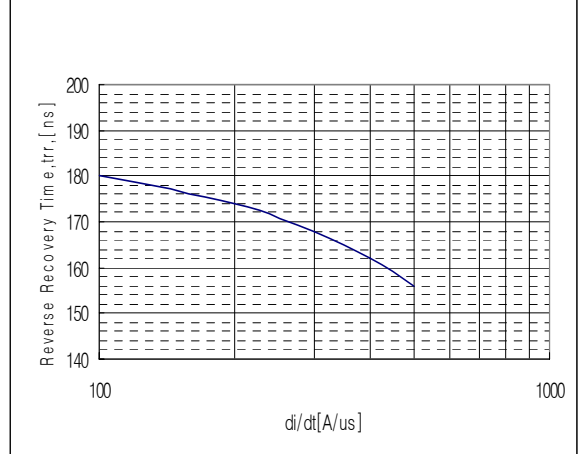

Fig. 2 : Typical Reverse Recovery Time vs. $-di/dt$

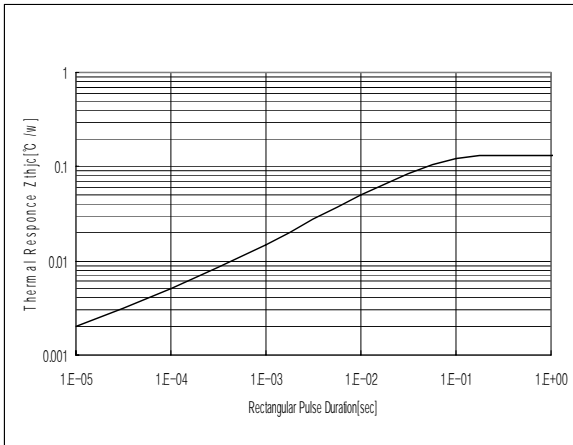

Fig. 3 : Transient Thermal Impedance($Z_{th(jc)}$) Characteristics

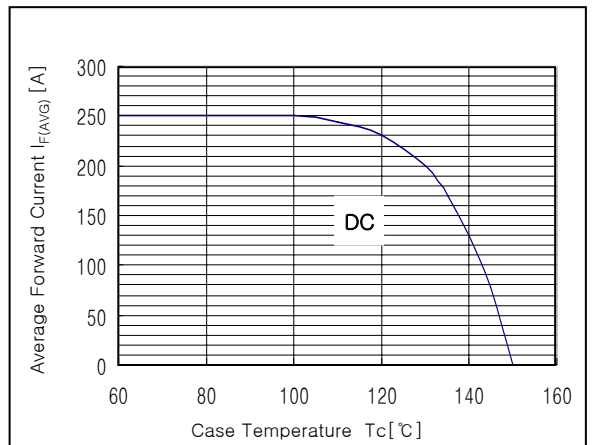
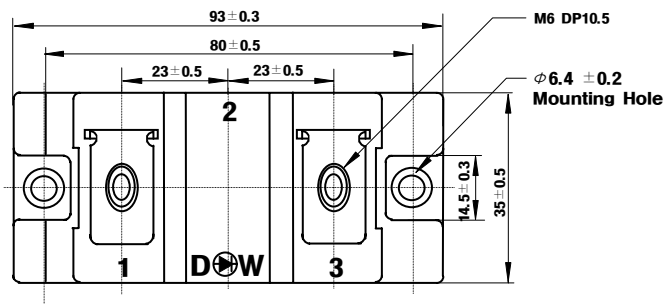

Fig. 4 : Forward Current Derating Curve

Package Out Line Information

5DM-2 Series



Dimensions in mm

