

TOSHIBA INTELLIGENT GTR MODULE SILICON N CHANNEL IGBT

MIG75Q202H

HIGH POWER SWITCHING APPLICATIONS

MOTOR CONTROL APPLICATIONS

- Integrates Inverter, Brake Power Circuits & Control Circuits (IGBT drive units, Protection units for Over-Current, Realtime-Current-Control (RTC), Under-Voltage & Over-Temperature) in One Package.
- The Electrodes are Isolated from Case.
- High Speed Type IGBT : $V_{CE(sat)}=3.5V$ (MAX.)
 $t_{off}=2.8\mu s$ (MAX.)
 $t_{rr}=0.21\mu s$ (MAX.)
- Outline TOSHIBA 2-110A1A
- Weight 520g

EQUIVALENT CIRCUIT

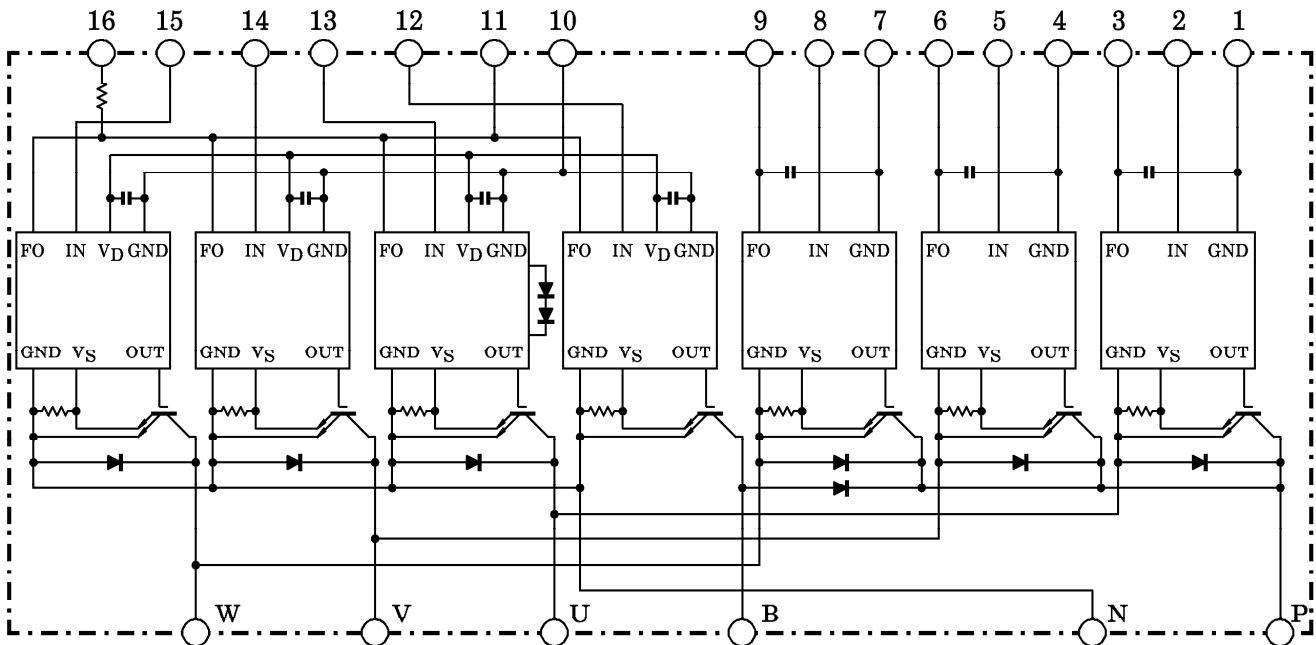

- | | | | | | |
|------------|------------|-----------------------|-------------|------------------------|-----------------------|
| 1. GND (U) | 2. IN (U) | 3. V _D (U) | 4. GND (V) | 5. IN (V) | 6. V _D (V) |
| 7. GND (W) | 8. IN (W) | 9. V _D (W) | 10. GND (L) | 11. V _D (L) | 12. IN (B) |
| 13. IN (X) | 14. IN (Y) | 15. IN (Z) | 16. FO | | |

961001FAA1

● TOSHIBA is continually working to improve the quality and the reliability of its products. Nevertheless, semiconductor devices in general can malfunction or fail due to their inherent electrical sensitivity and vulnerability to physical stress. It is the responsibility of the buyer, when utilizing TOSHIBA products, to observe standards of safety, and to avoid situations in which a malfunction or failure of a TOSHIBA product could cause loss of human life, bodily injury or damage to property. In developing your designs, please ensure that TOSHIBA products are used within specified operating ranges as set forth in the most recent products specifications. Also, please keep in mind the precautions and conditions set forth in the TOSHIBA Semiconductor Reliability Handbook.

● The information contained herein is presented only as a guide for the applications of our products. No responsibility is assumed by TOSHIBA CORPORATION for any infringements of intellectual property or other rights of the third parties which may result from its use. No license is granted by implication or otherwise under any intellectual property or other rights of TOSHIBA CORPORATION or others.

● The information contained herein is subject to change without notice.

MAXIMUM RATINGS ($T_j = 25^\circ\text{C}$)

STAGE	CHARACTERISTIC	CONDITION	SYMBOL	RATINGS	UNIT
Inverter	Supply Voltage	P-N power terminal	V_{CC}	900	V
	Collector-Emitter Voltage	—	V_{CES}	1200	V
	Collector Current	$T_c = 25^\circ\text{C}$, DC	I_C	75	A
	Forward Current	$T_c = 25^\circ\text{C}$, DC	I_F	75	A
	Collector Power Dissipation	$T_c = 25^\circ\text{C}$	P_C	400	W
	Junction Temperature	—	T_j	150	$^\circ\text{C}$
Brake	Supply Voltage	P-N power terminal	V_{CC}	900	V
	Collector-Emitter Voltage	—	V_{CES}	1200	V
	Collector Current	$T_c = 25^\circ\text{C}$, DC	I_C	25	A
	Reverse Voltage	—	V_R	1200	V
	Forward Current	$T_c = 25^\circ\text{C}$, DC	I_F	25	A
	Collector Power Dissipation	$T_c = 25^\circ\text{C}$	P_C	140	W
	Junction Temperature	—	T_j	150	$^\circ\text{C}$
Control	Control Supply Voltage	V_D -GND terminal	V_D	20	V
	Input Voltage	IN-GND terminal	V_{IN}	20	V
	Fault Output Voltage	FO-GND (L) terminal	V_{FO}	20	V
	Fault Output Current	FO sink current	I_{FO}	10	mA
Module	Operating Temperature	—	T_C	-20~+100	$^\circ\text{C}$
	Storage Temperature Range	—	T_{stg}	-40~+125	$^\circ\text{C}$
	Isolation Voltage	AC 1 minute	V_{ISO}	2500	V
	Screw Torque	M5	—	3	Nm

ELECTRICAL CHARACTERISTICS

a. Inverter stage

CHARACTERISTIC	SYMBOL	TEST CONDITION	MIN.	TYP.	MAX.	UNIT	
Collector Cut-Off Current	I_{CEX}	$V_{CEX} = 1200\text{V}$	$T_j = 25^\circ\text{C}$	—	—	1	mA
			$T_j = 125^\circ\text{C}$	—	—	10	
Collector-Emitter Saturation Voltage	$V_{CE}(\text{sat})$	$V_D = 15\text{V}$, $I_C = 75\text{A}$ $V_{IN} = 15\text{V} \rightarrow 0\text{V}$	$T_j = 25^\circ\text{C}$	—	2.6	3.5	V
			$T_j = 125^\circ\text{C}$	—	2.5	—	
Forward Voltage	V_F	$I_F = 75\text{A}$	—	2.2	3.0	V	
Switching Time	t_{on}	$V_{CC} = 600\text{V}$, $I_C = 75\text{A}$ $V_D = 15\text{V}$, $V_{IN} = 15\text{V} \leftrightarrow 0\text{V}$ Inductive load (Note 1)	—	1.0	1.7	μs	
	$t_c(\text{on})$		—	0.4	0.8		
	t_{rr}		—	0.16	0.21		
	t_{off}		—	1.9	2.6		
	$t_c(\text{off})$		—	0.35	0.6		

b. Brake stage

CHARACTERISTIC	SYMBOL	TEST CONDITION		MIN.	TYP.	MAX.	UNIT
Collector Cut-Off Current	I _{CEX}	V _{CEX} = 1200V	T _j = 25°C	—	—	1	mA
			T _j = 125°C	—	—	10	
Collector-Emitter Saturation Voltage	V _{CE (sat)}	V _D = 15V, I _C = 25A V _{IN} = 15V → 0V	T _j = 25°C	—	2.6	3.5	V
			T _j = 125°C	—	2.5	—	
Reverse Voltage	I _R	V _R = 1200V	T _j = 25°C	—	—	1	mA
			T _j = 125°C	—	—	10	
Forward Voltage	V _F	I _F = 25A		—	1.4	2.2	V
Switching Time	t _{on}	V _{CC} = 600V, I _C = 25A V _D = 15V, V _{IN} = 15V ↔ 0V Inductive load (Note 1)		—	1.3	1.9	μs
	t _{c (on)}			—	0.85	1.6	
	t _{rr}			—	0.42	0.50	
	t _{off}			—	1.9	2.6	
	t _{c (off)}			—	0.3	0.6	

c. Control stage (T_j = 25°C)

CHARACTERISTIC	SYMBOL	TEST CONDITION	MIN.	TYP.	MAX.	UNIT	
Control Circuit Current	High Side	I _{D (H)}	V _D = 15V	—	8	12	mA
	Low Side			I _{D (L)}	—	32	
Input On Signal Voltage	V _{IN (on)}	V _D = 15V, I _C = 75mA	1.4	1.6	1.8	V	
Input Off Signal Voltage	V _{IN (off)}	—	2.2	2.5	2.8		
Fault Output Current	Protection	I _{FO (on)}	V _D = 15V	5.4	6.0	6.6	mA
	Normal			I _{FO (off)}	—	—	
Over Current Protection Trip Level	Inverter	OC	V _D = 15V, T _j = 125°C	105	150	—	A
	Brake			85	100	—	
Short Circuit Protection Trip Level	Inverter	SC	V _D = 15V, T _j = 125°C	150	250	—	A
	Brake			120	150	—	
Over Current Cut-Off Time	t _{off (OC)}	V _D = 15V	—	5	—	μs	
Over Temperature Protection	Trip Level	OT	Case temperature	110	118	125	°C
	Reset Level			OTr	—	98	
Control Supply Under Voltage Protection	Trip Level	UV	—	11.5	12.0	12.5	V
	Reset Level			UVr	12.0	12.5	
Fault Output Pulse Width	t _{FO}	V _D = 15V	1	2	3	ms	

d. Thermal resistance ($T_j = 25^\circ\text{C}$)

CHARACTERISTIC	SYMBOL	TEST CONDITION	MIN.	TYP.	MAX.	UNIT
Junction to Case Thermal Resistance	$R_{th(j-c)}$	Inverter IGBT stage	—	—	0.312	$^\circ\text{C/W}$
		Inverter FRD stage	—	—	1.00	
		Brake IGBT stage	—	—	0.892	
		Brake FRD stage	—	—	2.00	
Case to Fin Thermal Resistance	$R_{th(c-f)}$	Compound is applied	—	0.05	—	$^\circ\text{C/W}$

Note 1 : Switching time test circuit & timing chart

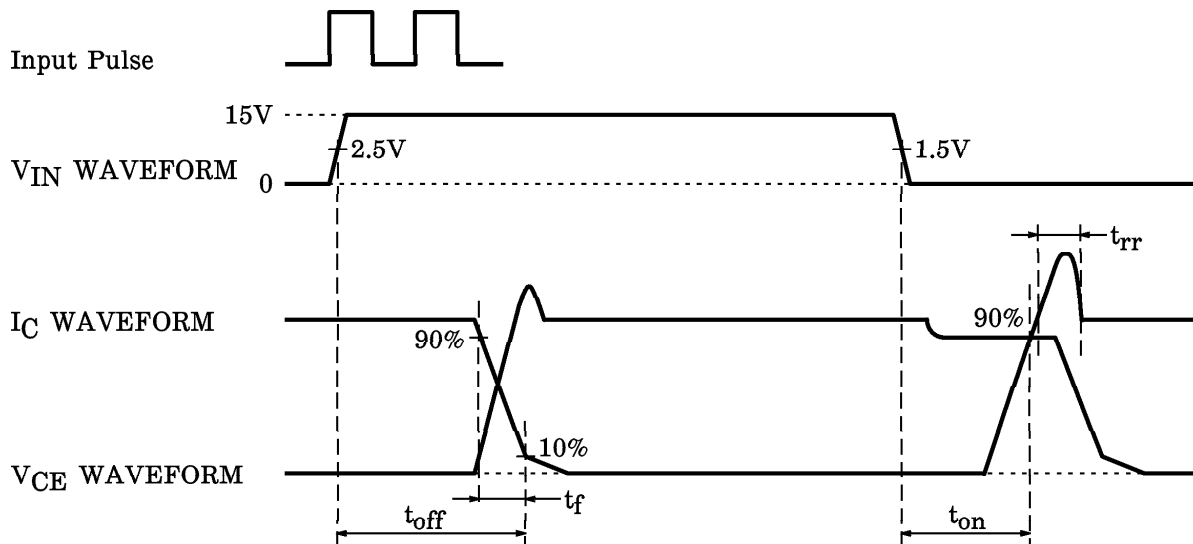
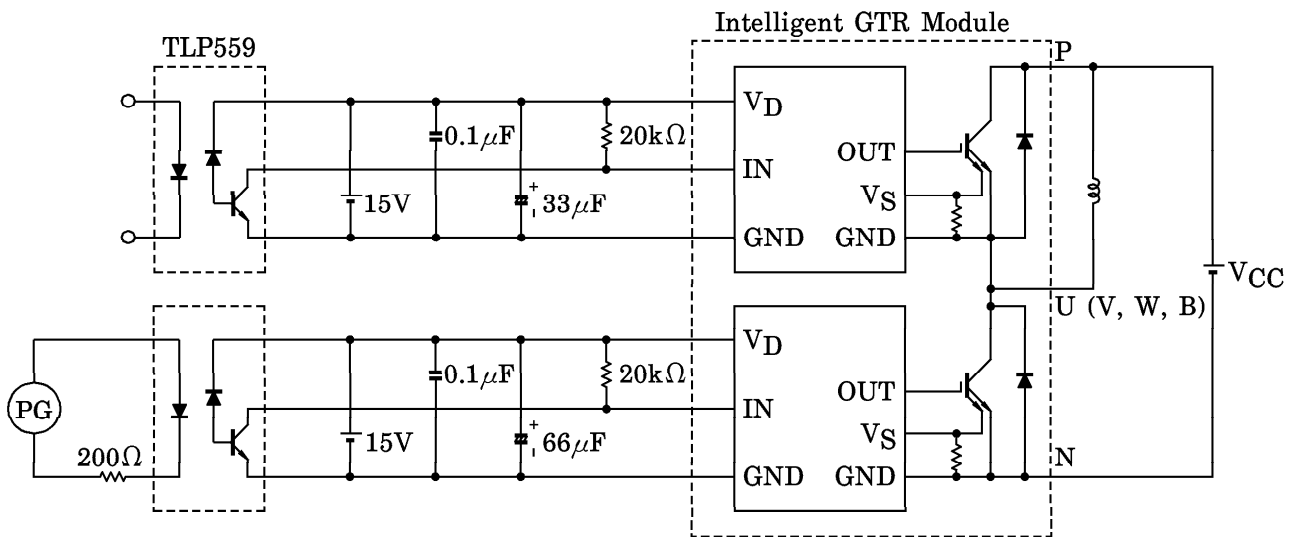

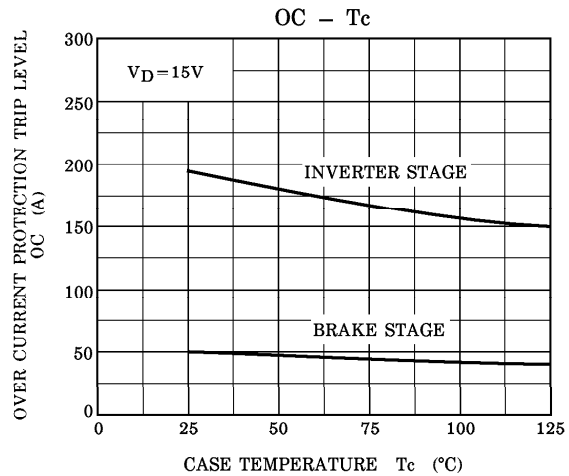
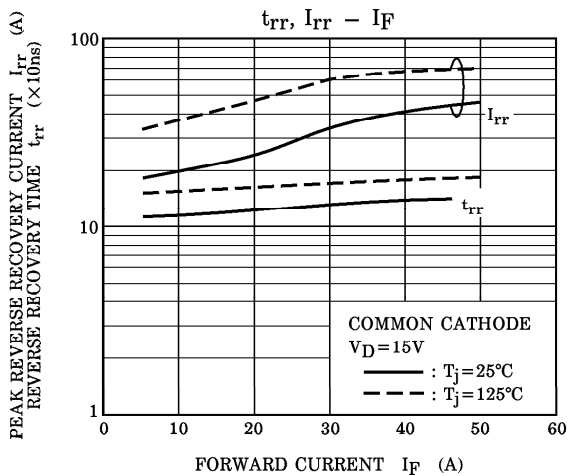
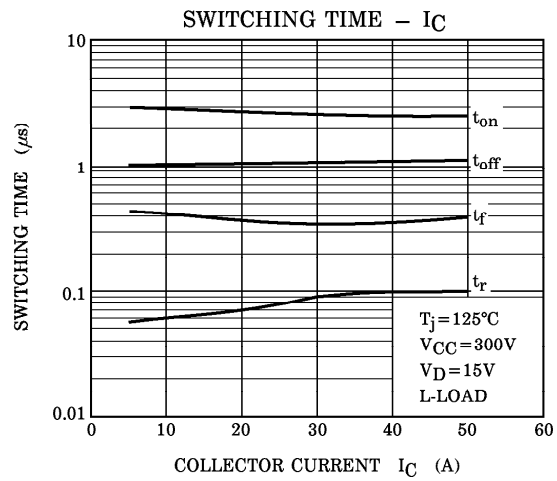
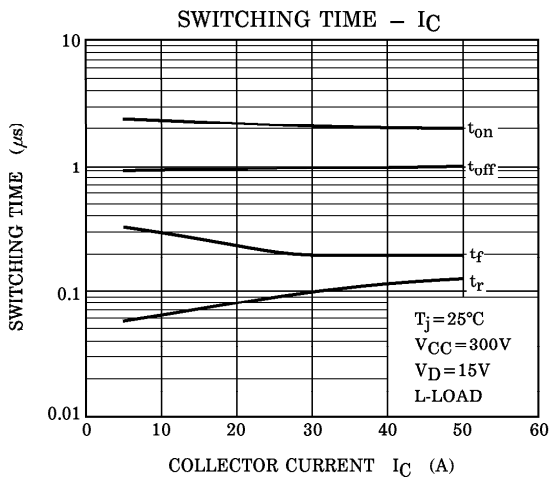
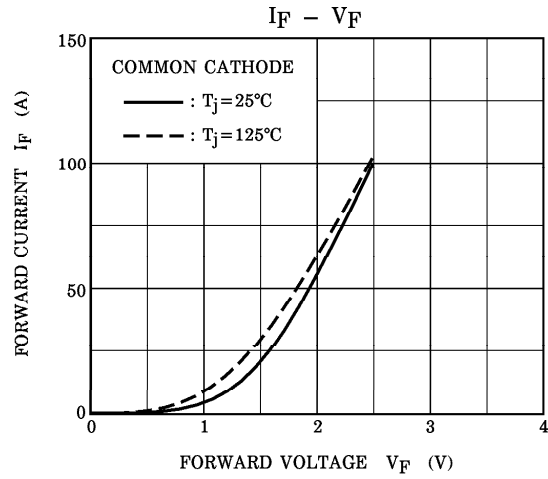
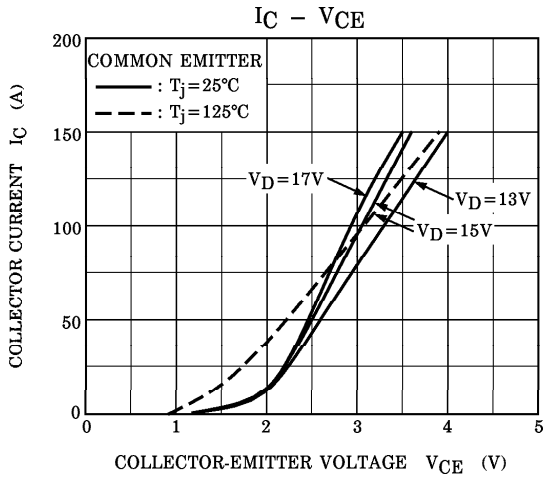

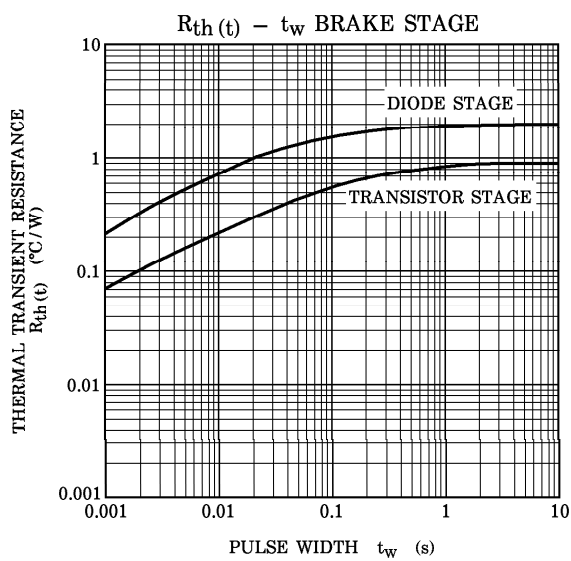
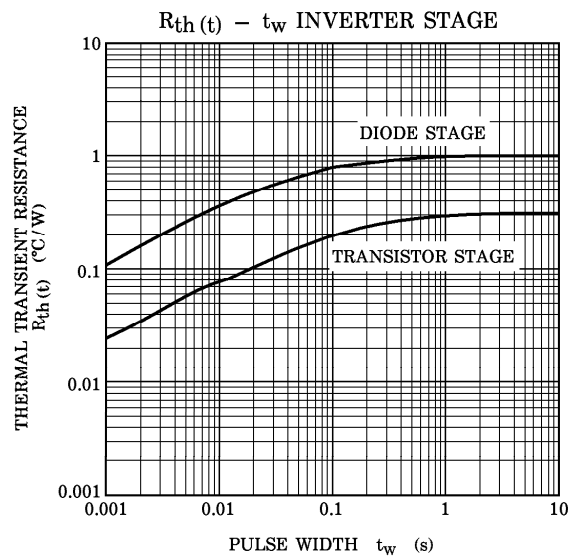
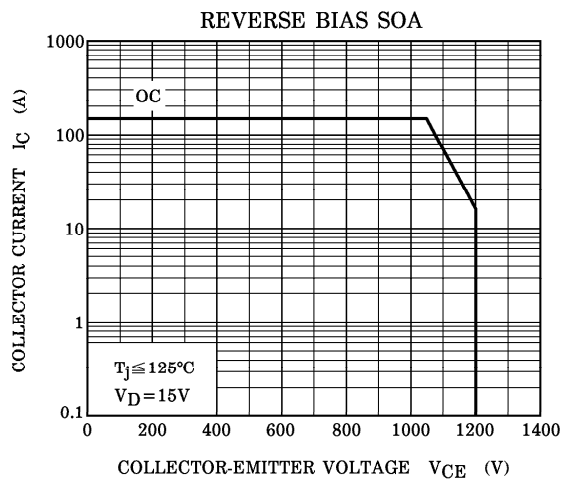
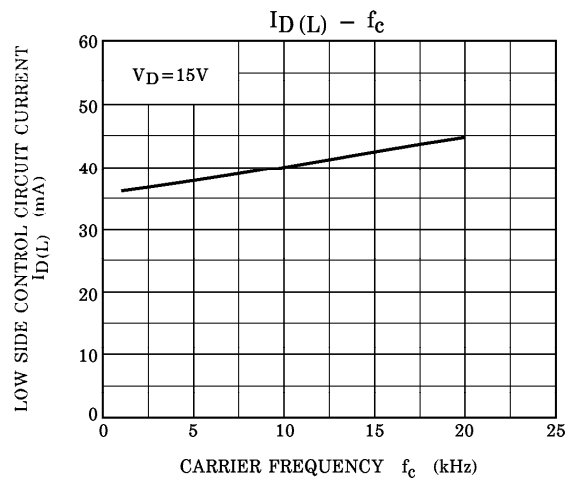
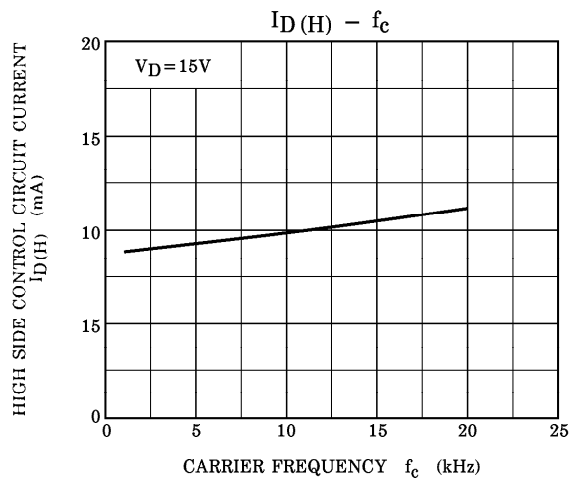

OUTLINE

Unit : mm

