

# SKET 330



**SEMIPACK<sup>®</sup> 4**

## Thyristor Modules

### SKET 330

#### Features

- Heat transfer through aluminium nitride ceramic isolated metal baseplate
- Precious metal pressure contacts for high reliability
- Thyristor with amplifying gate
- UL recognized, file no. E 63 532

#### Typical Applications

- DC motor control (e. g. for machine tools)
- Temperature control (e. g. for ovens, chemical processes)
- Professional light dimming (studios, theaters)

- 1) See the assembly instructions
- 2) The screws must be lubricated

$V_{RSM}$ V	$V_{RRM}, V_{DRM}$ V	$I_{TRMS} = 600$ A (maximum value for continuous operation) $I_{TAV} = 330$ A (sin. 180; $T_c = 78$ °C)	
900	800	SKET 330/08E	
1300	1200	SKET 330/12E	
1500	1400	SKET 330/14E	
1700	1600	SKET 330/16E	
1900	1800	SKET 330/18E	
2100	2000	SKET 330/20E	
2300	2200	SKET 330/22E	

Symbol	Conditions	Values	Units
$I_{TAV}$	sin. 180; $T_c = 85$ (100) °C;	295 (210)	A
$I_D$	P16/300F; $T_a = 35$ °C; B2 / B6	530 / 665	A
$I_{RMS}$	P16/400F; $T_a = 35$ °C; W1 / W3	685 / 3 * 550	A
$I_{TSM}$	$T_{vj} = 25$ °C; 10 ms	9000	A
	$T_{vj} = 130$ °C; 10 ms	8000	A
$i^2t$	$T_{vj} = 25$ °C; 8,3 ... 10 ms	405000	A <sup>2</sup> s
	$T_{vj} = 130$ °C; 8,3 ... 10 ms	320000	A <sup>2</sup> s
$V_T$	$T_{vj} = 25$ °C; $I_T = 1500$ A	max. 2,05	V
$V_{T(TO)}$	$T_{vj} = 130$ °C	max. 1,2	V
$r_T$	$T_{vj} = 130$ °C	max. 0,55	mΩ
$I_{DD}, I_{RD}$	$T_{vj} = 130$ °C; $V_{RD} = V_{RRM}; V_{DD} = V_{DRM}$	max. 120	mA
$t_{gd}$	$T_{vj} = 25$ °C; $I_G = 1$ A; $di_G/dt = 1$ A/μs	1	μs
$t_{gr}$	$V_D = 0,67 * V_{DRM}$	2	μs
$(di/dt)_{cr}$	$T_{vj} = 130$ °C	max. 125	A/μs
$(dv/dt)_{cr}$	$T_{vj} = 130$ °C	max. 1000	V/μs
$t_q$	$T_{vj} = 130$ °C,	150 ... 200	μs
$I_H$	$T_{vj} = 25$ °C; typ. / max.	150 / 500	mA
$I_L$	$T_{vj} = 25$ °C; $R_G = 33$ Ω; typ. / max.	500 / 2000	mA
$V_{GT}$	$T_{vj} = 25$ °C; d.c.	min. 3	V
$I_{GT}$	$T_{vj} = 25$ °C; d.c.	min. 200	mA
$V_{GD}$	$T_{vj} = 130$ °C; d.c.	max. 0,25	V
$I_{GD}$	$T_{vj} = 130$ °C; d.c.	max. 10	mA
$R_{th(j-c)}$	cont.	0,09	K/W
$R_{th(j-c)}$	sin. 180	0,095	K/W
$R_{th(j-c)}$	rec. 120	0,11	K/W
$R_{th(c-s)}$		0,02	K/W
$T_{vj}$		- 40 ... + 130	°C
$T_{stg}$		- 40 ... + 130	°C
$V_{isol}$	a. c. 50 Hz; r.m.s.; 1s / 1 min.	3600 / 3000	V~
$M_s$	to heatsink	$5 \pm 15$ % <sup>1)</sup>	Nm
$M_t$	to terminal	$17 \pm 15$ % <sup>2)</sup>	Nm
$a$		$5 * 9,81$	m/s <sup>2</sup>
$m$	approx.	940	g
Case		A 36	



SKET

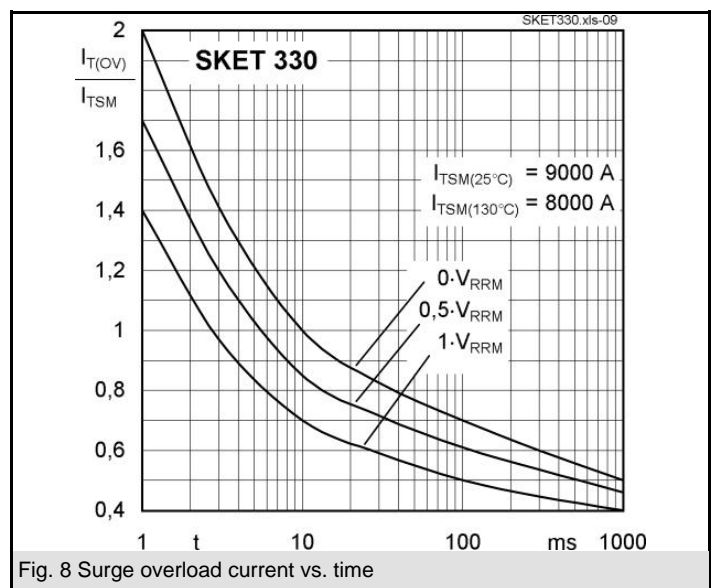
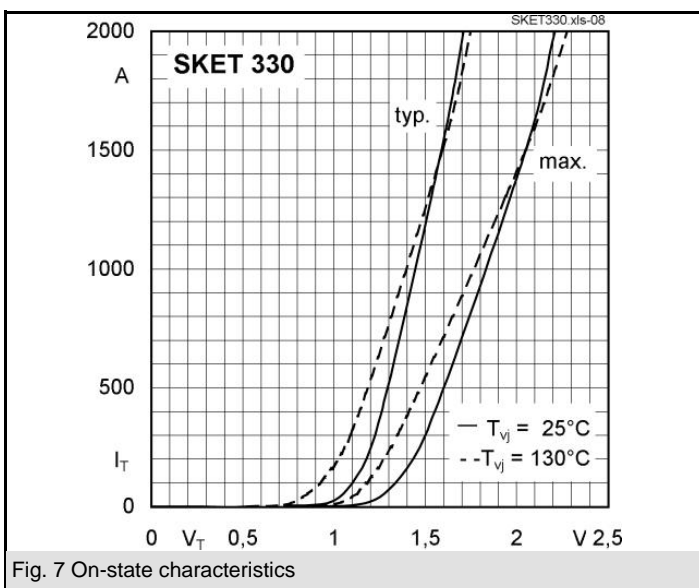
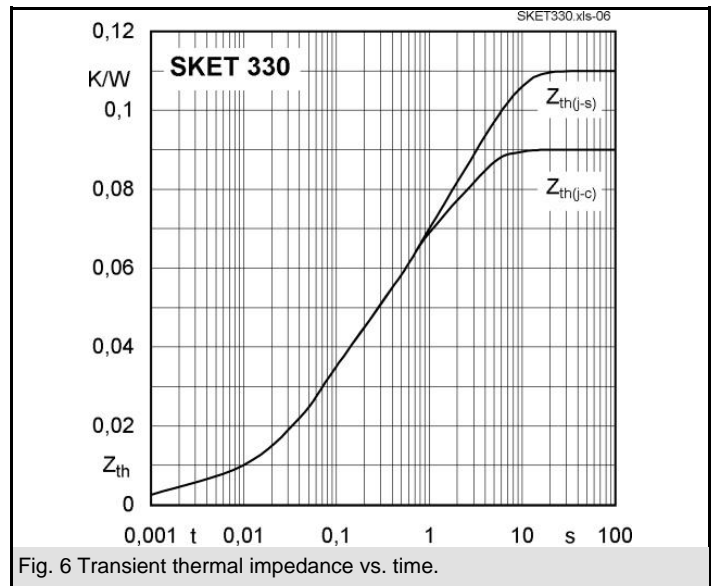
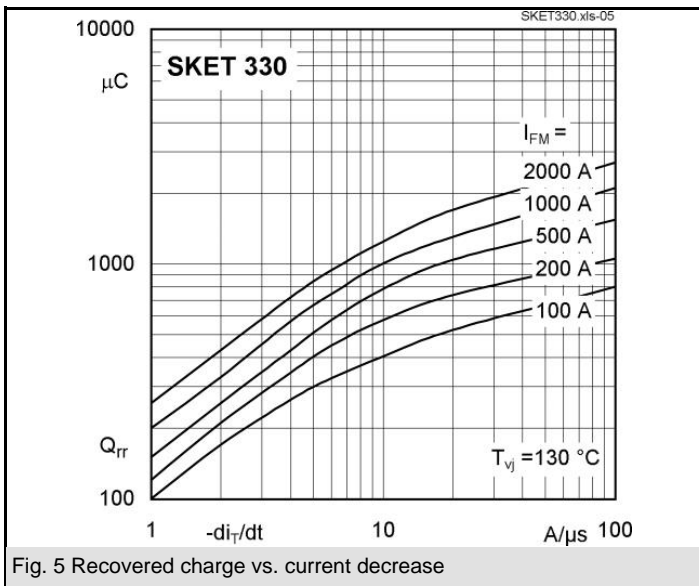
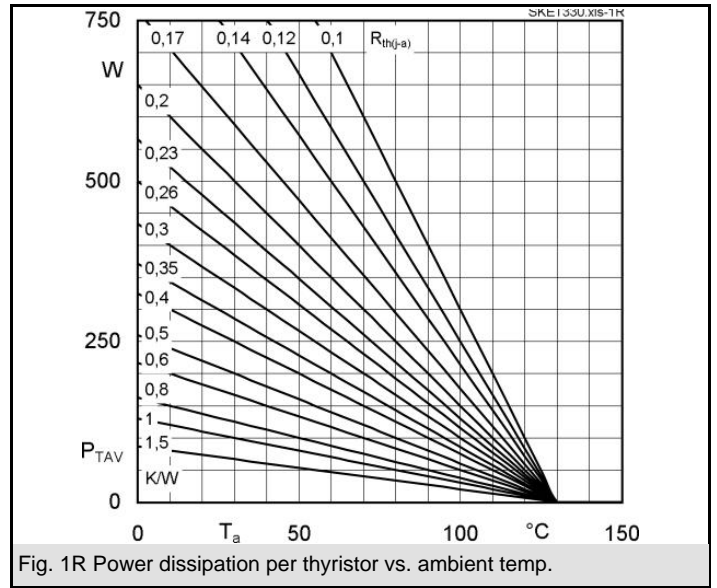
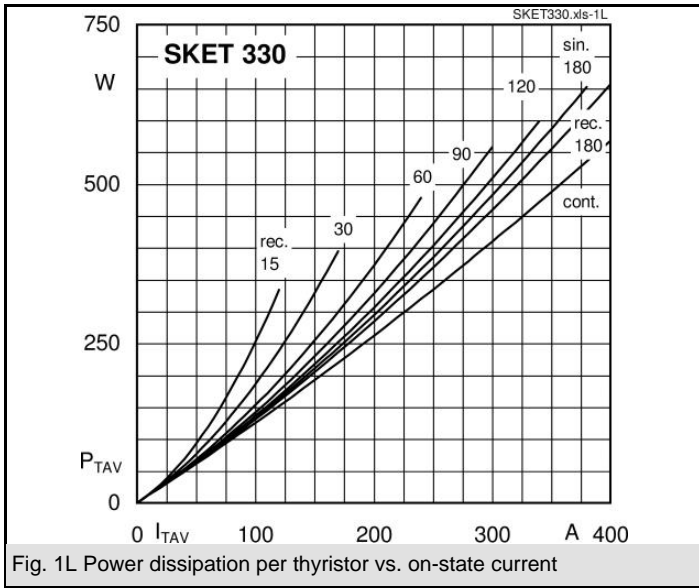

# SKET 330

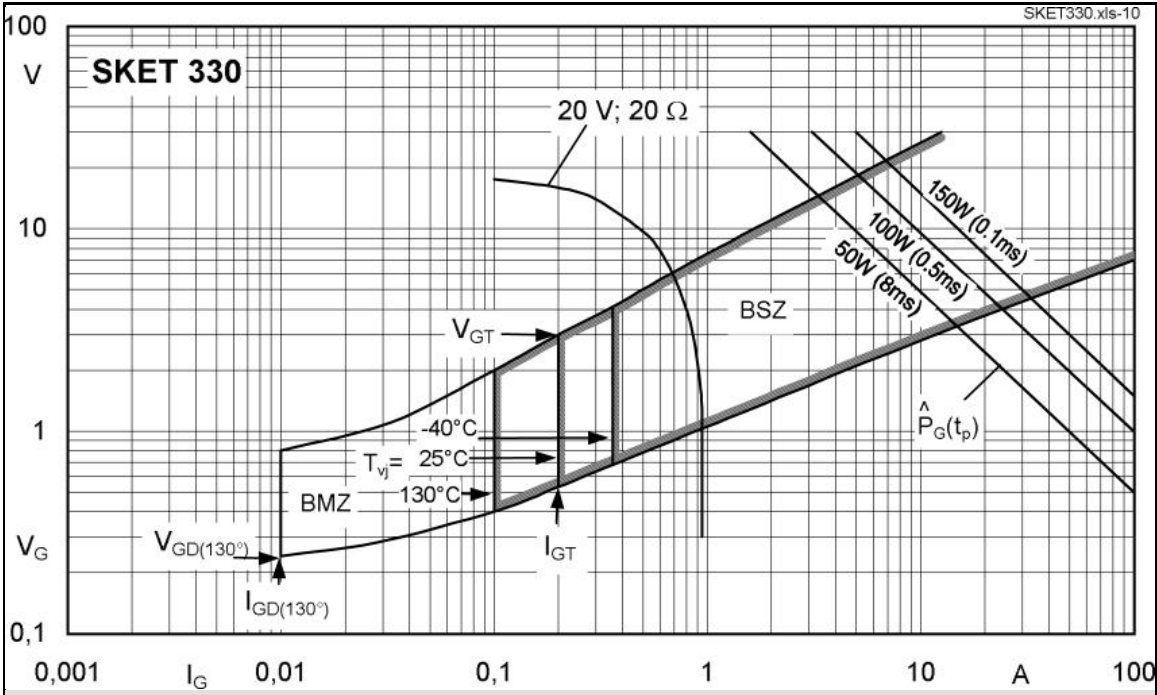
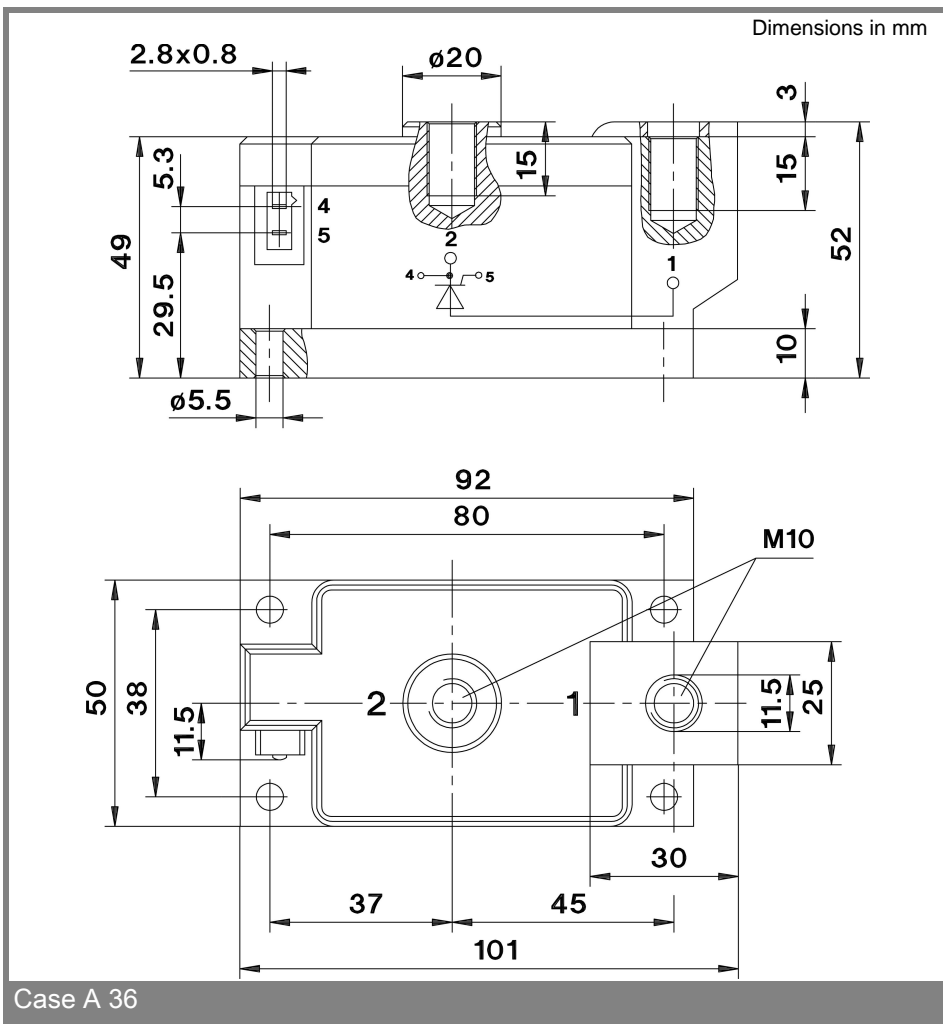

Fig. 9 Gate trigger characteristics



This technical information specifies semiconductor devices but promises no characteristics. No warranty or guarantee expressed or implied is made regarding delivery, performance or suitability.