



Capsule Thyristor

Line Thyristor

SKT 2000

Features

- Hermetic metal case with ceramic insulator
- Capsule package for double sided cooling
- Shallow design with single sided cooling
- Off-state and reverse voltages up to 2800 V
- Amplifying gate

Typical Applications

- DC motor control (e. g. for machine tools)
- Controlled rectifiers (e. g. for battery charging)
- AC controllers (e. g. for temperature control)
- Soft starters for AC motors
- Recommended snubber network e. g. for $V_{VRMS} \leq 400$ V:
 $R = 33 \Omega / 32$ W, $C = 1 \mu F$

V_{RSM} V	V_{RRM}, V_{DRM} V	$I_{TRMS} = 5000$ A (maximum value for continuous operation) $I_{TAV} = 2000$ A (sin. 180; DSC; $T_c = 75$ °C)	
2300	2200	SKT 2000/22E	
2700	2600	SKT 2000/26E	
2900	2800	SKT 2000/28E	

Symbol	Conditions	Values	Units
I_{TAV}	sin. 180; $T_c = 100$ (85) °C;	1250 (1730)	A
I_D	2 x N4/250; $T_a = 45$ °C; B2 / B6	2150 / 3050	A
	2 x N4/400; $T_a = 45$ °C; B2 / B6	2400 / 3400	A
I_{RMS}	2 x N4/250; $T_a = 45$ °C; W1C	2400	A
I_{TSM}	$T_{vj} = 25$ °C; 10 ms	45000	A
	$T_{vj} = 125$ °C; 10 ms	39000	A
i^2t	$T_{vj} = 25$ °C; 8,3 ... 10 ms	10125000	A ² s
	$T_{vj} = 125$ °C; 8,3 ... 10 ms	7600000	A ² s
V_T	$T_{vj} = 25$ °C; $I_T = 3000$ A	max. 1,8	V
$V_{T(TO)}$	$T_{vj} = 125$ °C	max. 1,09	V
r_T	$T_{vj} = 125$ °C	max. 0,236	mΩ
I_{DD}, I_{RD}	$T_{vj} = 125$ °C; $V_{RD} = V_{RRM}; V_{DD} = V_{DRM}$	max. 100	mA
t_{gd}	$T_{vj} = 25$ °C; $I_G = 1$ A; $di_G/dt = 1$ A/μs	1	μs
t_{gr}	$V_D = 0,67 * V_{DRM}$	2	μs
$(di/dt)_{cr}$	$T_{vj} = 125$ °C	max. 150	A/μs
$(dv/dt)_{cr}$	$T_{vj} = 125$ °C	max. 1000	V/μs
t_q	$T_{vj} = 125$ °C	200 ... 300	μs
I_H	$T_{vj} = 25$ °C; typ. / max.	500 / 1000	mA
I_L	$T_{vj} = 25$ °C; typ. / max.	2000 / 5000	mA
V_{GT}	$T_{vj} = 25$ °C; d.c.	min. 3	V
I_{GT}	$T_{vj} = 25$ °C; d.c.	min. 300	mA
V_{GD}	$T_{vj} = 125$ °C; d.c.	max. 0,25	V
I_{GD}	$T_{vj} = 125$ °C; d.c.	max. 10	mA
$R_{th(j-c)}$	cont.; DSC	0,0105	K/W
$R_{th(j-c)}$	sin. 180; DSC / SSC	0,011 / 0,024	K/W
$R_{th(j-c)}$	rec. 120; DSC / SSC	0,0118 / 0,025	K/W
$R_{th(c-s)}$	DSC / SSC	0,002 / 0,004	K/W
T_{vj}		- 40 ... + 125	°C
T_{stg}		- 40 ... + 130	°C
V_{isol}		-	V~
F	mounting force	37 ... 47	kN
a			m/s ²
m	approx.	1000	g
Case		B 20	

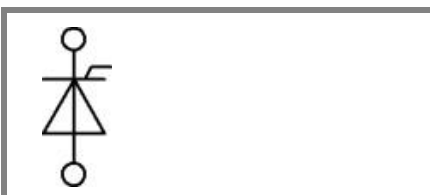

SKT

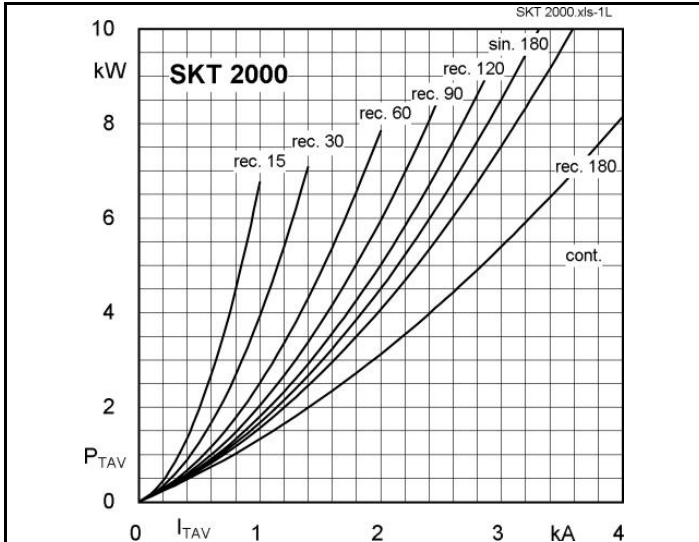

Fig. 1L Power dissipation vs. on-state current

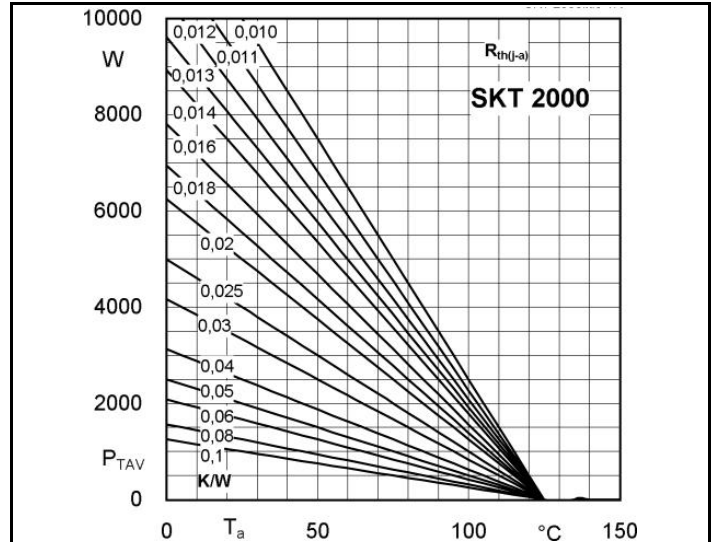

Fig. 1R Power dissipation vs. ambient temperature

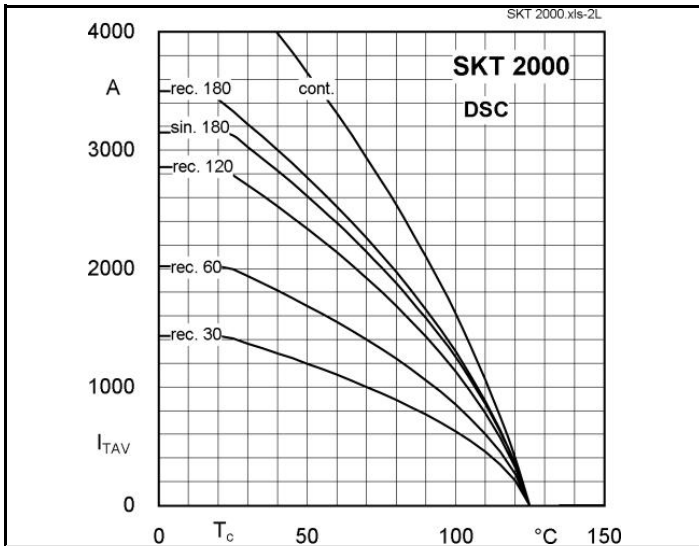

Fig. 2L Rated on-state current vs. case temperature

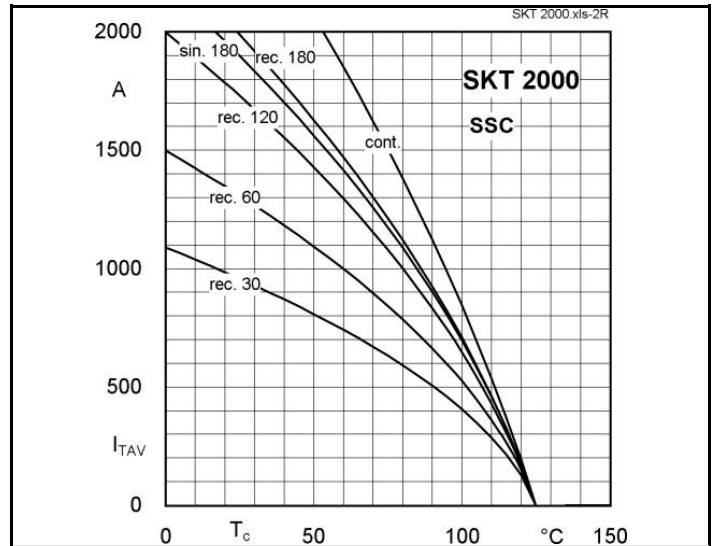

Fig. 2R Rated on-state current vs. case temperature

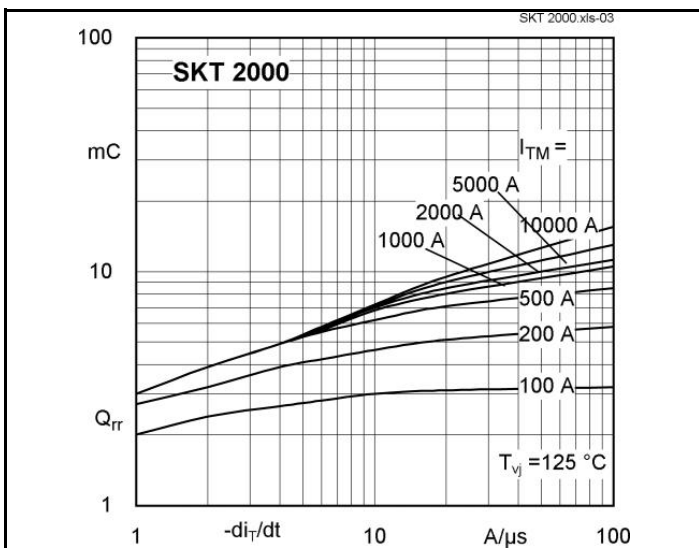

Fig. 3 Recovered charge vs. current decrease

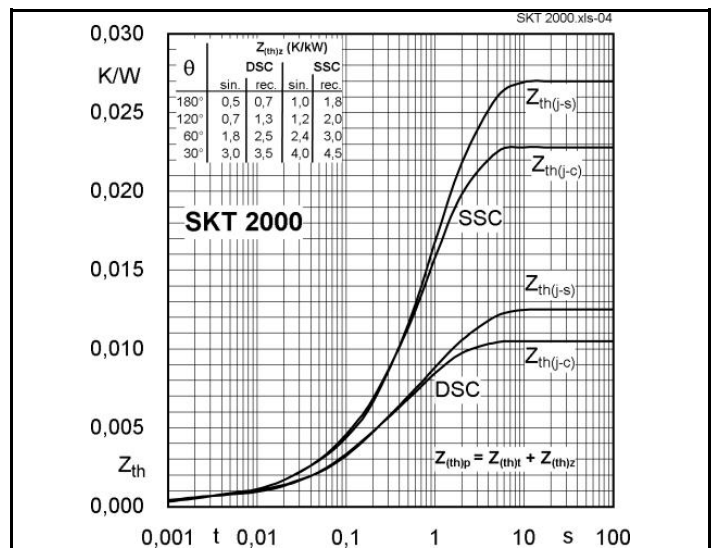
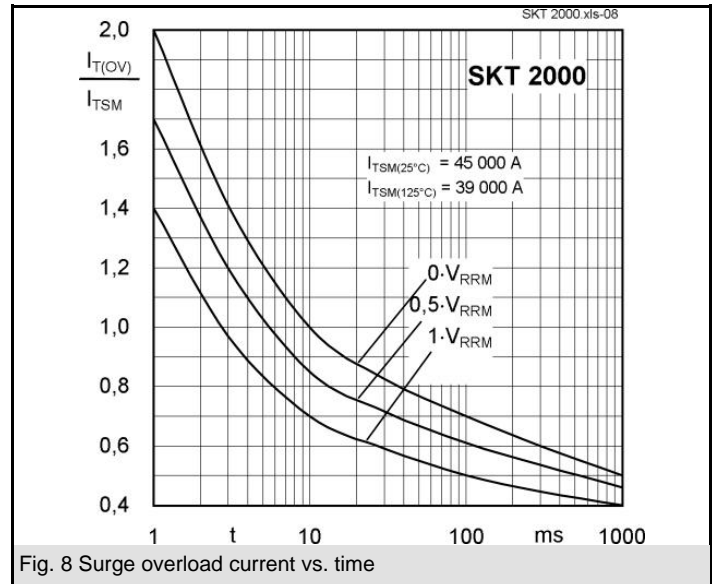
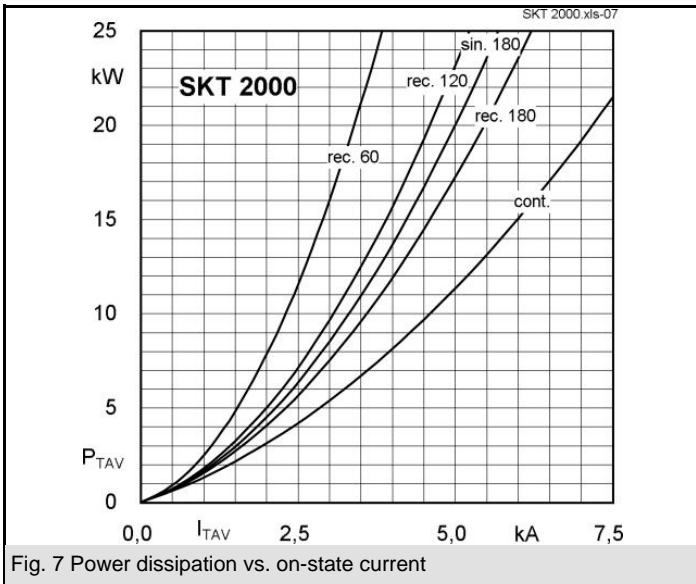
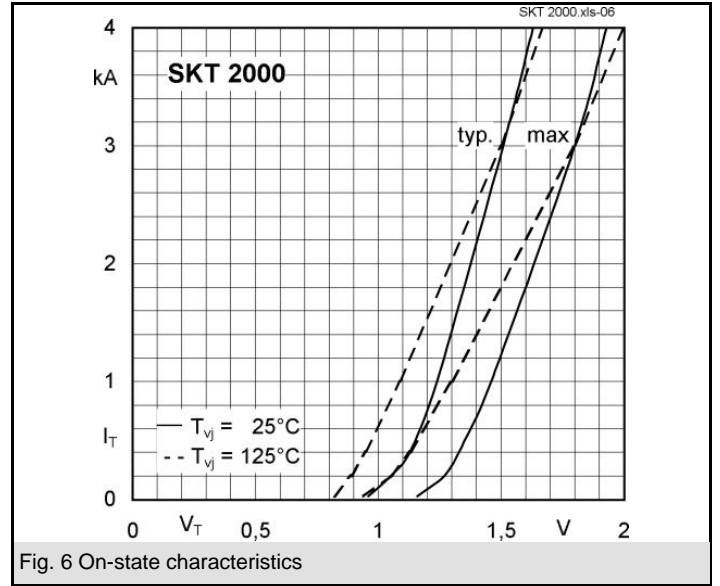
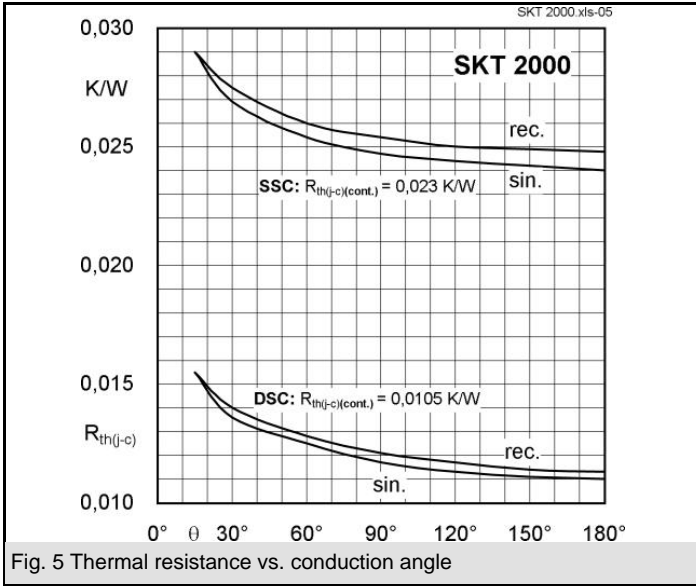
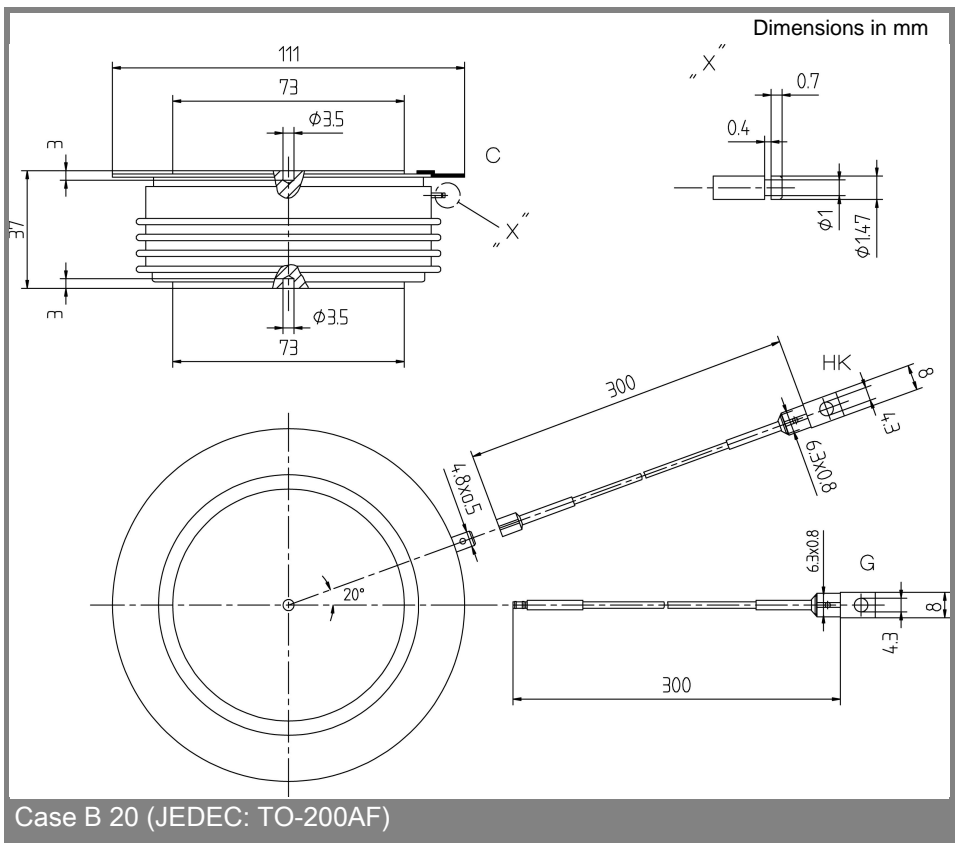
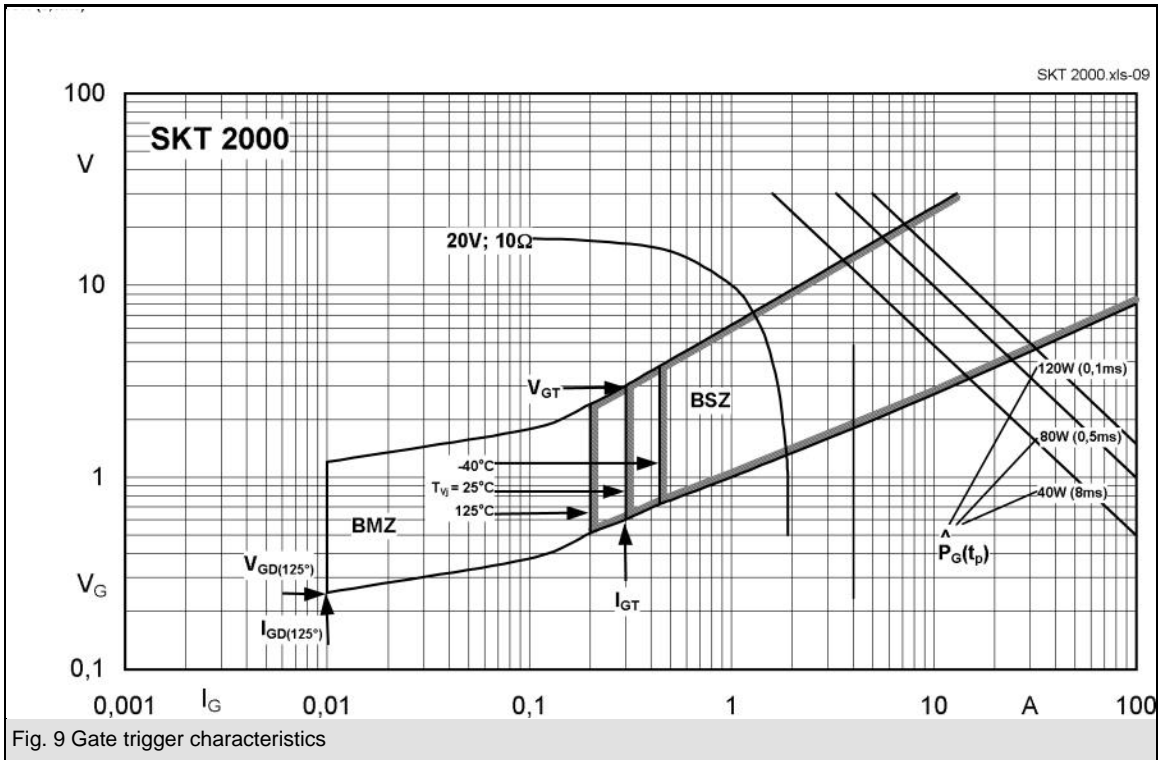

Fig. 4 Transient thermal impedance vs. time





This technical information specifies semiconductor devices but promises no characteristics. No warranty or guarantee expressed or implied is made regarding delivery, performance or suitability.