

Technische Information / Technical Information

eupec

Netz-Thyristor
Phase Control Thyristor

T 3709 N 02...04

N

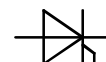

Elektrische Eigenschaften / Electrical properties

Höchstzulässige Werte / Maximum rated values

Periodische Vorwärts- und Rückwärts-Spitzensperrspannung repetitive peak forward off-state and reverse voltages	$T_{vj} = -40^{\circ}\text{C} \dots T_{vj\text{ max}}$	$V_{\text{DRM}}, V_{\text{RRM}}$	200	400 600	V V 1)
Vorwärts-Stoßspitzensperrspannung non-repetitive peak forward off-state voltage	$T_{vj} = -40^{\circ}\text{C} \dots T_{vj\text{ max}}$	V_{DSM}	200	400 600	V V 1)
Rückwärts-Stoßspitzensperrspannung non-repetitive peak reverse voltage	$T_{vj} = +25^{\circ}\text{C} \dots T_{vj\text{ max}}$	V_{RSM}	250	450 650	V V
Durchlaßstrom-Grenzeffektivwert RMSM on-state current		I_{TRSM}		7000	A
Dauergrenzstrom average on-state current	$T_{\text{C}} = 85^{\circ}\text{C}$ $T_{\text{C}} = 69^{\circ}\text{C}$	I_{TAVM}		3710 4456	A A
Stoßstrom-Grenzwert surge current	$T_{vj} = 25^{\circ}\text{C}, t_p = 10\text{ ms}$ $T_{vj} = T_{vj\text{ max}}, t_p = 10\text{ ms}$	I_{TSM}		70 60	kA 2) kA 2)
Grenzlastintegral I^2t -value	$T_{vj} = 25^{\circ}\text{C}, t_p = 10\text{ ms}$ $T_{vj} = T_{vj\text{ max}}, t_p = 10\text{ ms}$	I^2t		24.500 18.000	$\text{A}^2\text{s} \cdot 10^3$ $\text{A}^2\text{s} \cdot 10^3$
Kritische Stromsteilheit critical rate of rise of on-state current	DIN IEC 747-6 $f=50\text{ Hz}, v_L = 10\text{ V}, i_{\text{GM}} = 1\text{ A}$ $di_{\text{G}}/dt = 1\text{ A}/\mu\text{s}$	$(di_{\text{T}}/dt)_{\text{cr}}$		200	$\text{A}/\mu\text{s}$
Kritische Spannungssteilheit critical rate of rise of off-state voltage	$T_{vj} = T_{vj\text{ max}}, v_{\text{D}} = 0,67 V_{\text{DRM}}$ 5.Kennbuchstabe/5th letter F	$(dv_{\text{D}}/dt)_{\text{cr}}$		1000	$\text{V}/\mu\text{s}$

Charakteristische Werte / Characteristic values

Durchlaßspannung on-state voltage	$T_{vj} = T_{vj\text{ max}}, i_{\text{T}} = 15\text{ kA}$ $T_{vj} = T_{vj\text{ max}}, i_{\text{T}} = 4\text{ kA}$	v_{T}	max.	1,50 0,96	V V
Schleusenspannung threshold voltage	$T_{vj} = T_{vj\text{ max}}$	$V_{\text{T(TO)}}$		0,75	V
Ersatzwiderstand slope resistance	$T_{vj} = T_{vj\text{ max}}$	r_{T}		0,0475	$\text{m}\Omega$
Durchlaßkennlinie on-state voltage $v_{\text{T}} = A + B \cdot i_{\text{T}} + C \cdot \ln(i_{\text{T}} + 1) + D \cdot \sqrt{i_{\text{T}}}$	$T_{vj} = T_{vj\text{ max}}$ A = 2,8353E-01 B = 4,5758E-05 C = 6,5261E-02 D = -7,9187E-04				
Zündstrom gate trigger current	$T_{vj} = 25^{\circ}\text{C}, v_{\text{D}} = 6\text{ V}$	I_{GT}	max.	250	mA
Zündspannung gate trigger voltage	$T_{vj} = 25^{\circ}\text{C}, v_{\text{D}} = 6\text{ V}$	V_{GT}	max.	1,5	V
Nicht zündener Steuerstrom gate non-trigger current	$T_{vj} = T_{vj\text{ max}}, v_{\text{D}} = 6\text{ V}$ $T_{vj} = T_{vj\text{ max}}, v_{\text{D}} = 0,5 V_{\text{DRM}}$	I_{GD}	max.	10 5	mA mA
Nicht zündene Steuerspannung gate non-trigger voltage	$T_{vj} = T_{vj\text{ max}}, v_{\text{D}} = 0,5 V_{\text{DRM}}$	V_{GD}	max.	0,2	V
Haltestrom holding current	$T_{vj}=25^{\circ}\text{C}, v_{\text{D}} = 6\text{ V}, R_{\text{A}} = 5\Omega$	I_{H}	max.	300	mA
Einraststrom latching current	$T_{vj}=25^{\circ}\text{C}, v_{\text{D}}=6\text{ V}, R_{\text{GK}} \geq 10\Omega$ $i_{\text{GM}} = 1\text{ A}, di_{\text{G}}/dt = 1\text{ A}/\mu\text{s}$ $t_{\text{g}} = 20\mu\text{s}$	I_{L}	max.	1200	mA
Vorwärts- und Rückwärts-Sperrstrom forward off-state and reverse currents	$T_{vj} = T_{vj\text{ max}}$ $v_{\text{D}} = V_{\text{DRM}}, v_{\text{R}} = V_{\text{RRM}}$	$i_{\text{D}}, i_{\text{R}}$	max.	200	mA
Zündverzug gate controlled delay time	DIN IEC 747-6 $T_{vj} = 25^{\circ}\text{C}$ $i_{\text{GM}} = 1\text{ A}, di_{\text{G}}/dt = 1\text{ A}/\mu\text{s}$	t_{gd}	max.	4	μs

1) 600 v auf Anfrage / 600 V on demand

2) Gehäusegrenzstrom 36 kA (50Hz Sinushalbwellen). / Current limit of case 36 kA (50Hz sinusoidal half-wave).

prepared by: K. A. Rüter

data of publication:

BIP AM

approved by: J. Novotny

revision: 1

A29/00

Seite / page: 1

Netz-Thyristor
Phase Control Thyristor

T 3709 N 02...04



Elektrische Eigenschaften / Electrical properties

Charakteristische Werte / Characteristic values

Freiwerdezeit circuit commutated turn-off time	$T_{vj} = T_{vj\ max}, i_{TM} = I_{TAVM}$ $V_{RM} = 100V, V_{DM} = 0,67 V_{DRM}$ $dv_p/dt = 20 V/\mu s, -di_T/dt = 10 A/\mu s$ 4. Kennbuchstabe / 4th letter O	t_q	typ. 200	μs
---	---	-------	----------	---------

Thermische Eigenschaften / Thermal properties

Innerer Wärmewiderstand thermal resistance, junction to case	Kühlfläche / cooling surface beidseitig / two-sided, $\varphi = 180^\circ \sin$ beidseitig / two-sided, DC Anode / anode, $\varphi = 180^\circ \sin$ Anode / anode, DC Kathode / cathode, $\varphi = 180^\circ \sin$ Kathode / cathode, DC	R_{thJC}	max. 0,0125 max. 0,0117 max. 0,0232 max. 0,0225 max. 0,0250 max. 0,0245	$^\circ C/W$ $^\circ C/W$ $^\circ C/W$ $^\circ C/W$ $^\circ C/W$ $^\circ C/W$
Übergangs- Wärmewiderstand thermal resistance, case to heatsink	Kühlfläche / cooling surface beidseitig / two-sided einseitig / single-sided	R_{thCK}	max. 0,0030 max. 0,0060	$^\circ C/W$ $^\circ C/W$
Höchstzulässige Sperrschichttemperatur max. junction temperature		$T_{vj\ max}$	140	$^\circ C$
Betriebstemperatur operating temperature		$T_{c\ op}$	-40...140	$^\circ C$
Lagertemperatur storage temperature		T_{stg}	-40...150	$^\circ C$

Mechanische Eigenschaften / Mechanical properties

Gehäuse, siehe Anlage case, see appendix			Seite 3 page 3	
Si-Element mit Druckkontakt Si-pellet with pressure contact				
Anpreßkraft clamping force		F	30...65	kN
Gewicht weight		G	typ. 900	g
Kriechstrecke creepage distance			30	mm
Feuchteklasse humidity classification	DIN 40040		C	
Schwingfestigkeit vibration resistance	f = 50Hz		50	m/s ²

Mit dieser technischen Information werden Halbleiterbauelemente spezifiziert, jedoch keine Eigenschaften zugesichert. Sie gilt in Verbindung mit den zugehörigen Technischen Erläuterungen./ The technical information specifies semiconductor devices but promises no characteristics. It is valid in combination with the belonging technical notes.

Netz-Thyristor
Phase Control Thyristor

T 3709 N 02...04

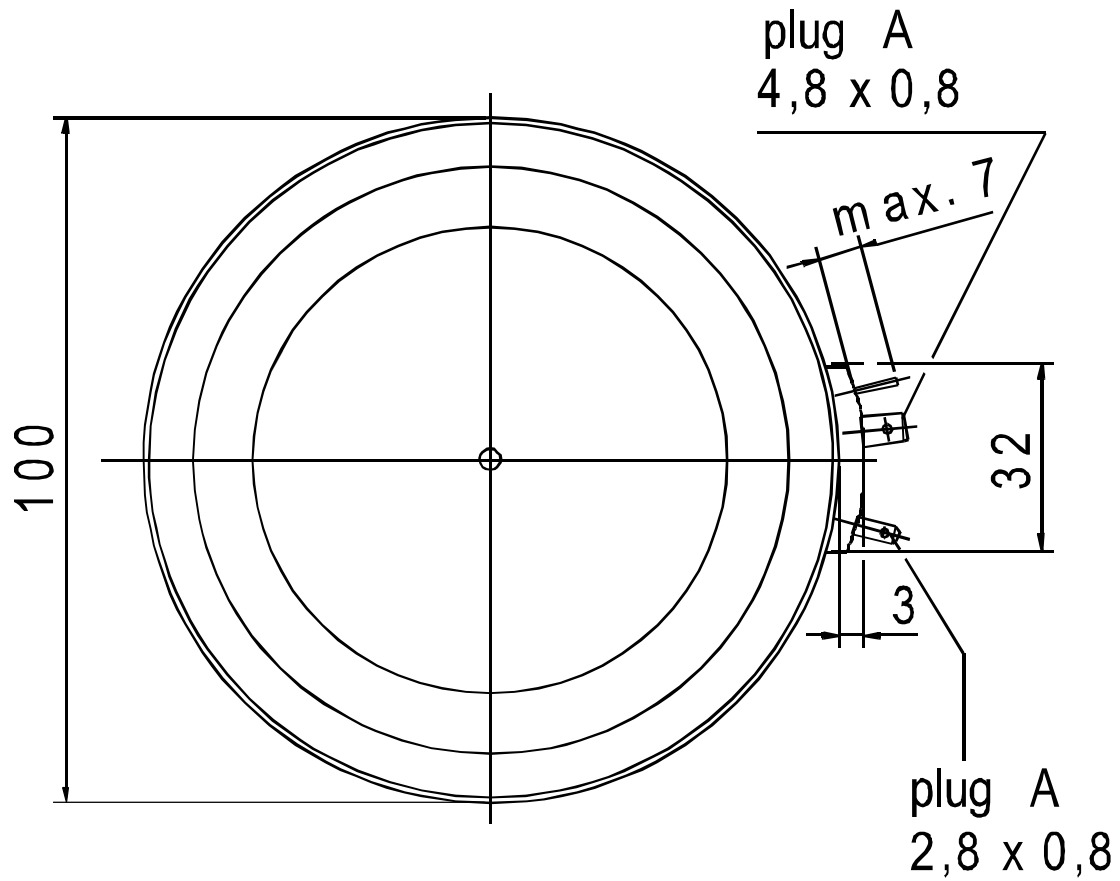
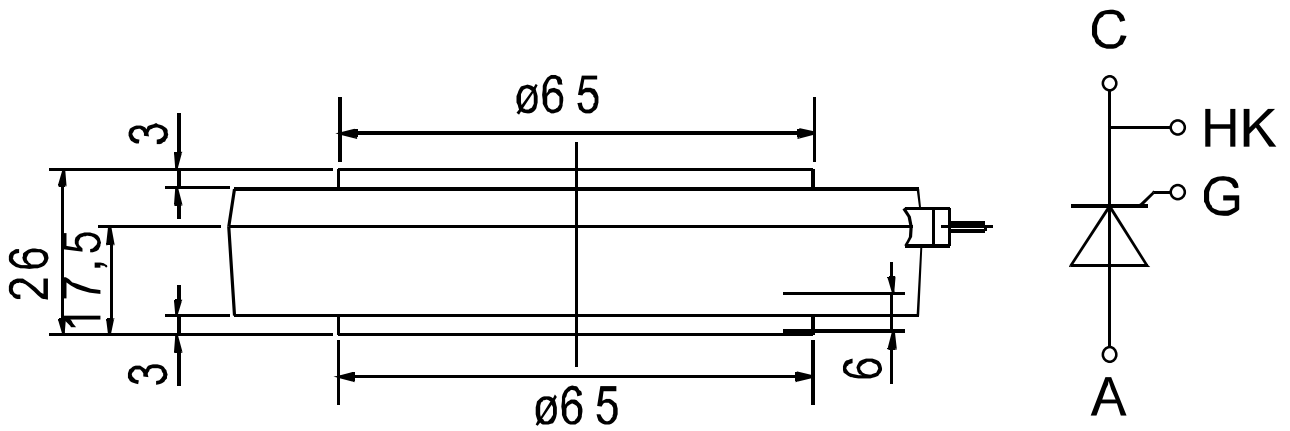

Kühlung cooling	Analytische Elemente des transienten Wärmewiderstandes Z_{thJC} für DC Analytical elements of transient thermal impedance Z_{thJC} for DC							
	Pos.n	1	2	3	4	5	6	7
beidseitig two-sided	R_{thn} [°C/W]	0,000034	0,000570	0,000912	0,002740	0,004250	0,00320	
	τ_n [s]	0,000287	0,002980	0,013500	0,134000	0,449000	2,05000	
anodenseitig anode-sided	R_{thn} [°C/W]	0,000035	0,000600	0,001050	0,007600	0,008500	0,004700	
	τ_n [s]	0,000287	0,002300	0,024000	0,310000	1,900000	6,100000	
kathodenseitig cathode-sided	R_{thn} [°C/W]	0,000035	0,000600	0,002050	0,008050	0,009000	0,004770	
	τ_n [s]	0,000287	0,003000	0,057000	0,380000	2,050000	6,100000	

Analytische Funktion / analytical function : $Z_{thJC} = \sum_{n=1}^{n_{max}} R_{thn} (1 - EXP (- t / \tau_n))$

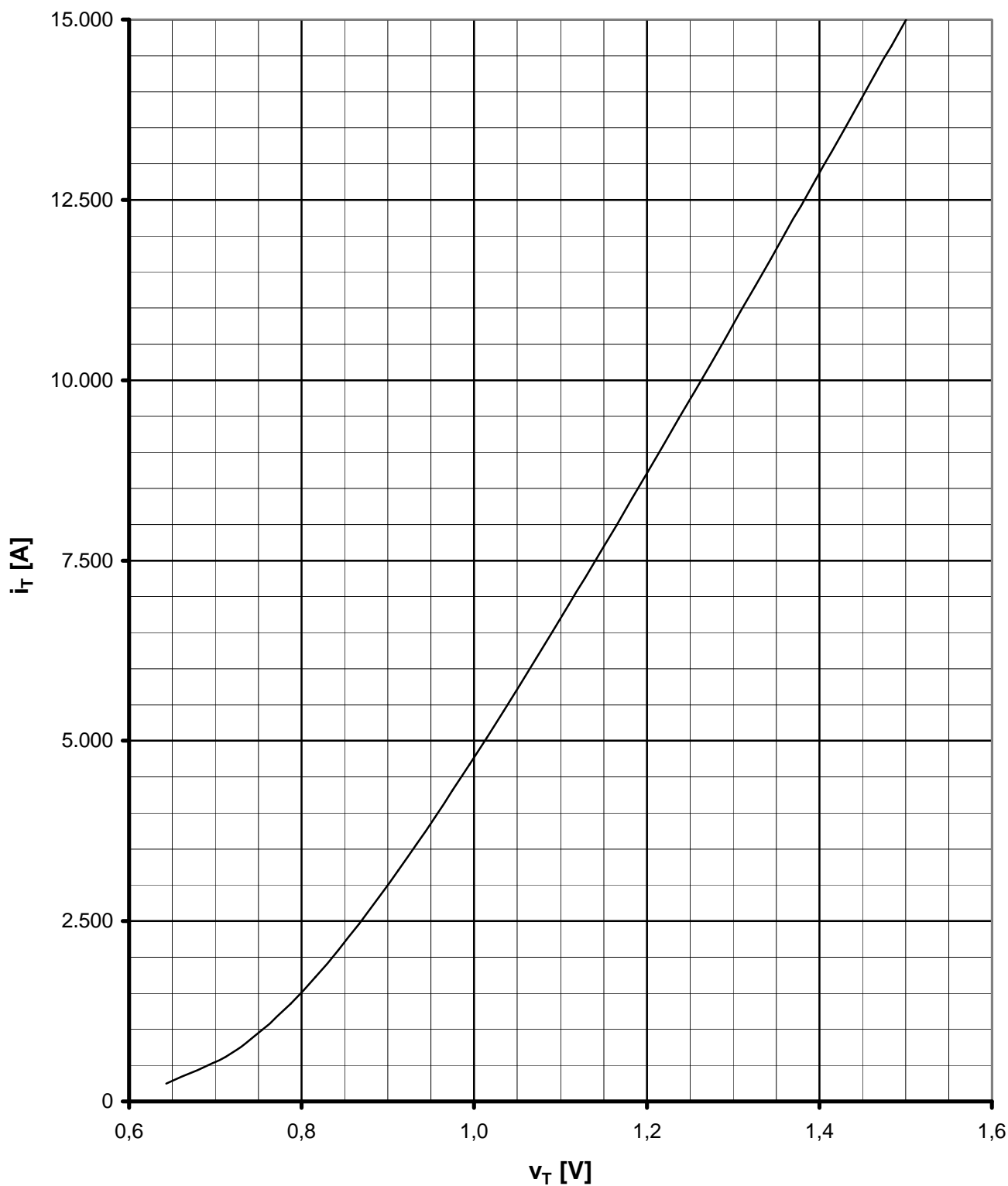

Grenzdurchlaßkennlinie / Limiting On-state characteristic $i_T = f(v_T)$
 $T_{vj} = T_{vj} \text{ max}$

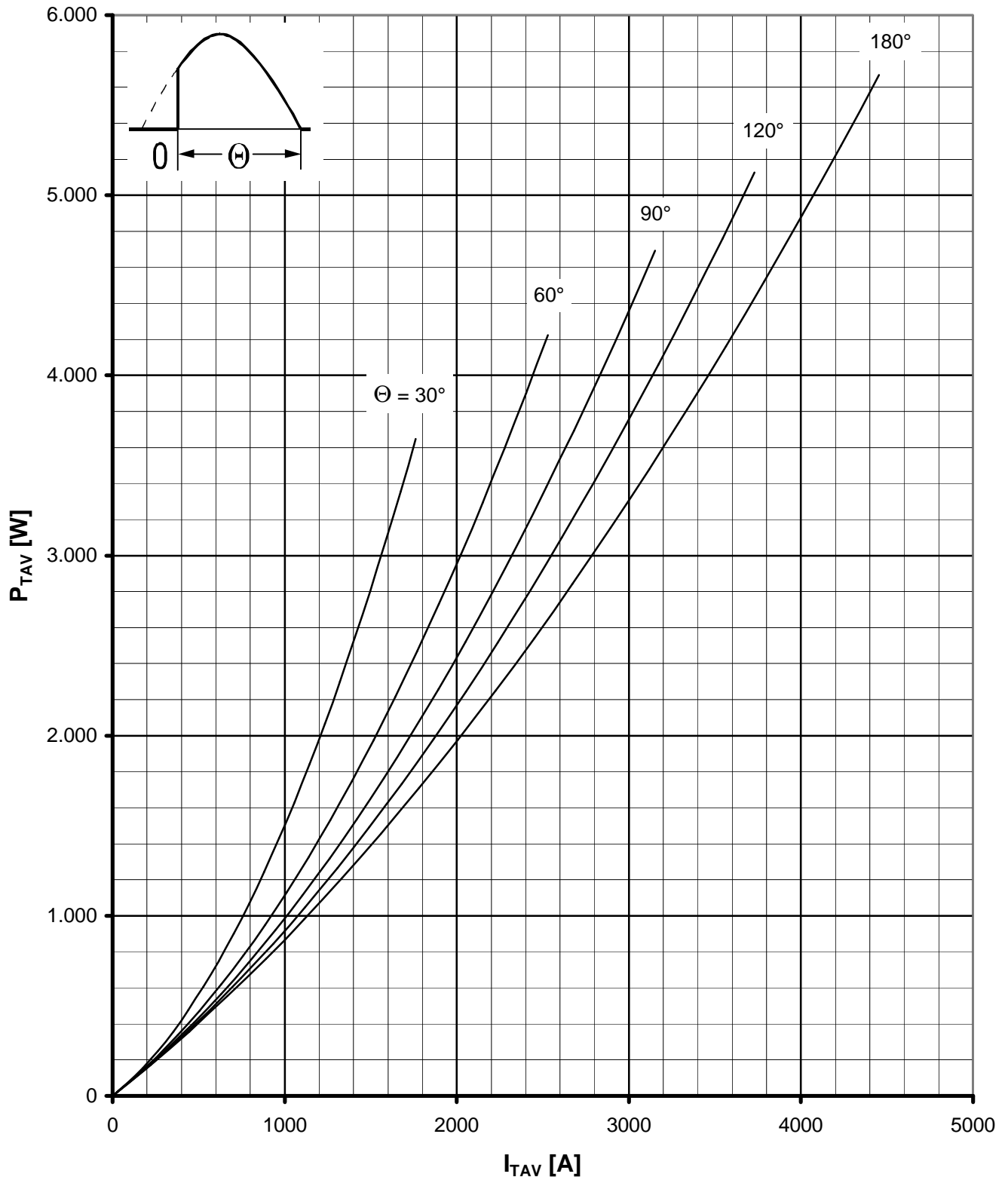

Durchlaßverlustleistung / On-state power loss $P_{TAV} = f(I_{TAV})$
 Parameter: Stromflußwinkel Θ / current conduction angle Θ

Netz-Thyristor
Phase Control Thyristor

T 3709 N 02...04

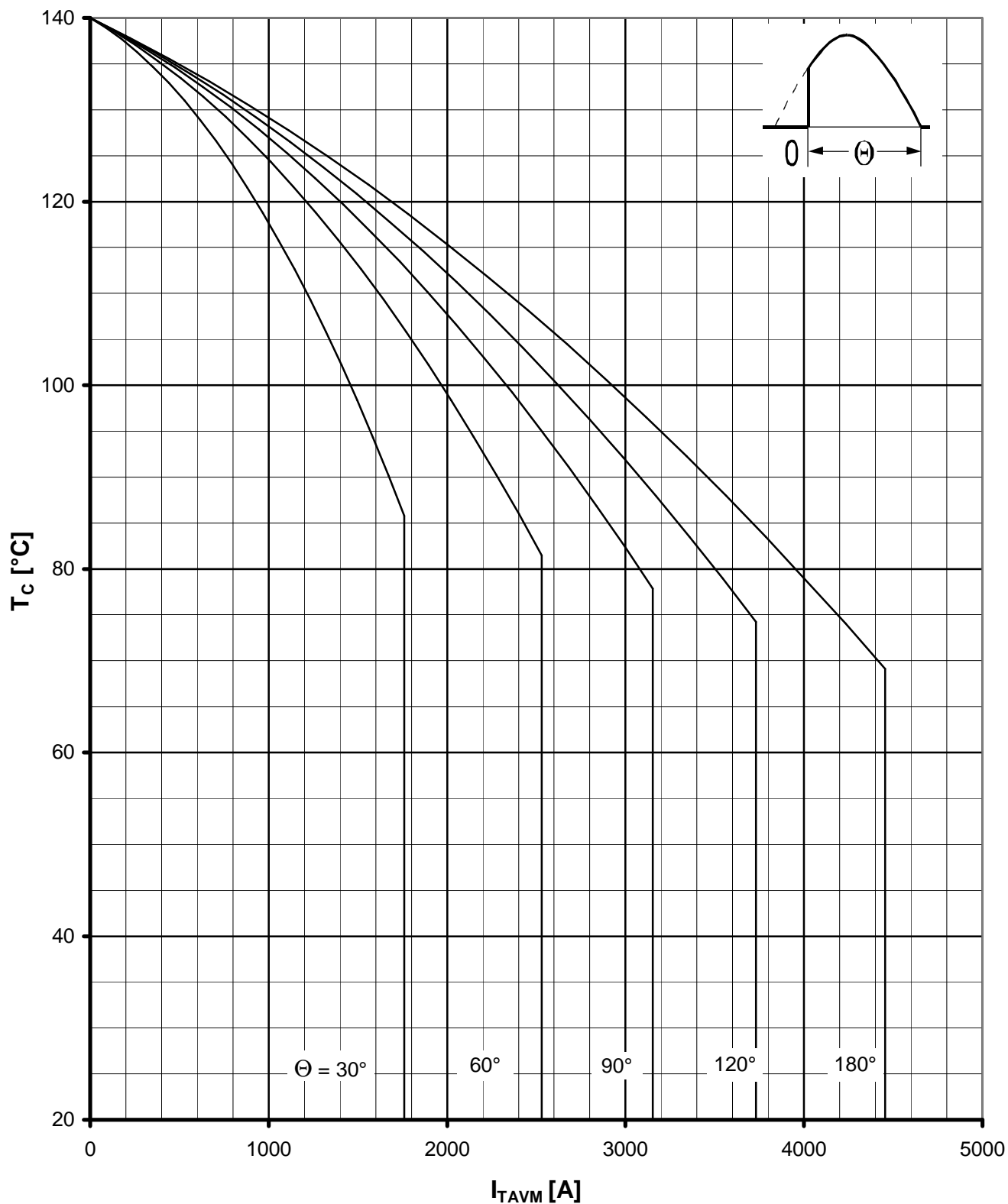

Höchstzulässige Gehäusetemperatur / Maximum allowable case temperature $T_c = f(I_{TAVM})$

Beidseitige Kühlung / Two-sided cooling

Parameter: Stromflußwinkel θ / current conduction angle θ

Netz-Thyristor
Phase Control Thyristor

T 3709 N 02...04

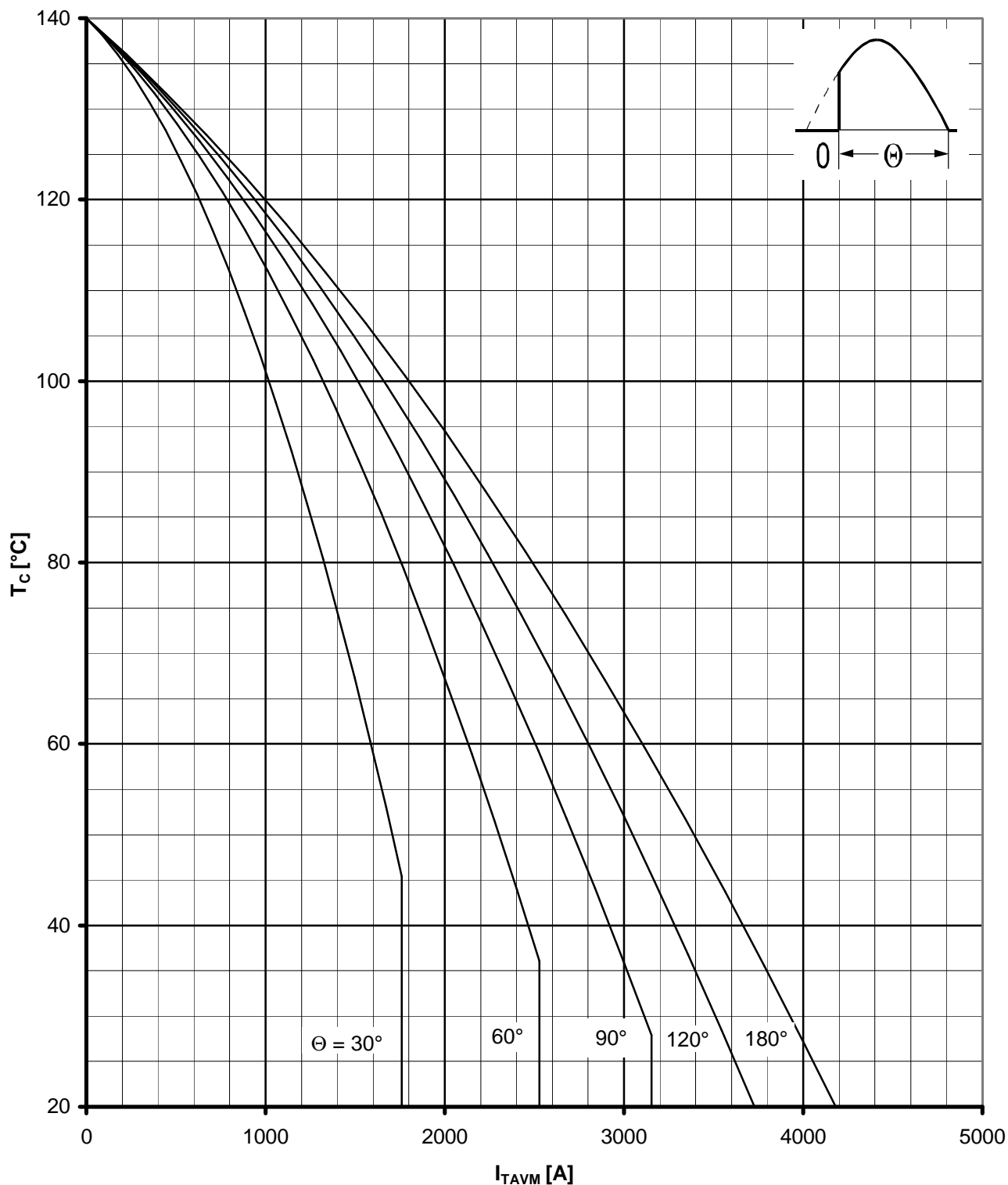
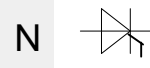

Höchstzulässige Gehäusetemperatur / Maximum allowable case temperature $T_c = f(I_{TAVM})$

Anodenseitige Kühlung / anode sided cooling

Parameter: Stromflußwinkel θ / current conduction angle θ

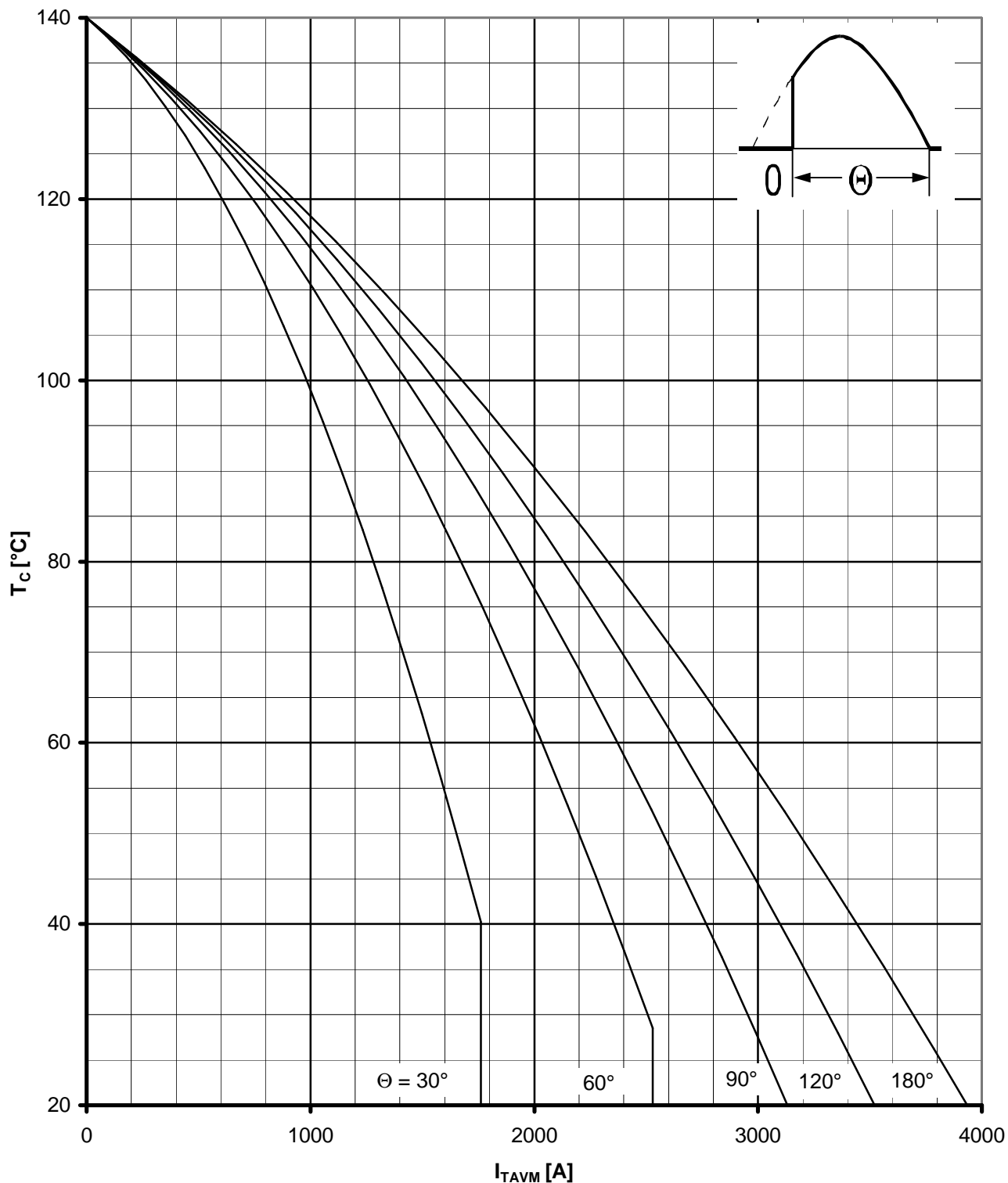

Höchstzulässige Gehäusetemperatur / Maximum allowable case temperature $T_c = f(I_{TAVM})$

Kathodenseitige Kühlung / cathode sided cooling

Parameter: Stromflußwinkel θ / current conduction angle θ

Netz-Thyristor
Phase Control Thyristor

T 3709 N 02...04

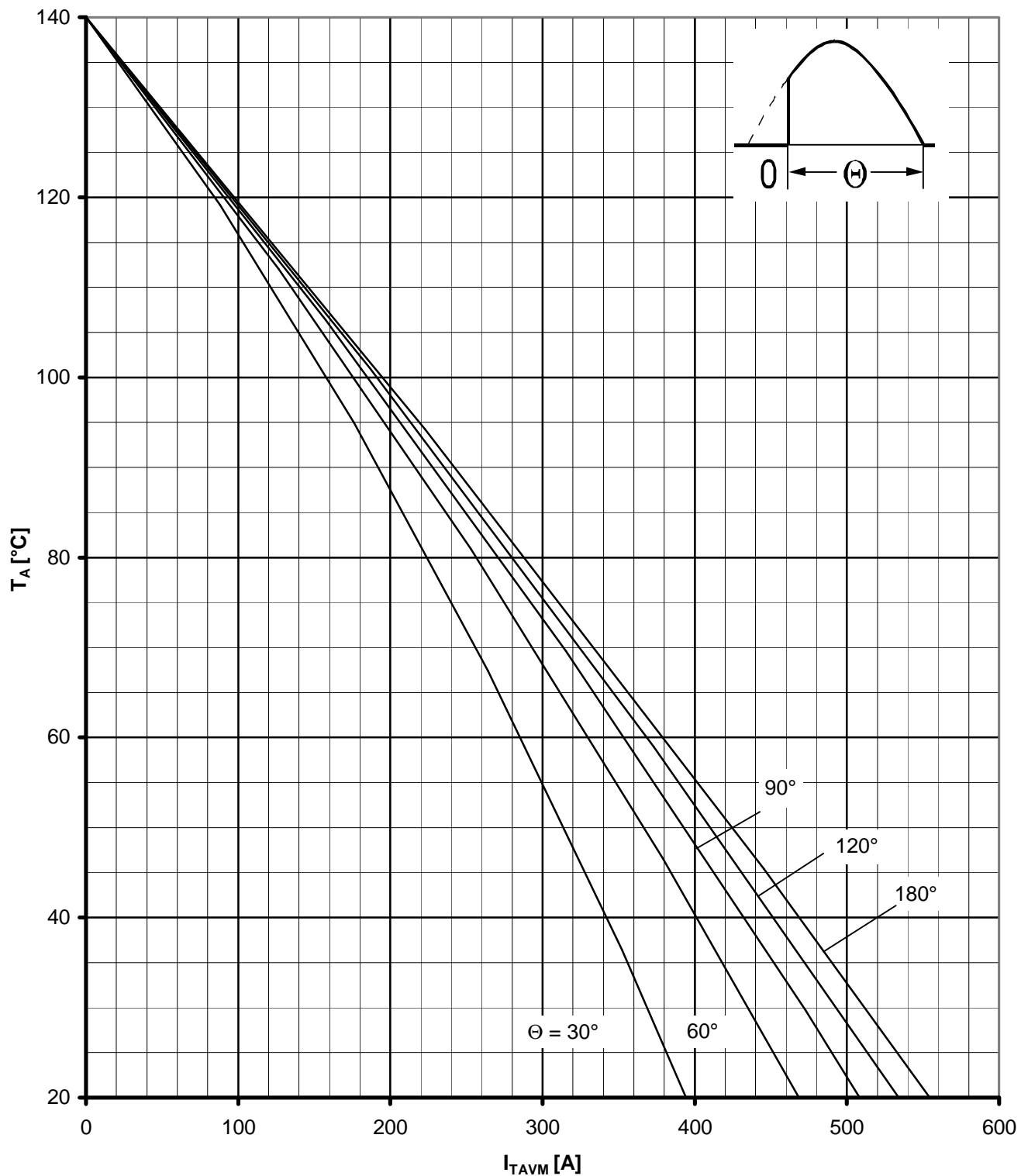
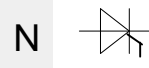

Höchstzulässige Kühlmitteltemperatur / Max. allowable cooling medium temperature $T_A = f(I_{TAVM})$

Luftselbstkühlung / Natural air-cooling

Kühlkörper/Heatsink. K0.048F

Parameter: Stromflußwinkel θ / current conduction angle θ

Netz-Thyristor
Phase Control Thyristor

T 3709 N 02...04

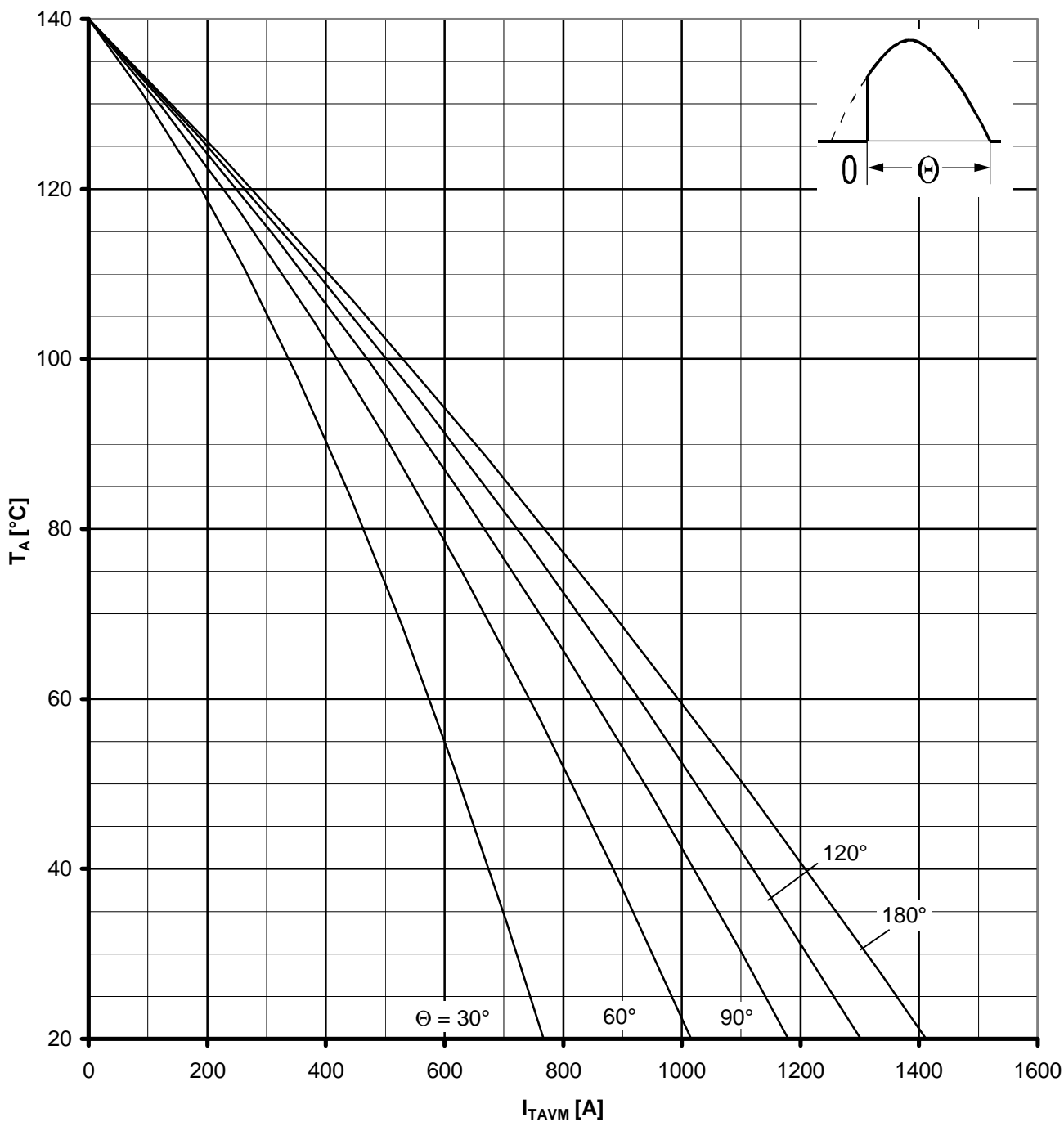
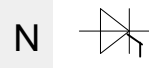

Höchstzulässige Kühlmitteltemperatur / Max. allowable cooling medium temperature $T_A = f(I_{TAVM})$

Verstärkte Luftkühlung / Forced air-cooling

Kühlkörper/Heatsink. K0.048F, $T_A = 35$ °C, $V_L = 120$ l/s

Parameter: Stromflußwinkel θ / current conduction angle θ

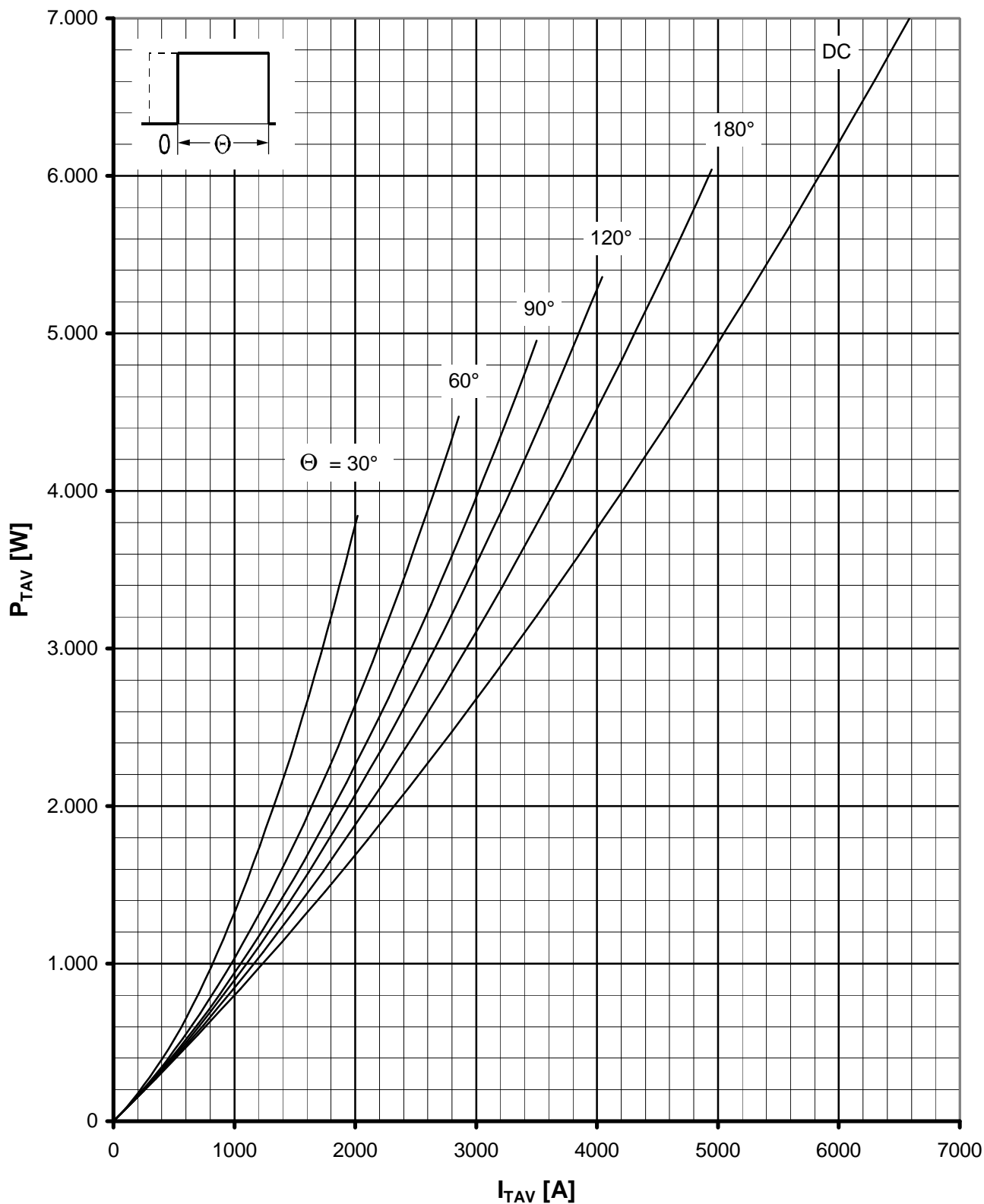

Durchlaßverlustleistung / On-state power loss $P_{TAV} = f(I_{TAV})$
 Parameter: Stromflußwinkel Θ / current conduction angle Θ

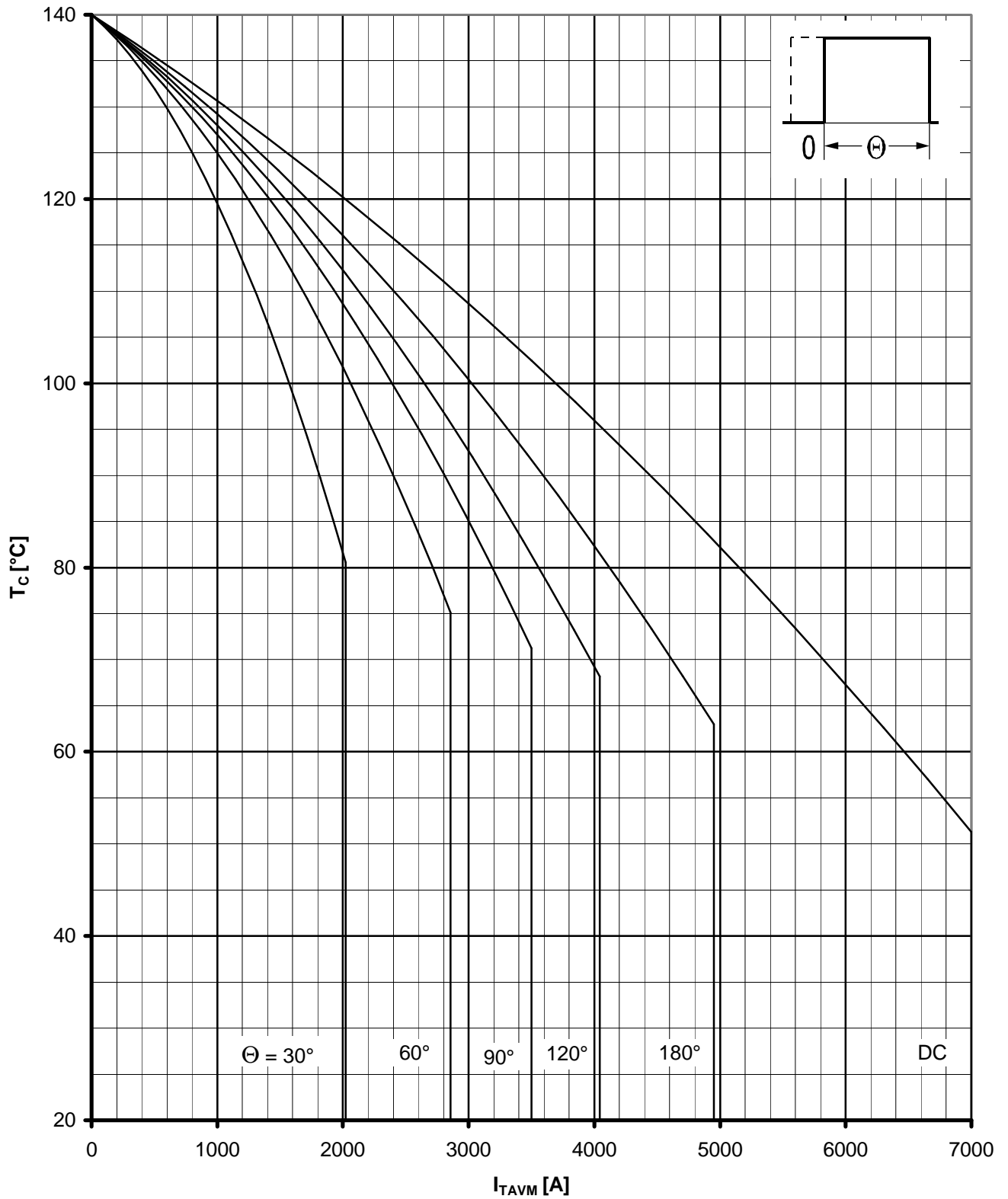

Höchstzulässige Gehäusetemperatur / Maximum allowable case temperature $T_C = f(I_{TAVM})$

Beidseitige Kühlung / Two-sided cooling

Parameter: Stromflußwinkel Θ / current conduction angle Θ

Netz-Thyristor
Phase Control Thyristor

T 3709 N 02...04

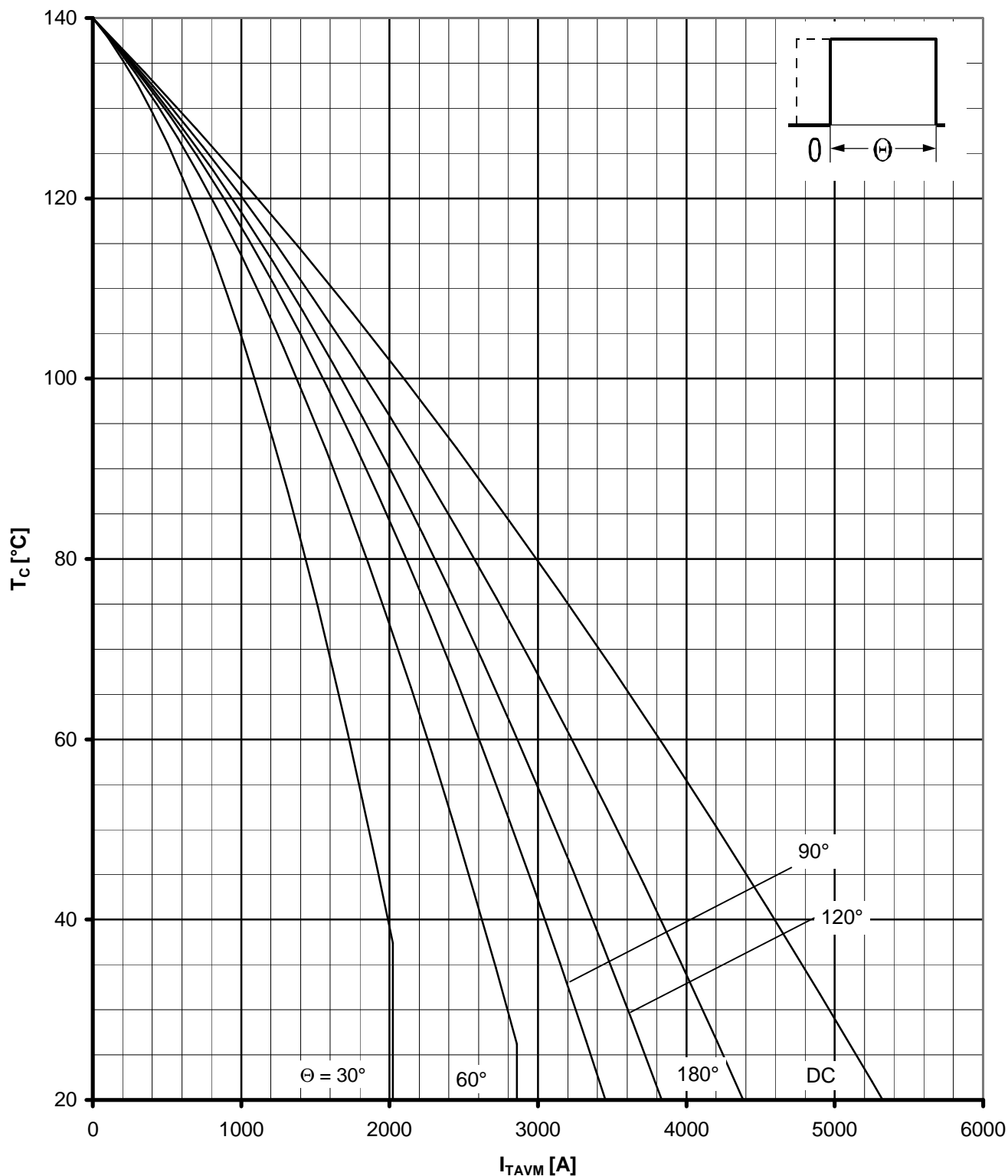
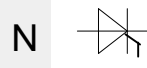

Höchstzulässige Gehäusetemperatur / Maximum allowable case temperature $T_c = f(I_{TAVM})$

Anodenseitige Kühlung / anode sided cooling

Parameter: Stromflußwinkel θ / current conduction angle θ

Netz-Thyristor
Phase Control Thyristor

T 3709 N 02...04

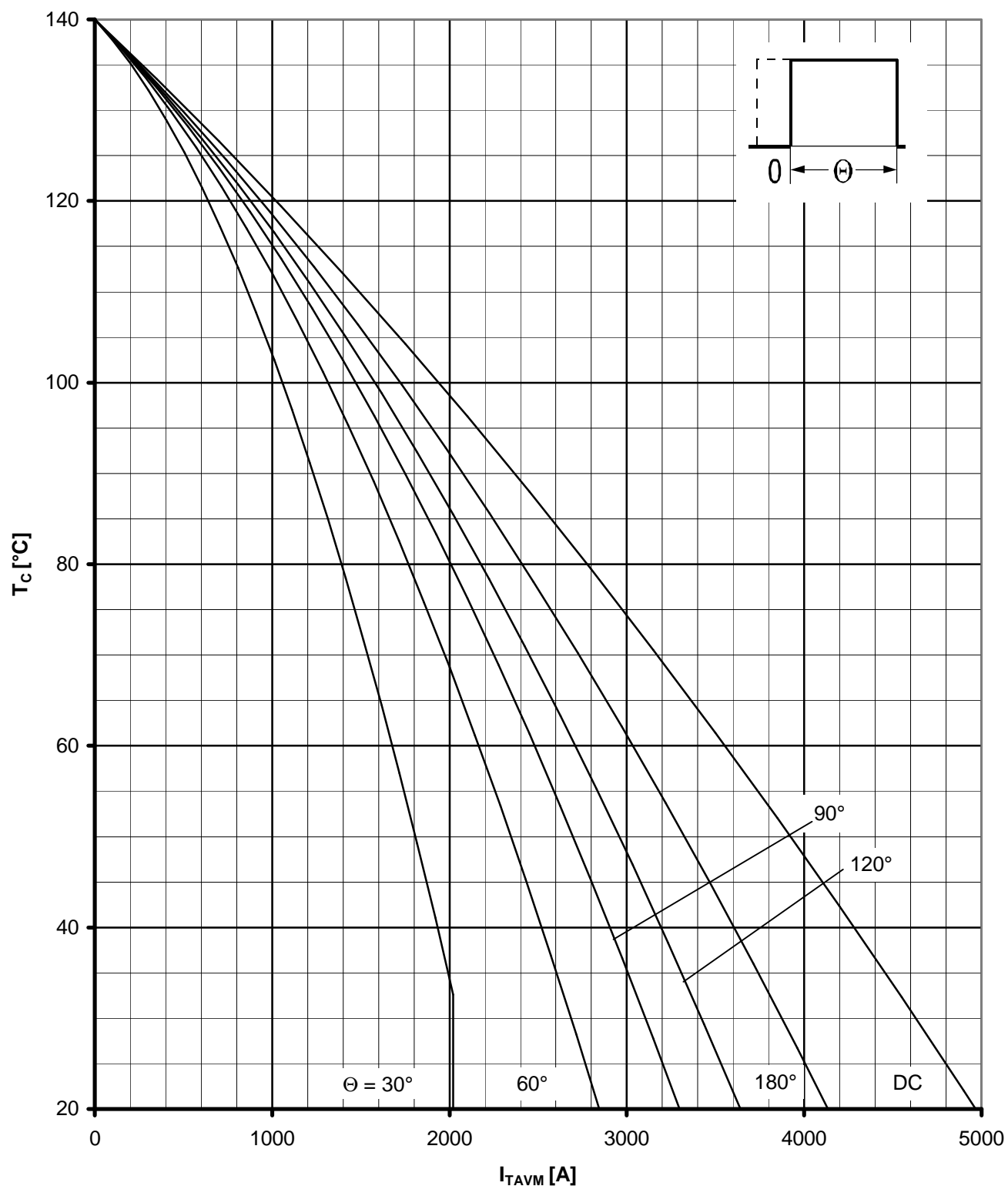

Höchstzulässige Gehäusetemperatur / Maximum allowable case temperature $T_c = f(I_{TAVM})$

Kathodenseitige Kühlung / cathode sided cooling

Parameter: Stromflußwinkel θ / current conduction angle θ

Netz-Thyristor
Phase Control Thyristor

T 3709 N 02...04

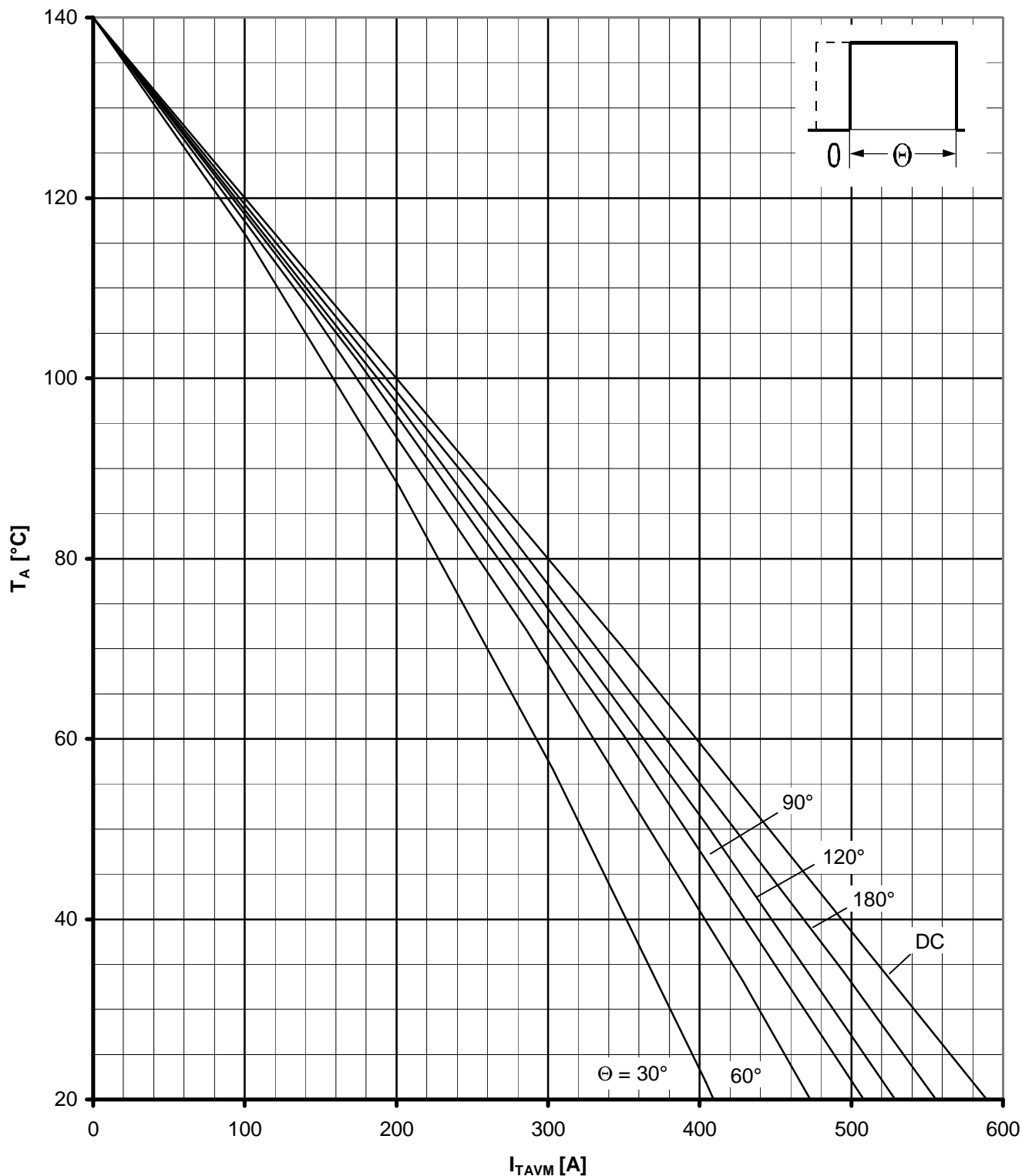
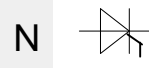

Höchstzulässige Kühlmitteltemperatur / Max. allowable cooling medium temperature $T_A = f(I_{TAVM})$

Luftselbstkühlung / Natural air-cooling

Kühlkörper/Heatsink. K0.048F

Parameter: Stromflußwinkel θ / current conduction angle θ

Netz-Thyristor
Phase Control Thyristor

T 3709 N 02...04

N

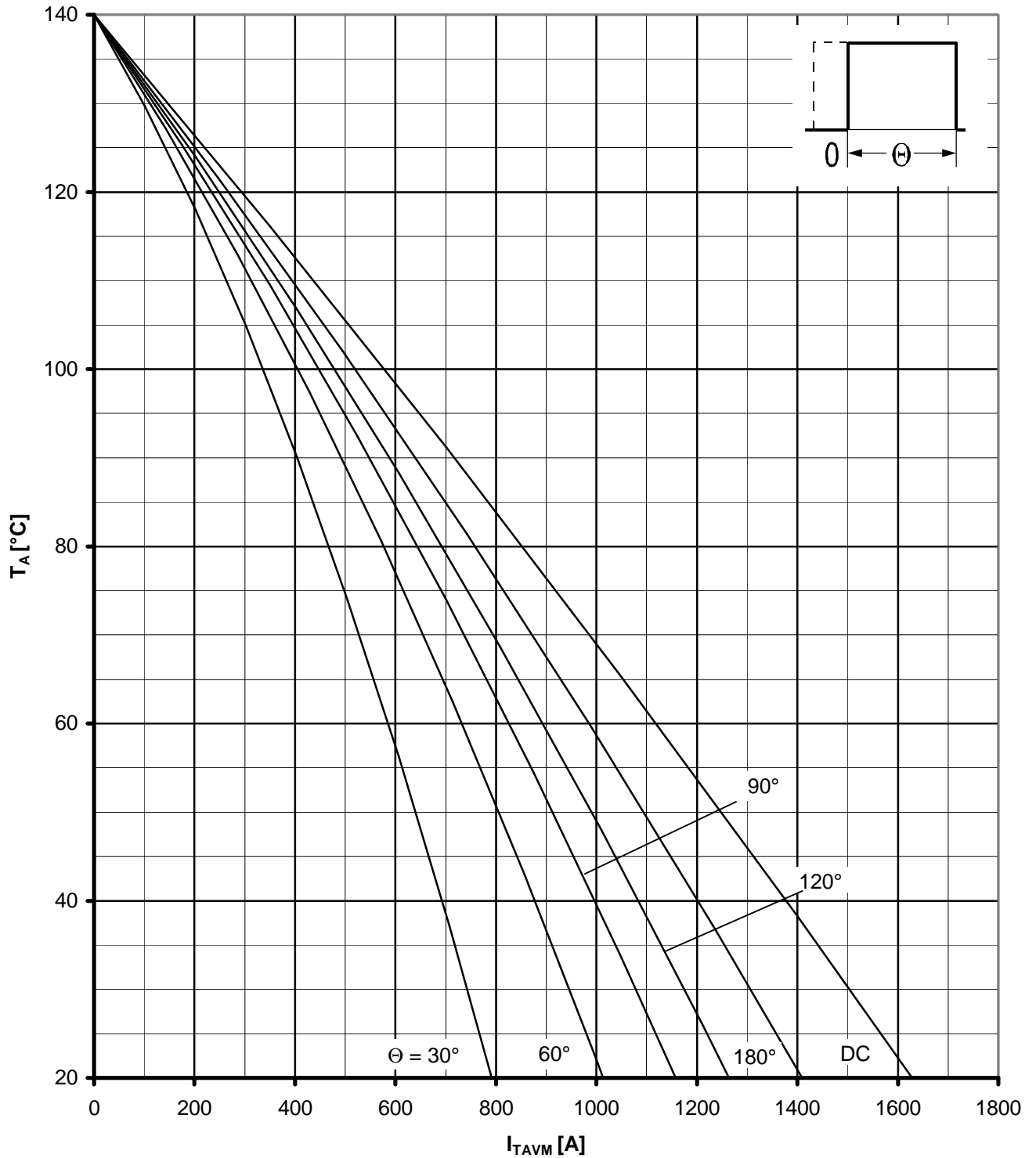

Höchstzulässige Kühlmitteltemperatur / Max. allowable cooling medium temperature $T_A = f(I_{TAVM})$
 Verstärkte Luftkühlung / Forced air-cooling
 Kühlkörper/Heatsink. K0.048F, $V_L = 120$ l/s
 Parameter: Stromflußwinkel θ / current conduction angle θ

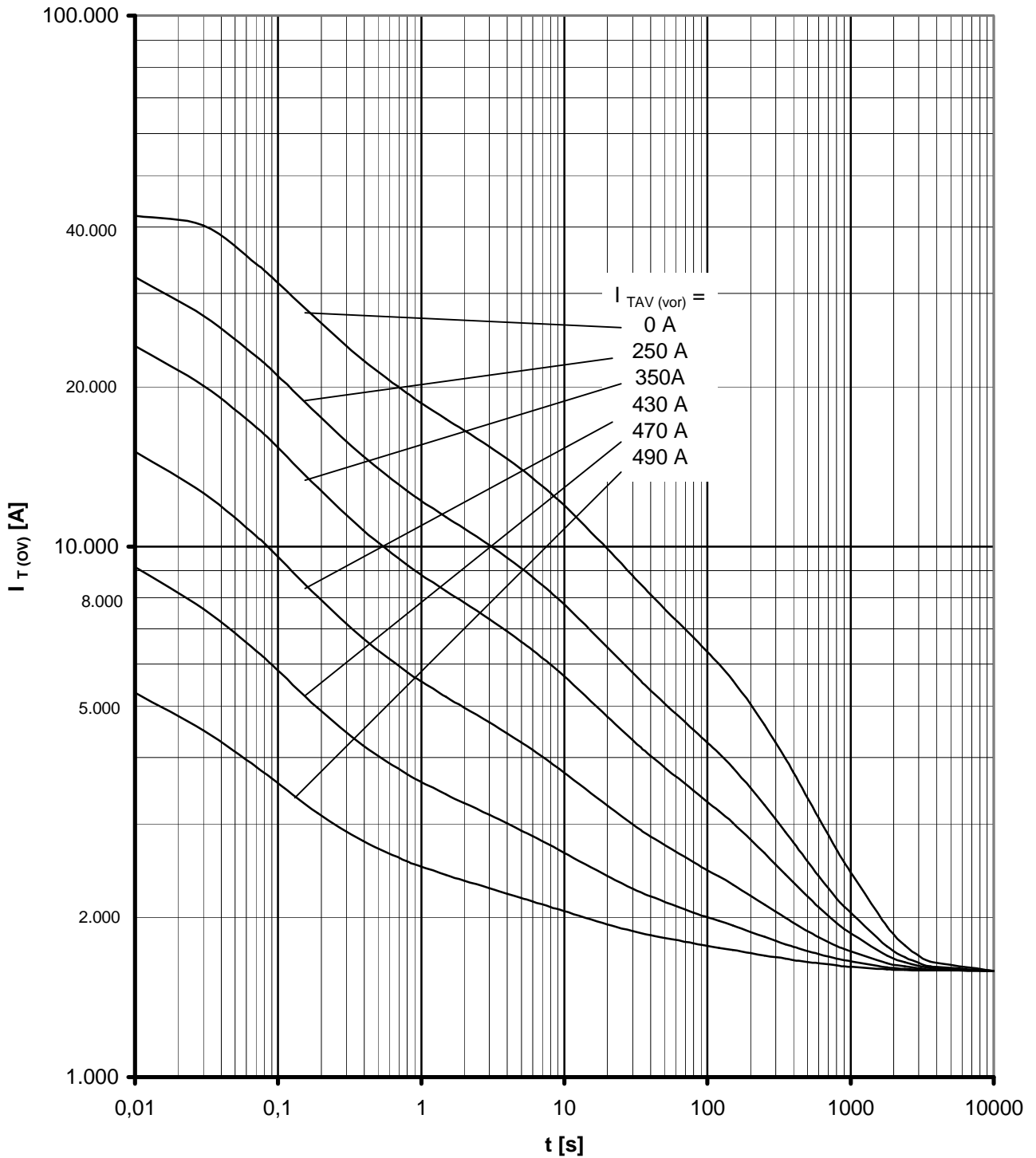

Überstrom / Overload on-state current $I_{T(OV)} = f(t)$

Beidseitige Luftselbstkühlung / Two-sided natural cooling K0.048F

$T_A = 45^\circ\text{C}$

Parameter: Vorlaststrom / pre-load current $I_{TAV(vor)}$

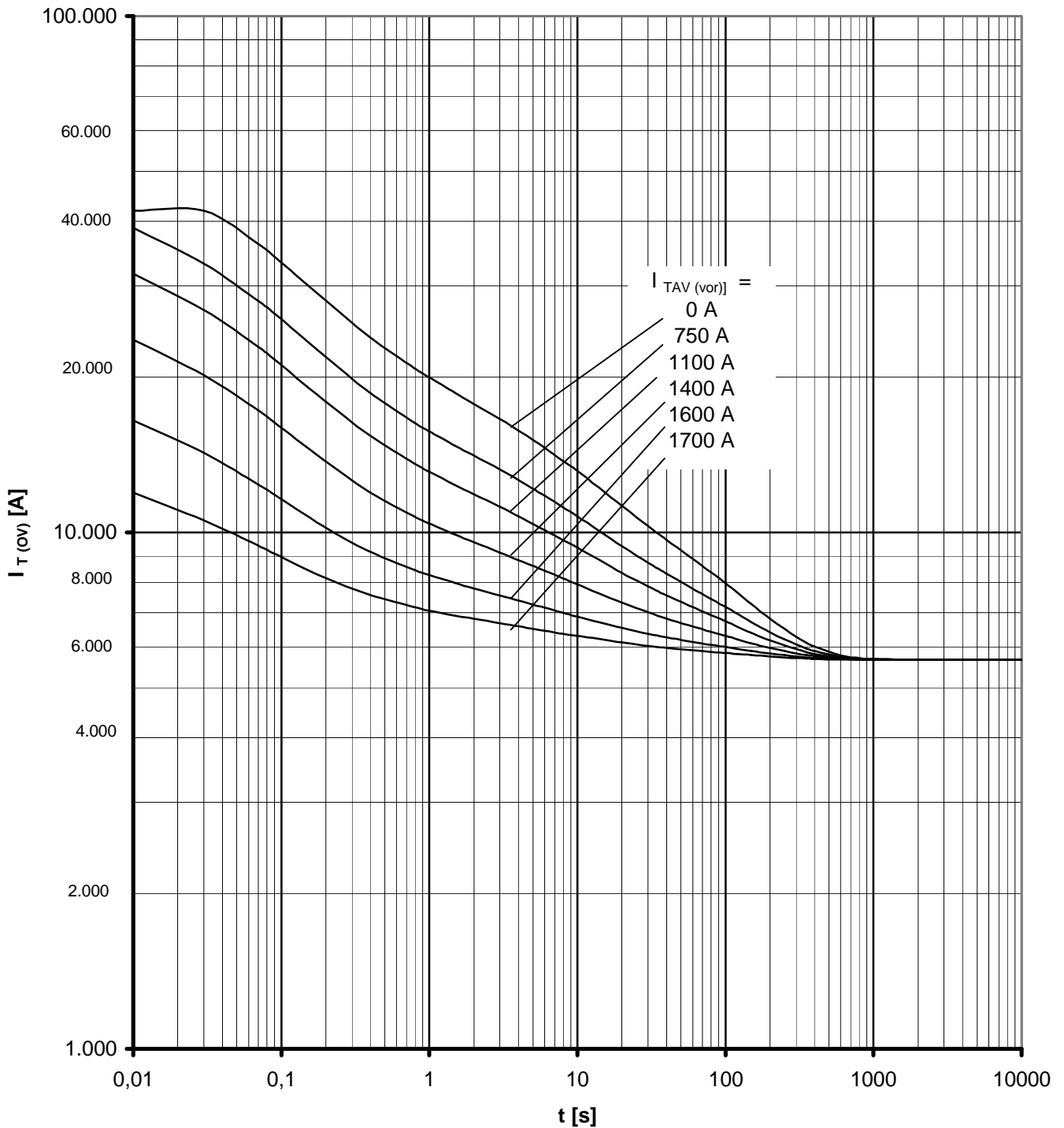

Überstrom / Overload on-state current $I_{T(OV)} = f(t)$

Beidseitige verstärkte Kühlung / forced two-sided cooling K0.048F

$T_A = 35^\circ\text{C}$, $V_L = 120 \text{ l/s}$

Parameter: Vorlaststrom / pre-load current $I_{TAV(vor)}$

Netz-Thyristor
Phase Control Thyristor

T 3709 N 02...04

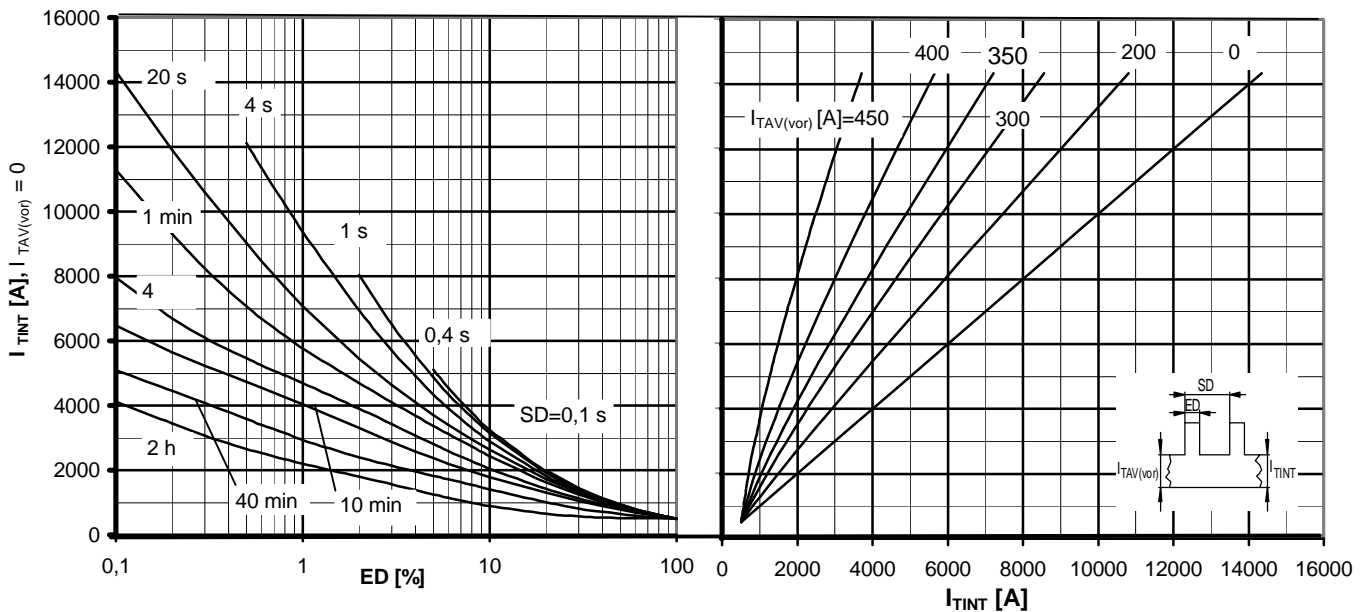
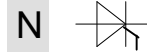

Höchstzul. Durchlaßstrom bei Ausetzbetrieb / Max. allowable on-state current during intermittent operation $I_{TINT} = f(ED)$

Beidseitig Luftselbstkühlung / two-sided natural cooling $K 0.048F$
 $T_A = 45\text{ °C}$

Parameter: Vorlaststrom / pre-load current $I_{TAV(vor)}$, Spieldauer / cycle duration SD

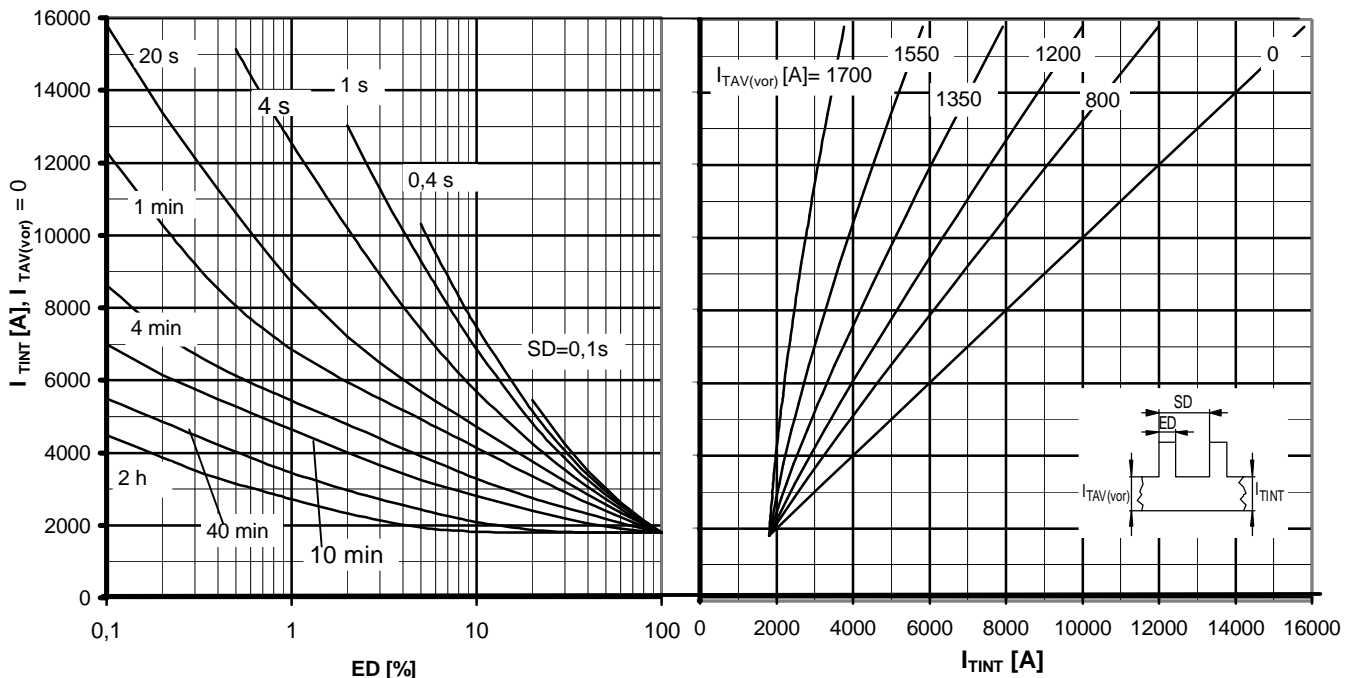

Höchstzul. Durchlaßstrom bei Ausetzbetrieb / Max. allowable on-state current during intermittent operation $I_{TINT} = f(ED)$

Beidseitig verstärkte Kühlung / forced two-sided cooling $K 0.048F$
 $T_A = 35\text{ °C}$, $V_L = 120\text{ l/s}$

Parameter: Vorlaststrom / pre-load current $I_{TAV(vor)}$, Spieldauer / cycle duration SD

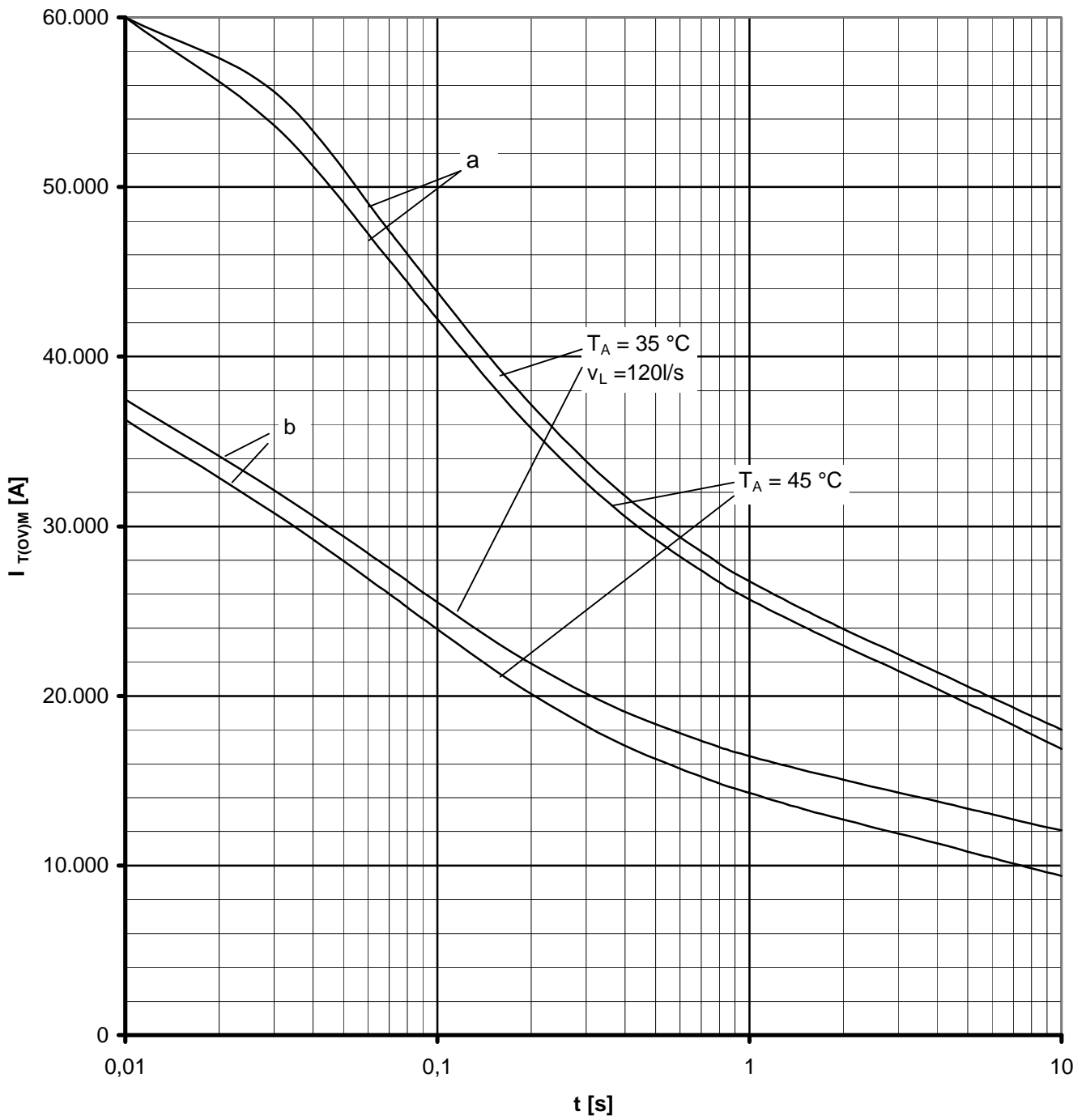

Grenzstrom / Max. overload on-state current $I_{T(OV)M} = f(t)$, $v_{RM} = 0,8 V_{RRM}$

Beidseitige Kühlung / Two-sided cooling

Kühlkörper / Heatsink: K 0.048F

Belastung aus / Surge current occurs:

a - Leerlauf / No-load conditions

b - Betrieb mit Dauergrenzstrom / During operation at max. average on-state current $I_{T(AVM)}$

Netz-Thyristor
Phase Control Thyristor

T 3709 N 02...04

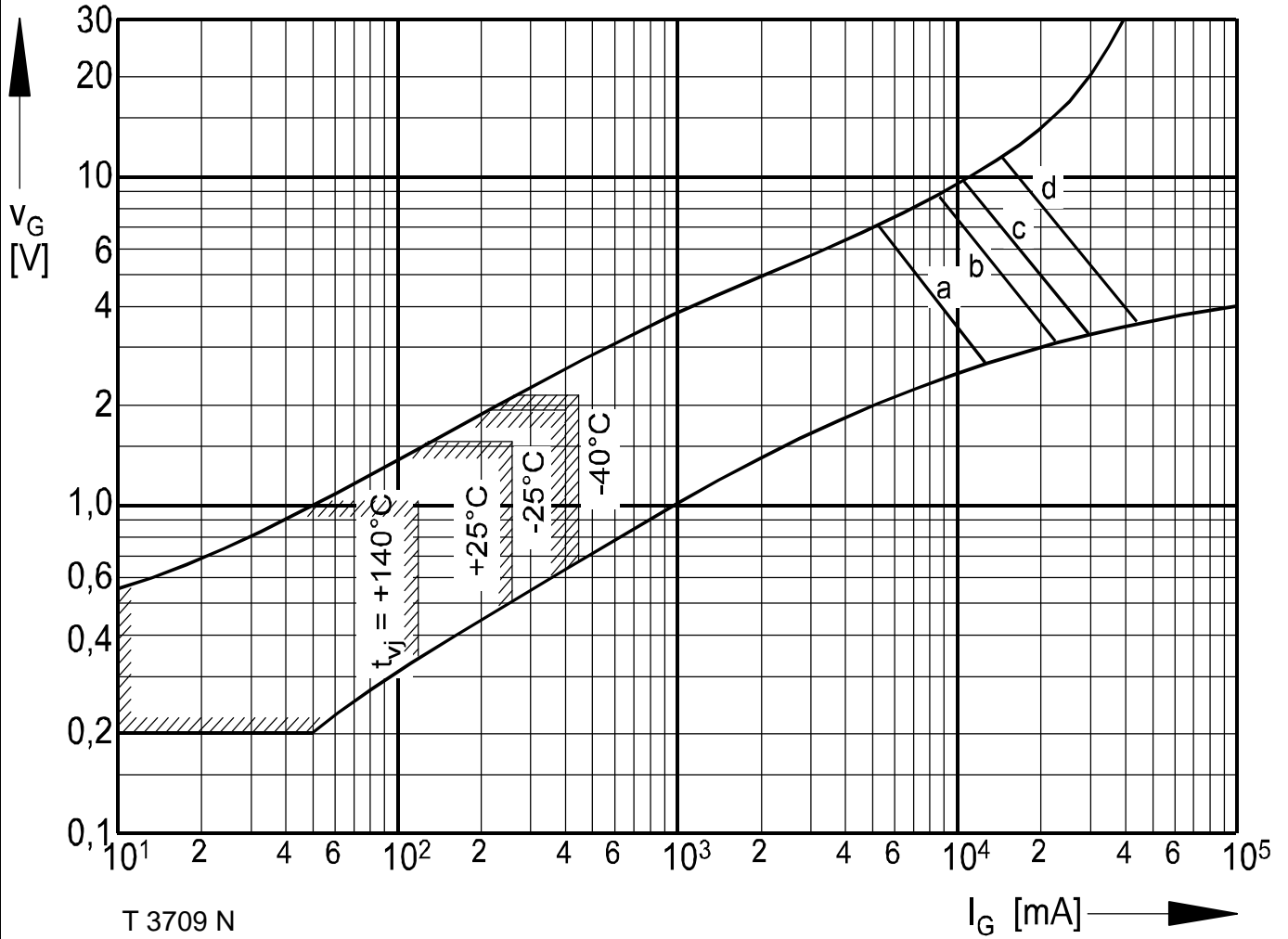

T 3709 N

I_G [mA]

Steuercharakteristik $v_G = f(i_G)$ mit Zündbereichen für $V_D = 6$ V

Gate characteristic $v_G = f(i_G)$ with triggering area for $V_D = 6$ V

Höchstzulässige Spitzensteuerverlustleistung / Maximum rated peak gate power dissipation $P_{GM} = f(t_g)$:

a - 40 W/10ms b - 80 W/1ms c - 100 W/0,5ms d - 150 W/0,1ms

Netz-Thyristor
Phase Control Thyristor

T 3709 N 02...04

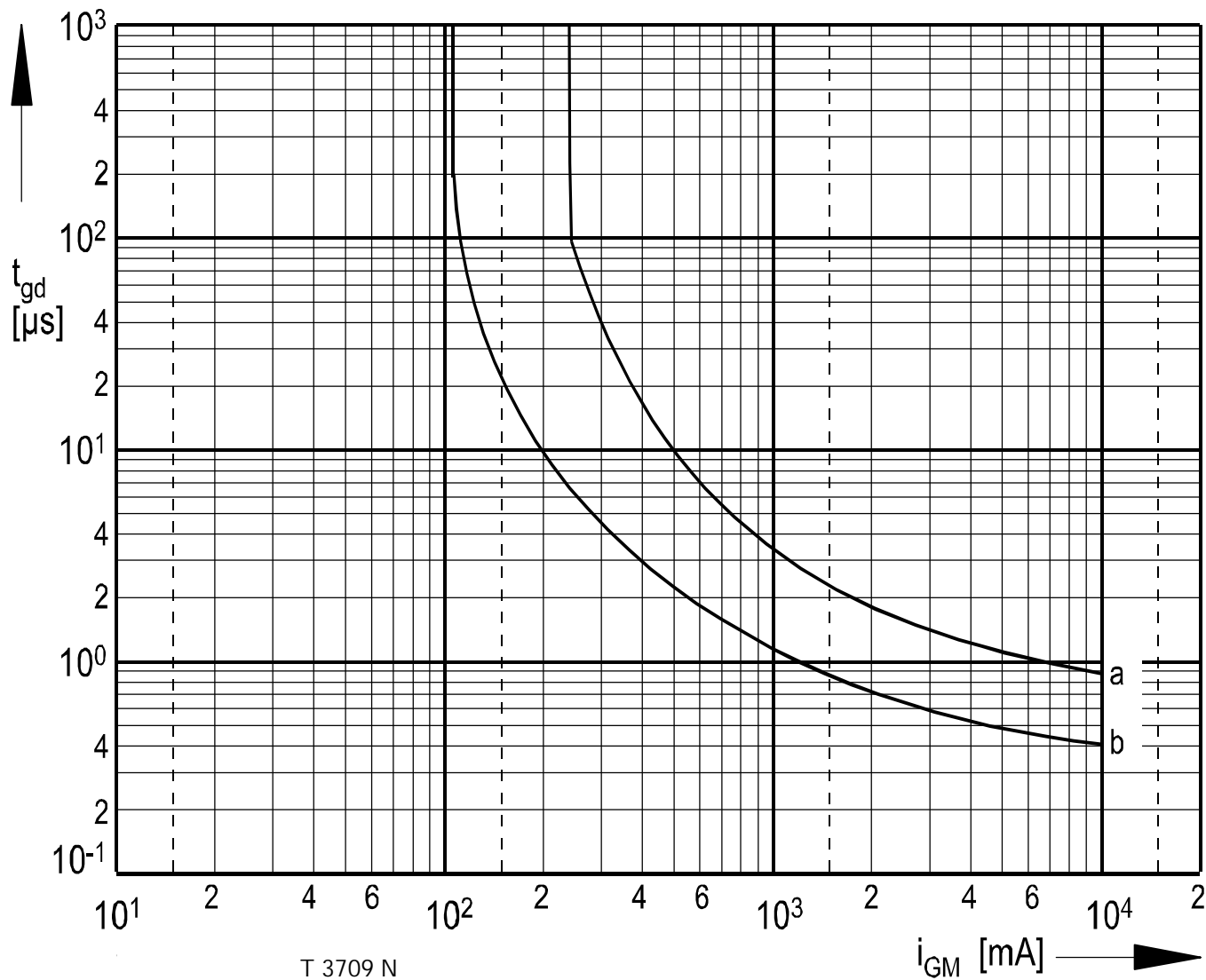
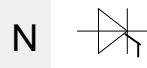

Zündverzögerung / Gate controlled delay time $t_{gd} = f(i_{GM})$

$T_{vj} = 25^\circ\text{C}$, $di_G/dt = i_{GM}/1\mu\text{s}$

a - maximaler Verlauf / limiting characteristic

b - typischer Verlauf / typical characteristic

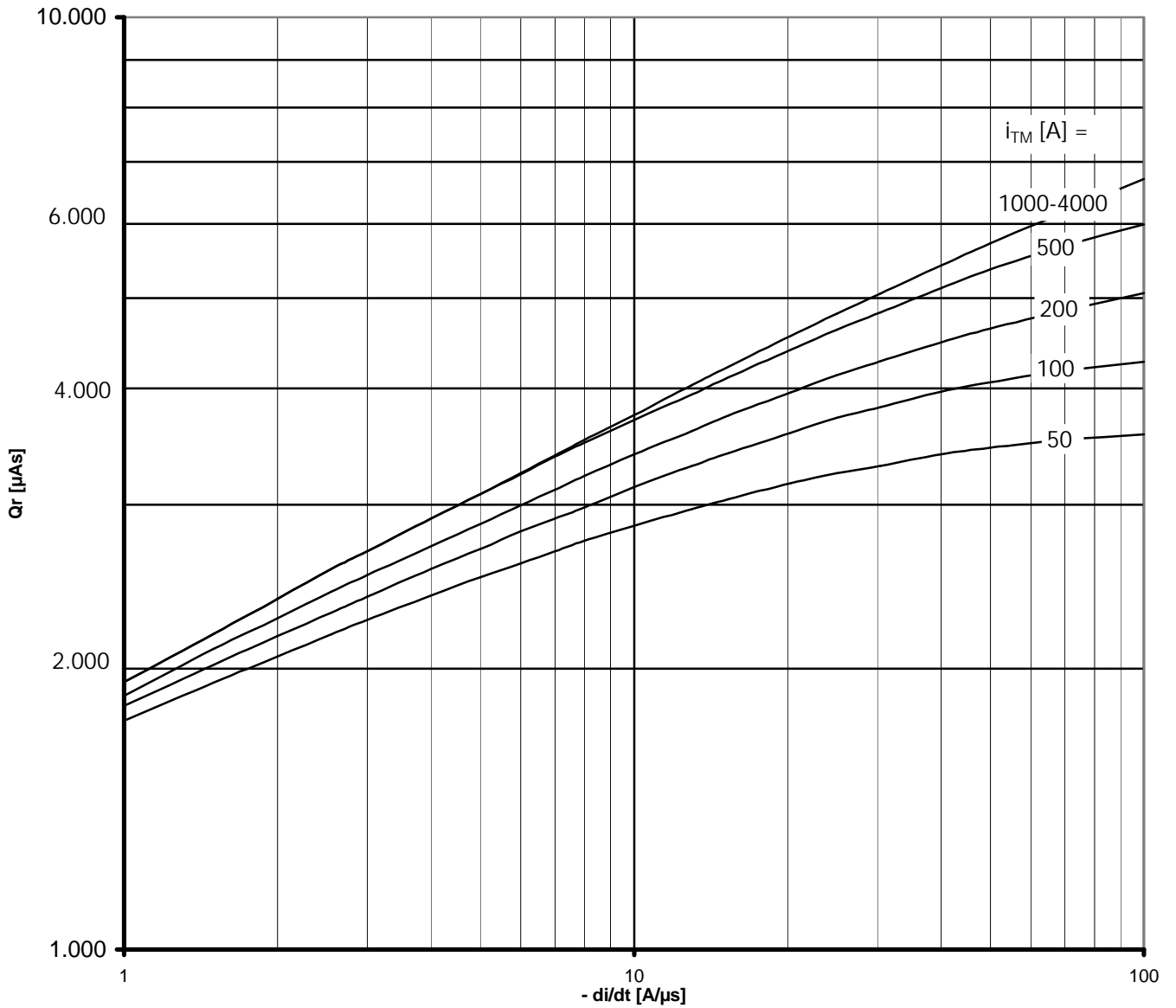

Sperrverzögerungsladung / Recovered charge $Q_r = f(di/dt)$

$T_{vj} = T_{vj} \text{ max}$, $V_R = 0,5 V_{RRM}$, $V_{RM} = 0,8 V_{RRM}$

Parameter: Durchlaßstrom / On-state current i_{TM}

Netz-Thyristor
Phase Control Thyristor

T 3709 N 02...04

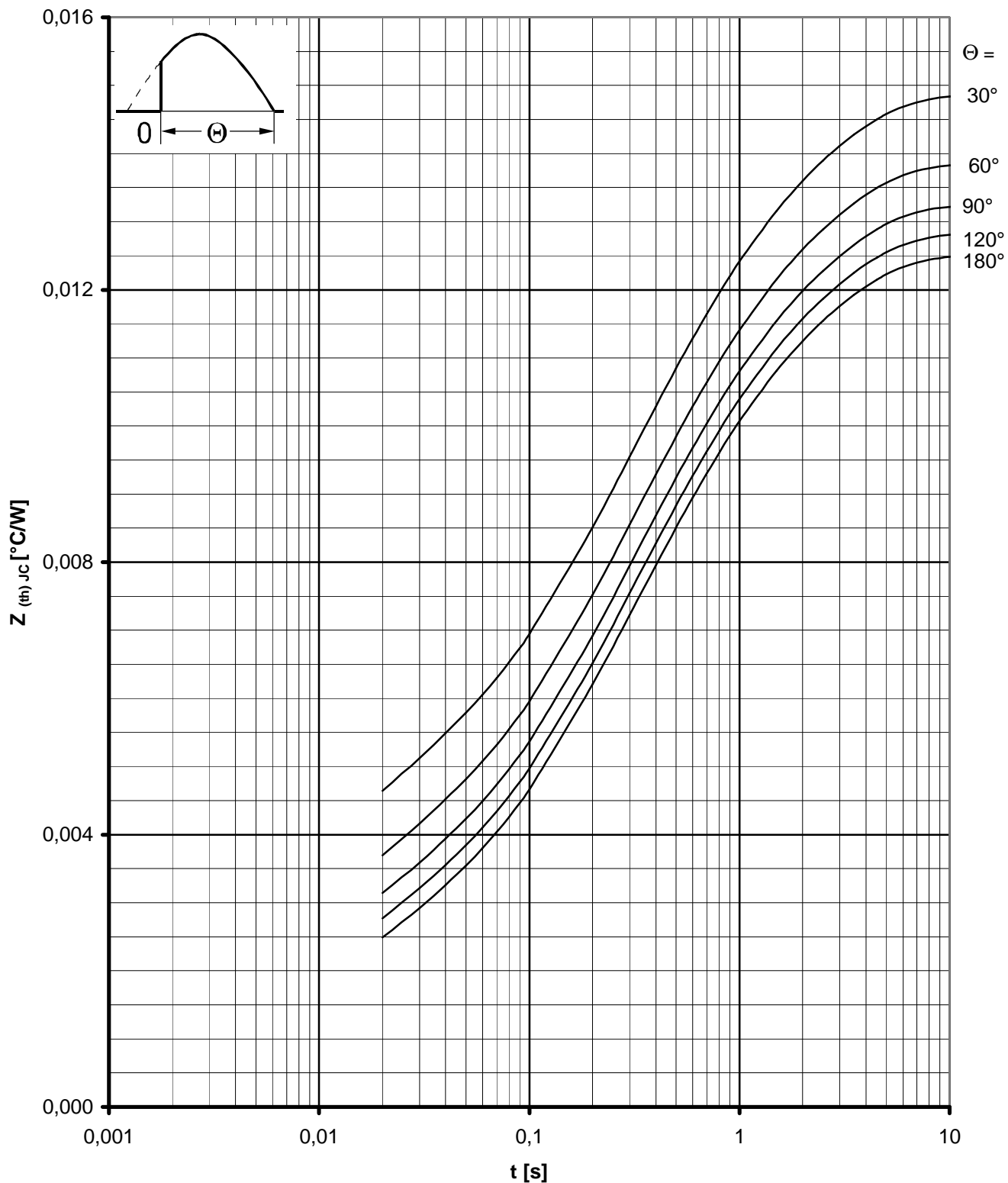

Transienter innerer Wärmewiderstand / Transient thermal impedance $Z_{(th)JC} = f(t)$
 Beidseitige Kühlung / Two-sided cooling
 Parameter: Stromflußwinkel Θ / current conduction angle Θ

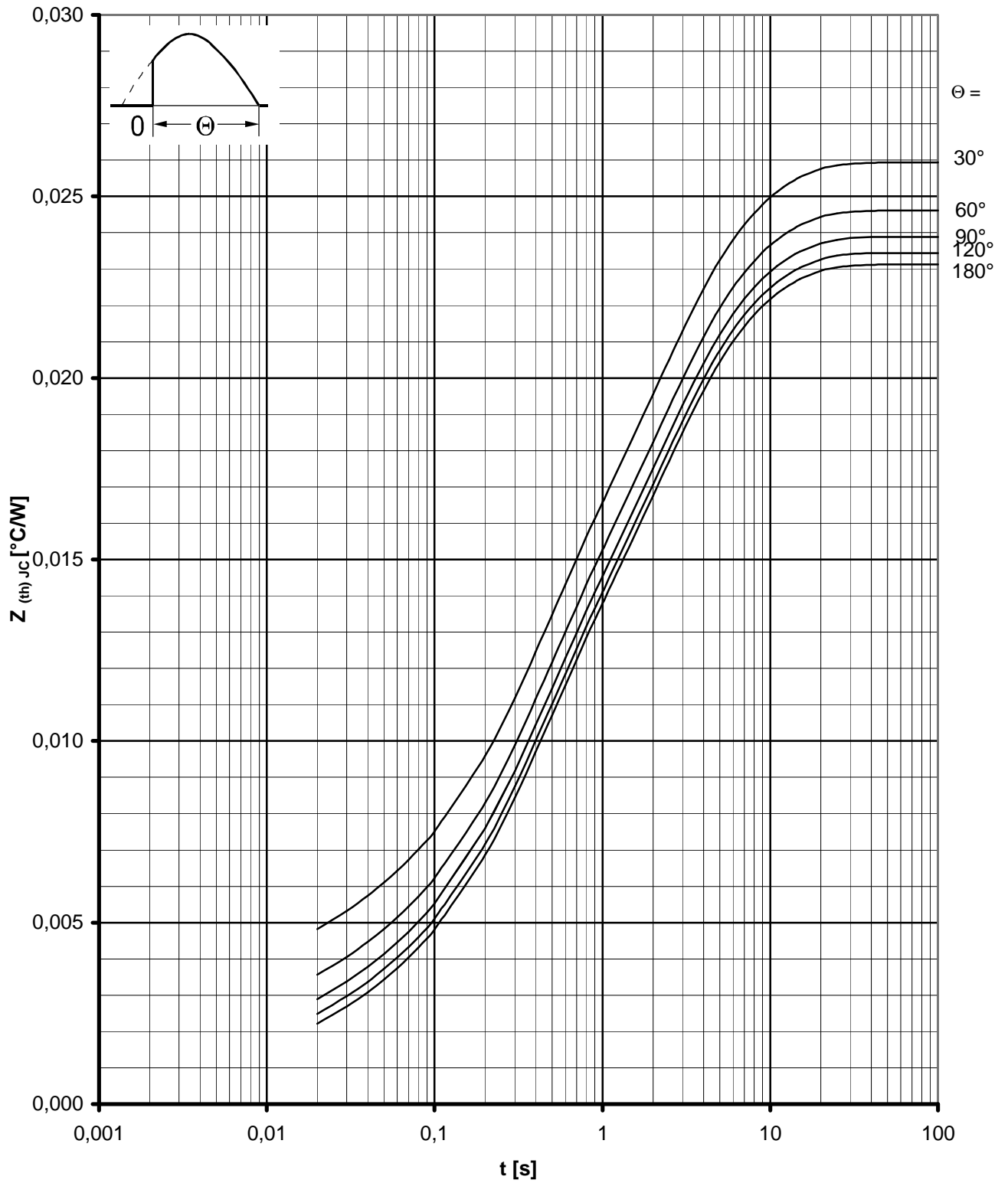

Transienter innerer Wärmewiderstand / Transient thermal impedance $Z_{(th)JC} = f(t)$
 Anodenseitige Kühlung / Anode-sided cooling
 Parameter: Stromflußwinkel Θ / current conduction angle Θ

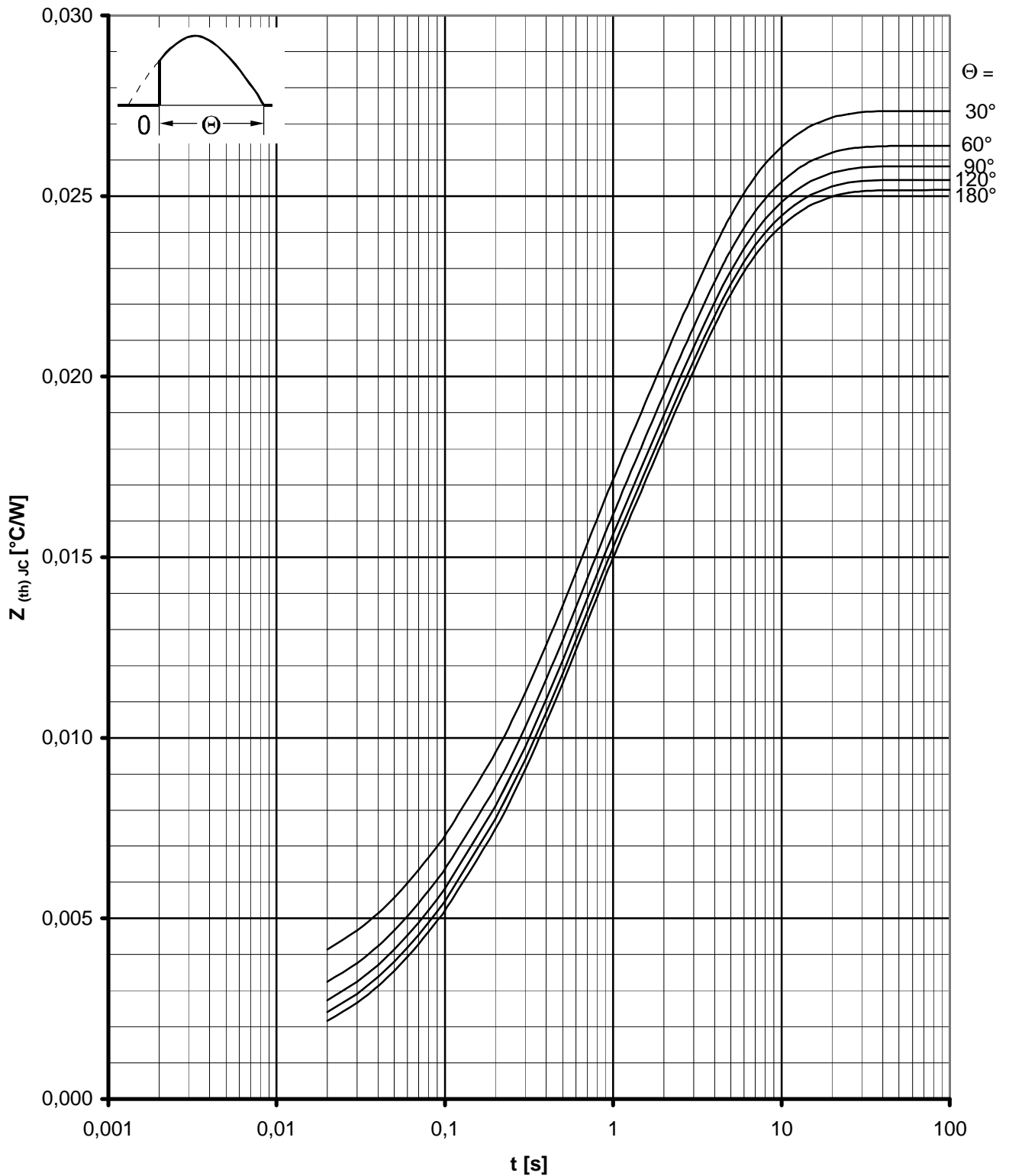

Transienter innerer Wärmewiderstand / Transient thermal impedance $Z_{(th)JC} = f(t)$

Kathodenseitige Kühlung / Cathode-sided cooling

Parameter: Stromflußwinkel Θ / current conduction angle Θ

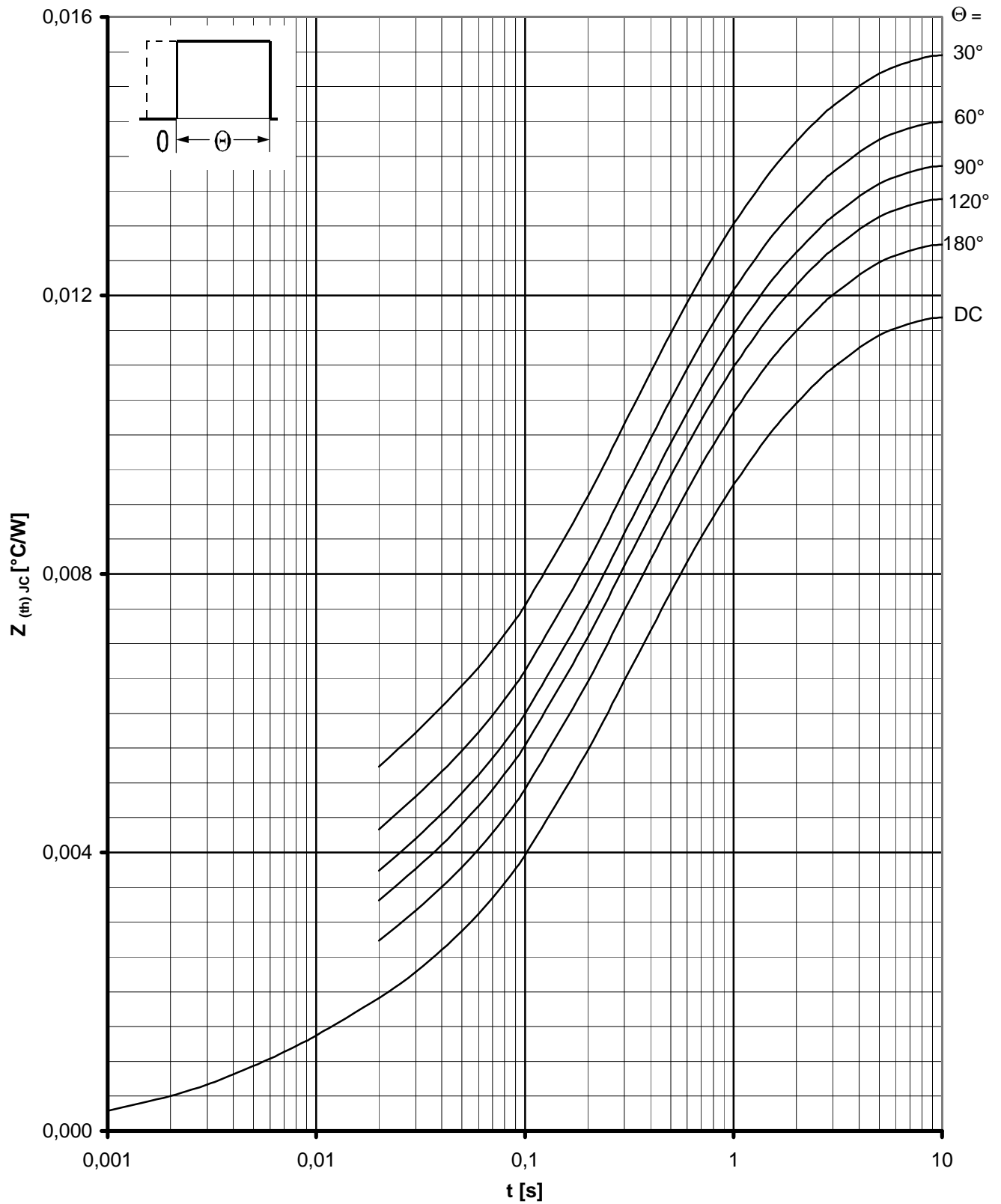

Transienter innerer Wärmewiderstand / Transient thermal impedance $Z_{(th)JC} = f(t)$
 Beidseitige Kühlung / Two-sided cooling
 Parameter: Stromflußwinkel Θ / current conduction angle Θ

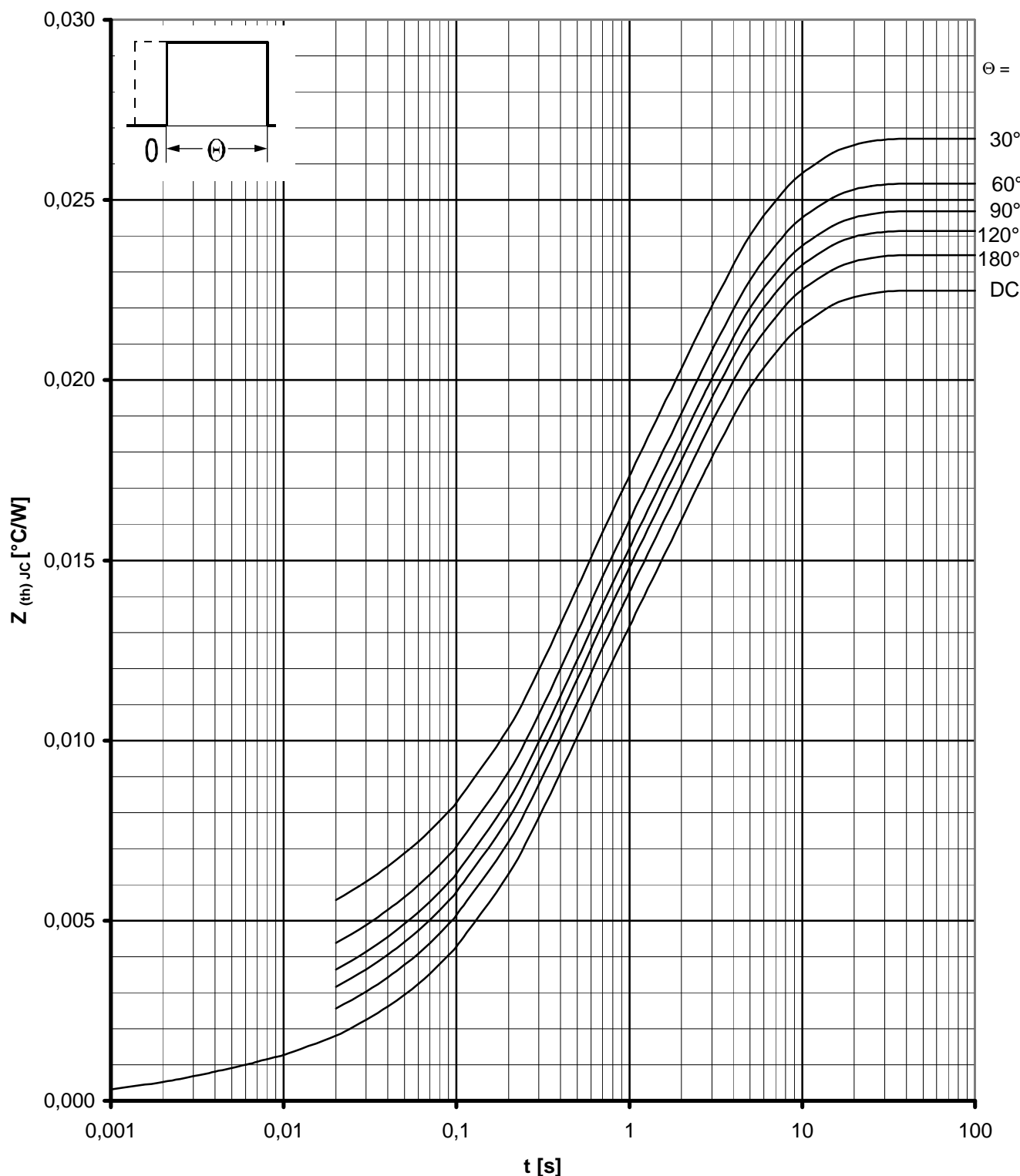

Transienter innerer Wärmewiderstand / Transient thermal impedance $Z_{(th)JC} = f(t)$

Anodenseitige Kühlung / Anode-sided cooling

Parameter: Stromflußwinkel θ / current conduction angle θ

Netz-Thyristor
Phase Control Thyristor

T 3709 N 02...04

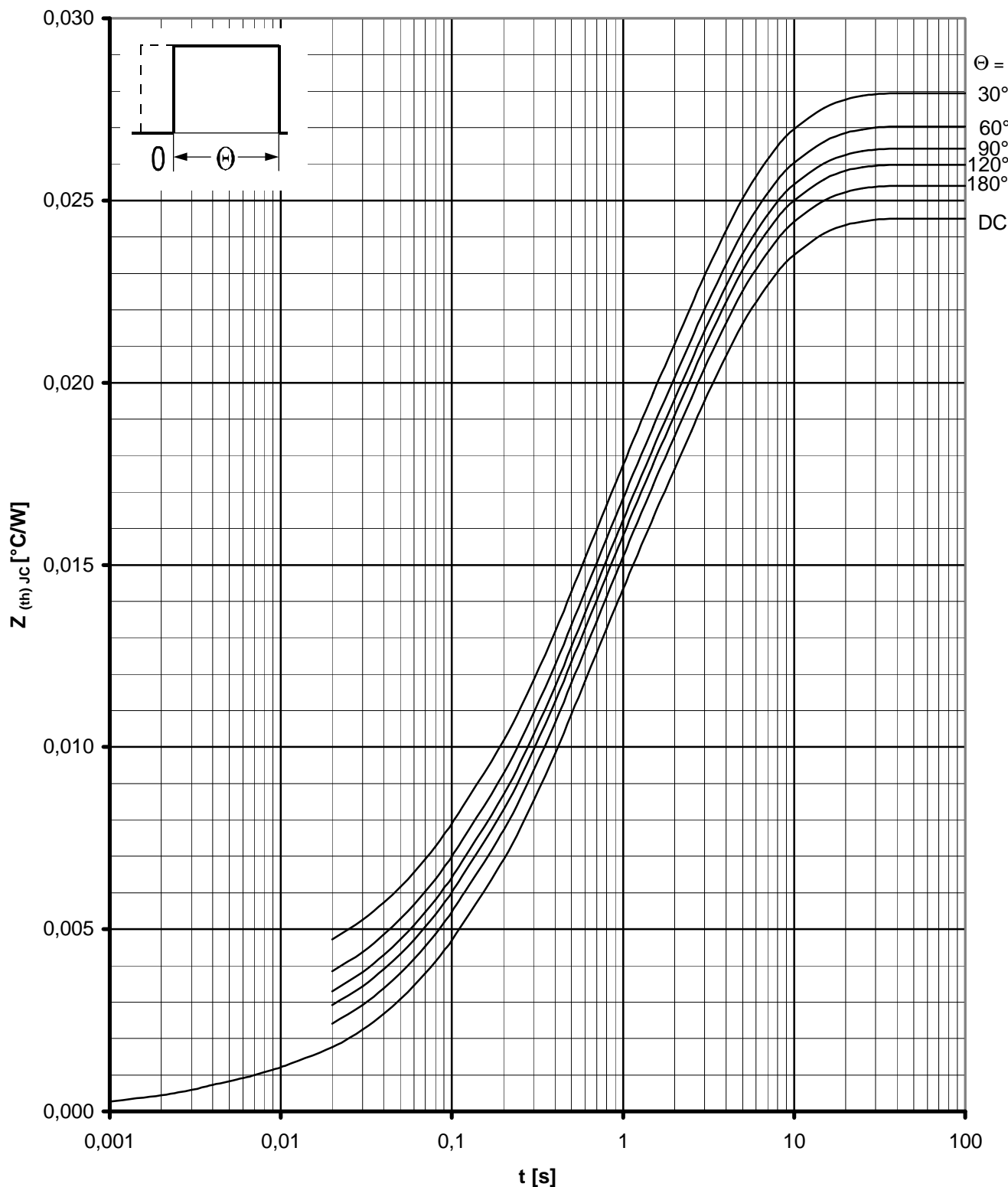

Transienter innerer Wärmewiderstand / Transient thermal impedance $Z_{(th)JC} = f(t)$
 Kathodenseitige Kühlung / Cathode-sided cooling
 Parameter: Stromflußwinkel Θ / current conduction angle Θ

Nutzungsbedingungen

Die in diesem Produktdatenblatt enthaltenen Daten sind ausschließlich für technisch geschultes Fachpersonal bestimmt. Die Beurteilung der Geeignetheit dieses Produktes für die von Ihnen anvisierte Anwendung sowie die Beurteilung der Vollständigkeit der bereitgestellten Produktdaten für diese Anwendung obliegt Ihnen bzw. Ihren technischen Abteilungen.

In diesem Produktdatenblatt werden diejenigen Merkmale beschrieben, für die wir eine liefervertragliche Gewährleistung übernehmen. Eine solche Gewährleistung richtet sich ausschließlich nach Maßgabe der im jeweiligen Liefervertrag enthaltenen Bestimmungen. Garantien jeglicher Art werden für das Produkt und dessen Eigenschaften keinesfalls übernommen.

Sollten Sie von uns Produktinformationen benötigen, die über den Inhalt dieses Produktdatenblatts hinausgehen und insbesondere eine spezifische Verwendung und den Einsatz dieses Produktes betreffen, setzen Sie sich bitte mit dem für Sie zuständigen Vertriebsbüro in Verbindung (siehe www.eupec.com, Vertrieb&Kontakt). Für Interessenten halten wir Application Notes bereit.

Aufgrund der technischen Anforderungen könnte unser Produkt gesundheitsgefährdende Substanzen enthalten. Bei Rückfragen zu den in diesem Produkt jeweils enthaltenen Substanzen setzen Sie sich bitte ebenfalls mit dem für Sie zuständigen Vertriebsbüro in Verbindung.

Sollten Sie beabsichtigen, das Produkt in Anwendungen der Luftfahrt, in gesundheits- oder lebensgefährdenden oder lebenserhaltenden Anwendungsbereichen einzusetzen, bitten wir um Mitteilung. Wir weisen darauf hin, dass wir für diese Fälle

- die gemeinsame Durchführung eines Risiko- und Qualitätsassessments;
- den Abschluss von speziellen Qualitätssicherungsvereinbarungen;
- die gemeinsame Einführung von Maßnahmen zu einer laufenden Produktbeobachtung dringend empfehlen und gegebenenfalls die Belieferung von der Umsetzung solcher Maßnahmen abhängig machen.

Soweit erforderlich, bitten wir Sie, entsprechende Hinweise an Ihre Kunden zu geben.

Inhaltliche Änderungen dieses Produktdatenblatts bleiben vorbehalten.

Terms & Conditions of usage

The data contained in this product data sheet is exclusively intended for technically trained staff. You and your technical departments will have to evaluate the suitability of the product for the intended application and the completeness of the product data with respect to such application.

This product data sheet is describing the characteristics of this product for which a warranty is granted. Any such warranty is granted exclusively pursuant the terms and conditions of the supply agreement. There will be no guarantee of any kind for the product and its characteristics.

Should you require product information in excess of the data given in this product data sheet or which concerns the specific application of our product, please contact the sales office, which is responsible for you (see www.eupec.com, sales&contact). For those that are specifically interested we may provide application notes.

Due to technical requirements our product may contain dangerous substances. For information on the types in question please contact the sales office, which is responsible for you.

Should you intend to use the Product in aviation applications, in health or life endangering or life support applications, please notify.

Please note, that for any such applications we urgently recommend

- to perform joint Risk and Quality Assessments;
- the conclusion of Quality Agreements;
- to establish joint measures of an ongoing product survey, and that we may make delivery depended on the realization of any such measures.

If and to the extent necessary, please forward equivalent notices to your customers.

Changes of this product data sheet are reserved.